

<QF>FANTA2

<QF>TA1

<QF>FU

TA1<QF>TA2

TA2TA1<QF>

OFTOF

QFKMV

<QF>FANTA2

<QF>TA1

<QF>FU

TA1<QF>TA2

TA2TA1<QF>

OFTOF

QFKMV

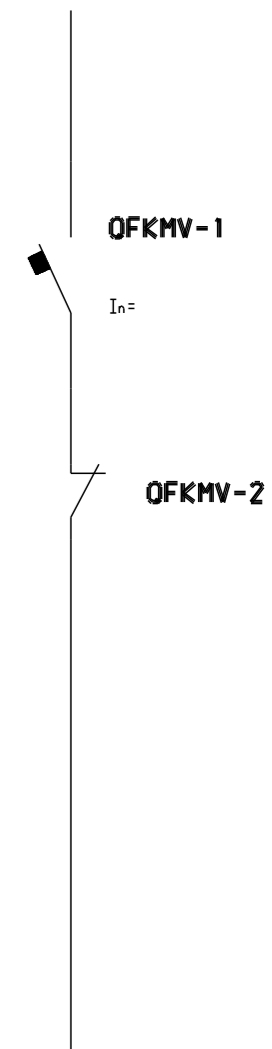
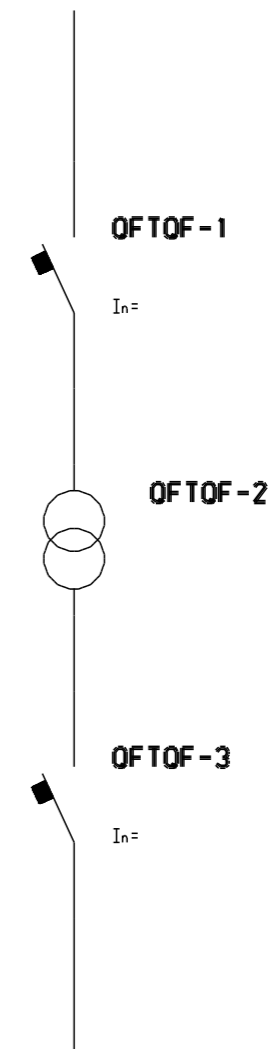
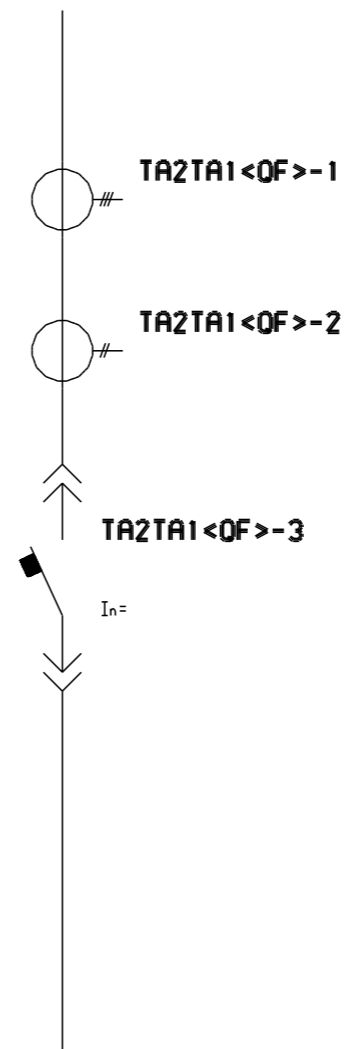
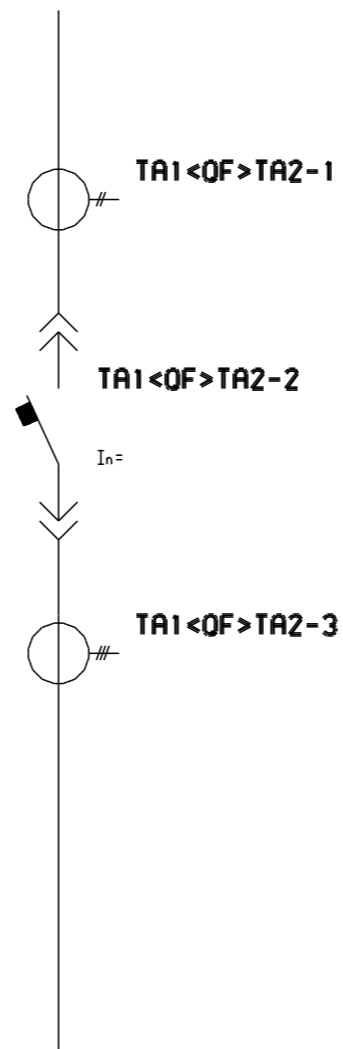
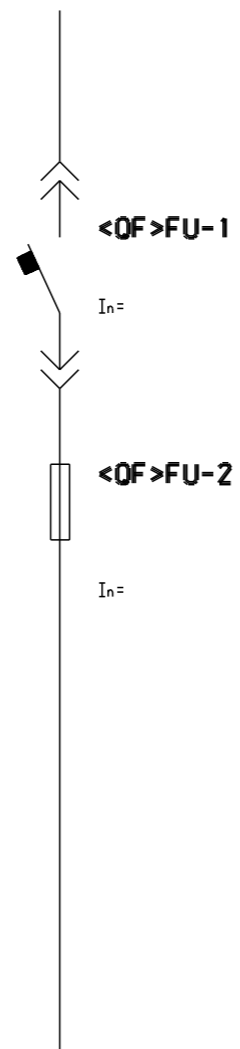
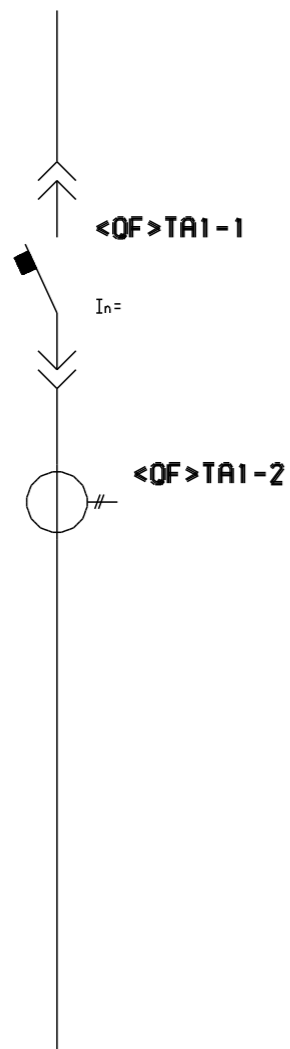
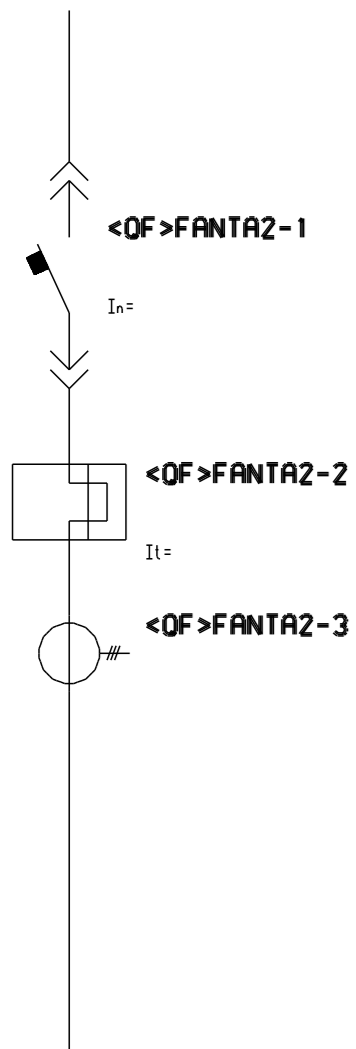

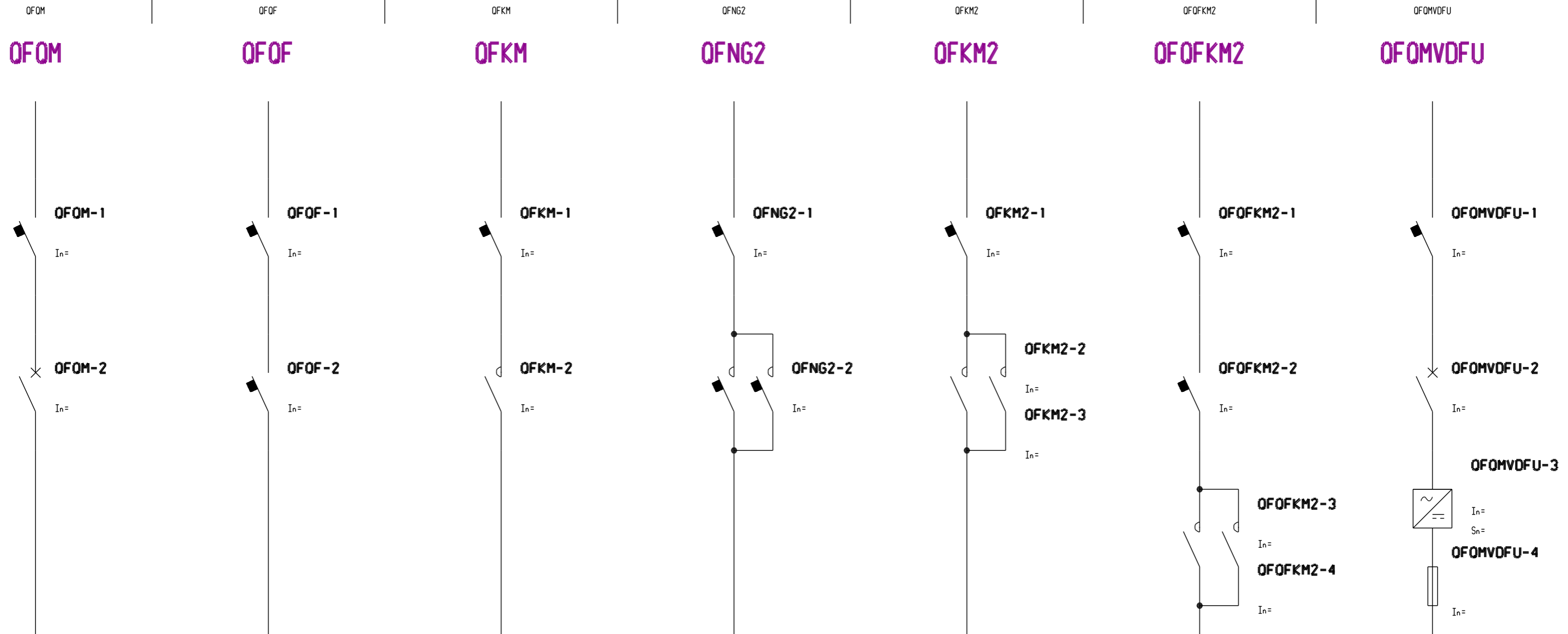

PRTA1<QF>\FU

PRTA1<QF>\FU2

PRTA1TA<QF>TA1\

PRTA<QF>TA1TA1\

PRTA1<QF>\FUTA2

PRTA1<QF>\FUTA1

PR<QF>\FUFU

PRTA1<QF>\FU PRTA1<QF>\FU2 PRTA1TA<QF>TA1\FU2 PRTA<QF>TA1TA1\FU2 PRTA1<QF>\FUTA2\FU PRTA1<QF>\FUTA1\FU PR<QF>\FUFU

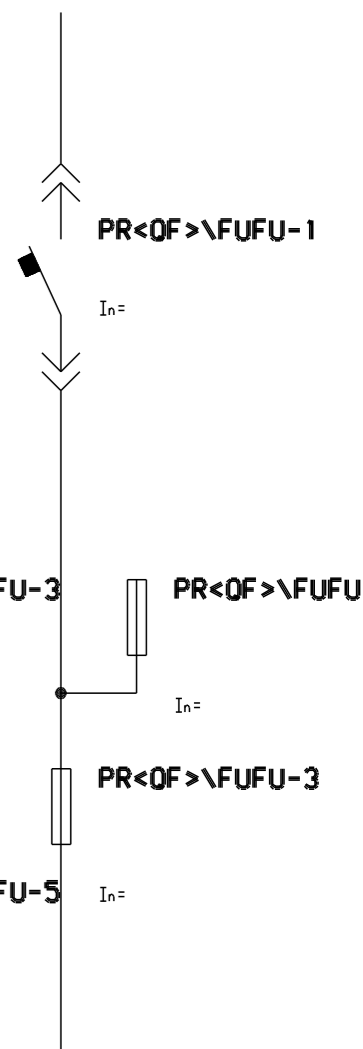
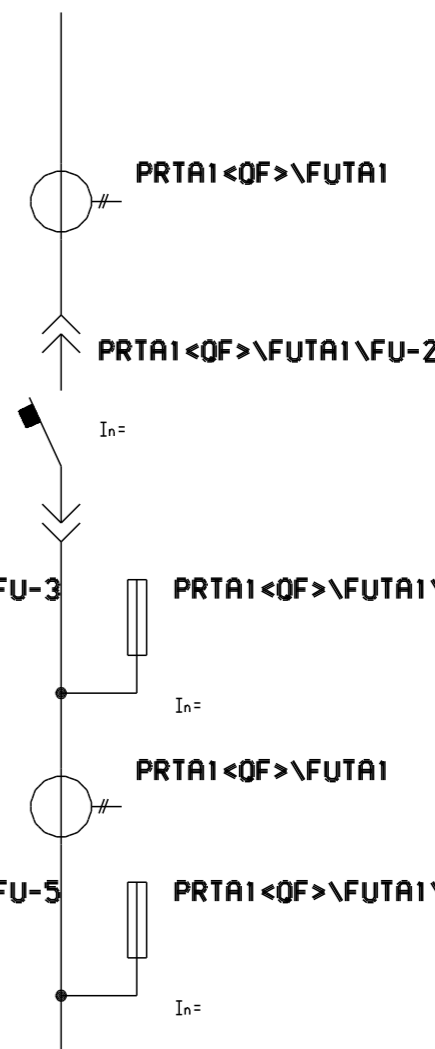
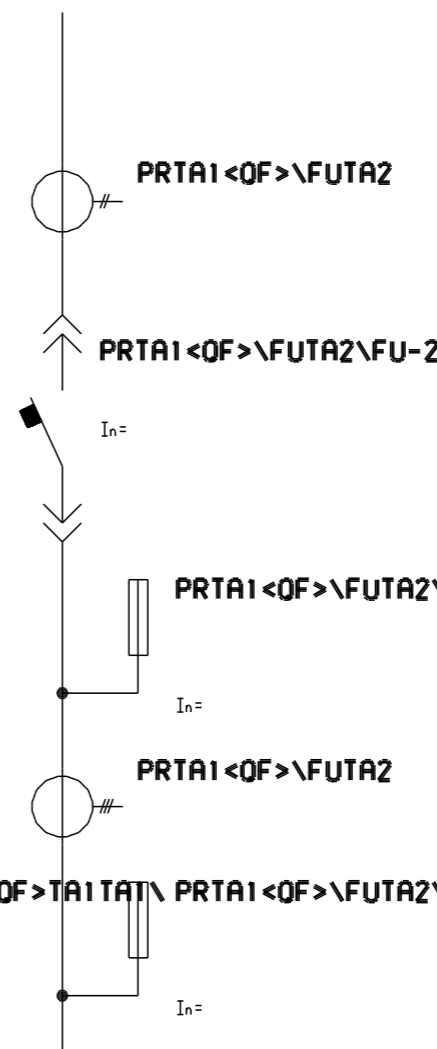
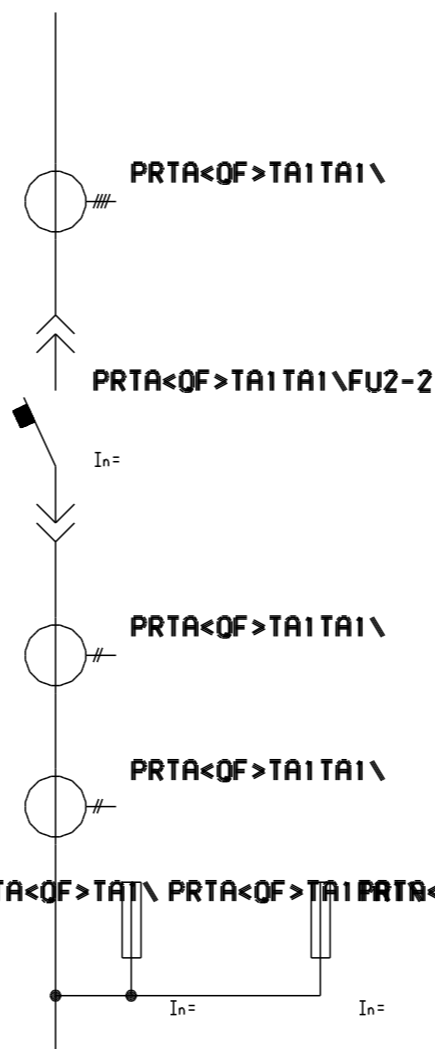
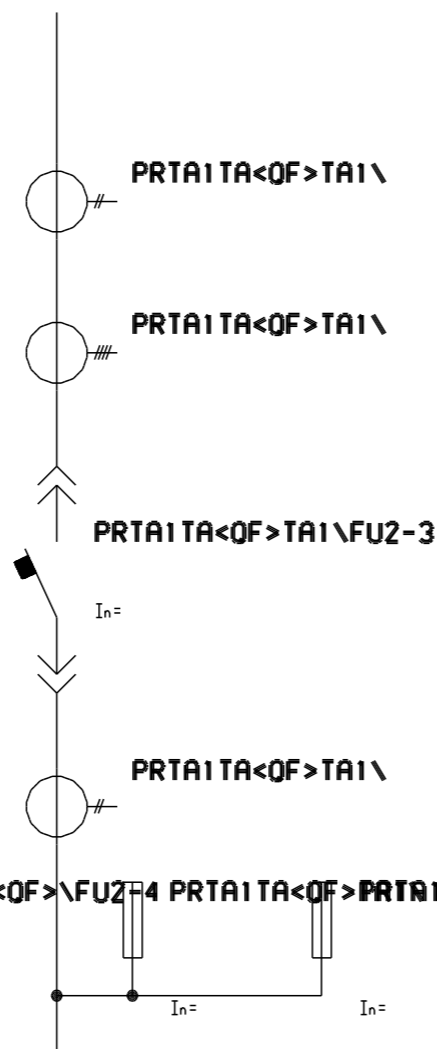
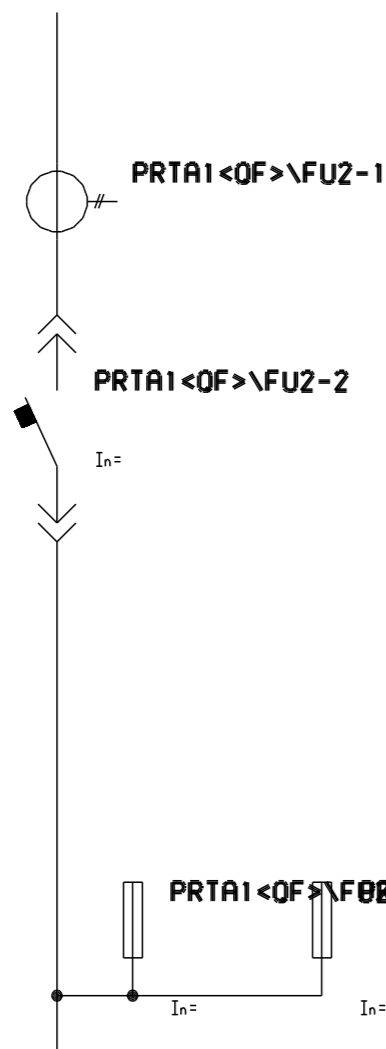
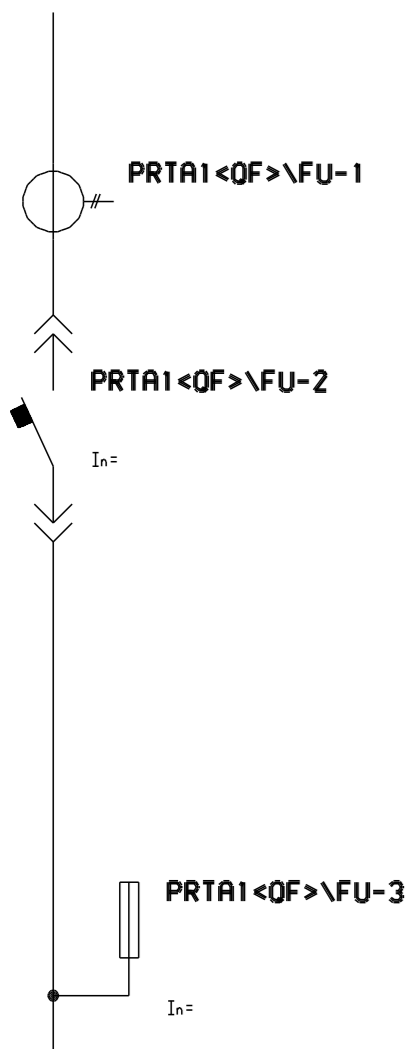

PRTATA1<QF>\FU2

PRTAQFTA1

PRTA1<QF>

PRTA1<QF>\FUTA\

PRTA1<QF>TA\FU2

PRTAQFTA1\FU2

PRTATA1<QF>\FU2

PRTAQFTA1

PRTA1<QF>

PRTA1<QF>\FUTA\FUITA1

PRTA1<QF>TA\FU2

PRTAQFTA1\FU2

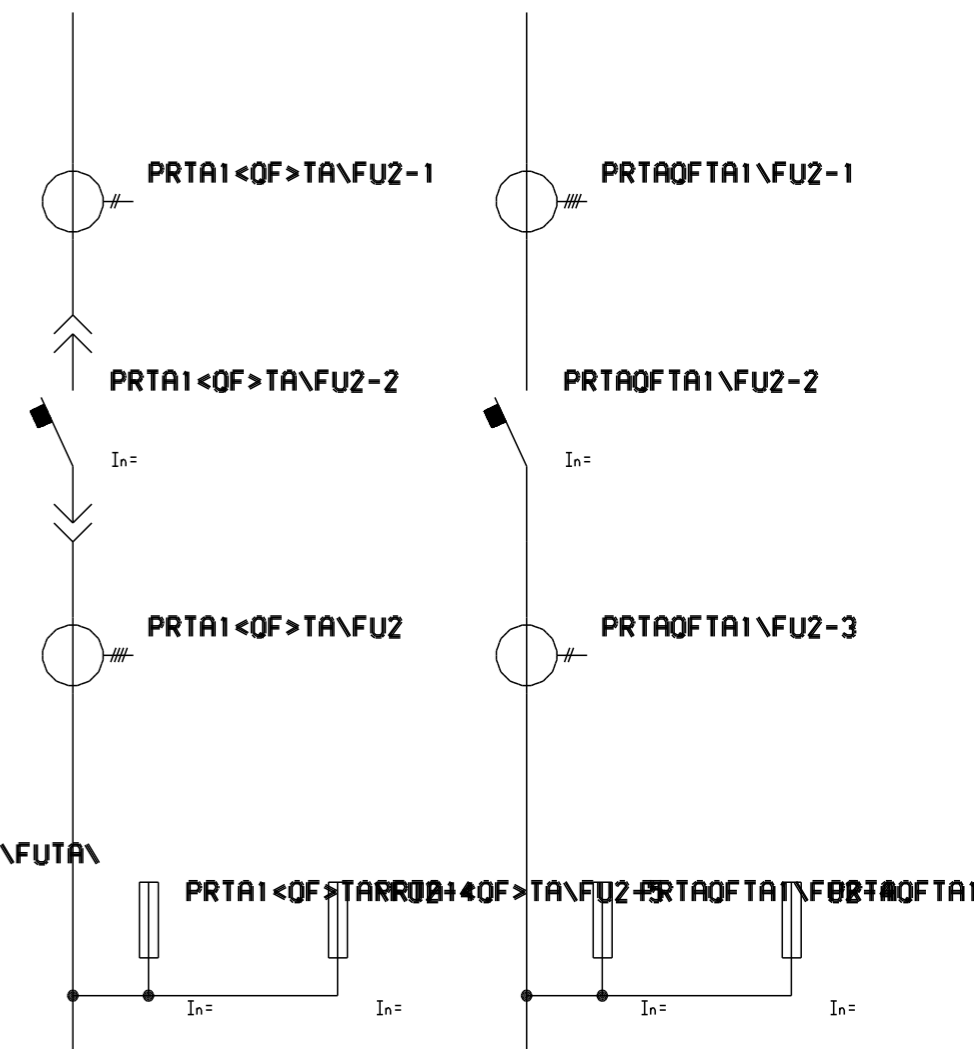
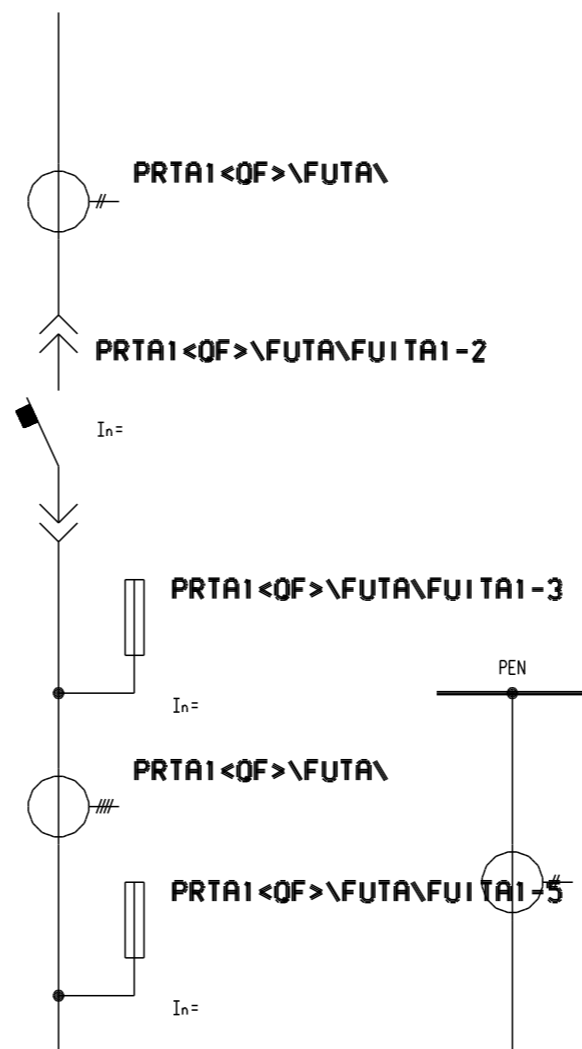
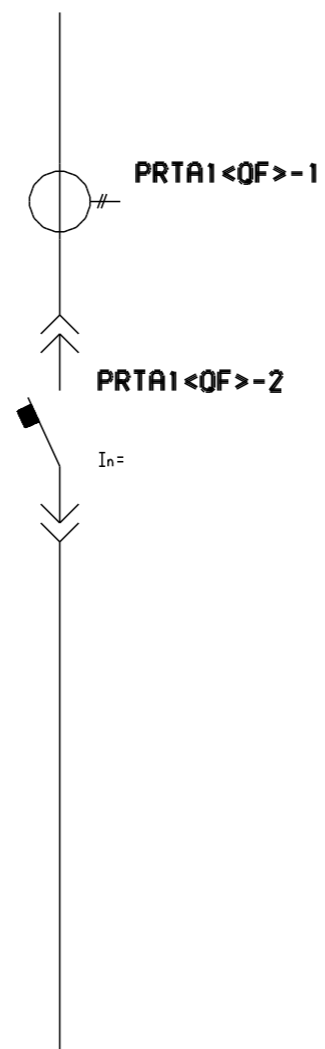
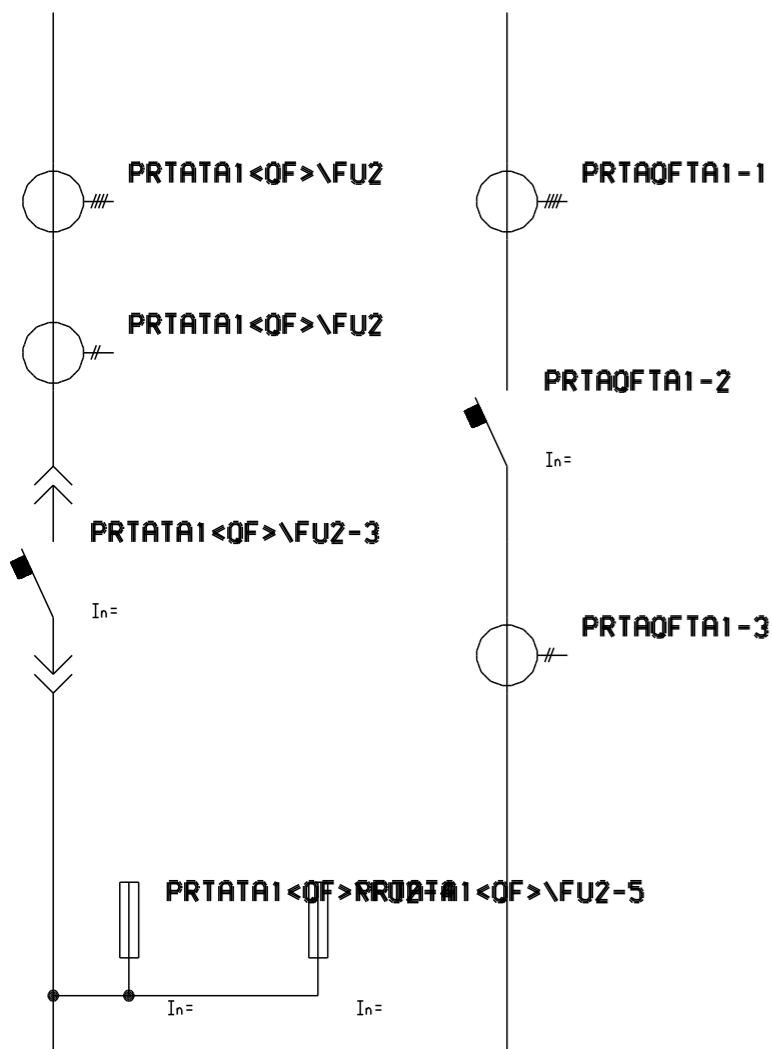

PRTA1<QF>\FUTA\FUITA1 - 2 MODULY

PRTA<QF>TA1TA1\

PRTA1<QF>TA\FUI

TA1QFTA1TA

TA1QF

TA1<QF>\FU

TA1<QF>\FUS

PRTA<QF>TA1TA1\FU PRTA1<QF>TA\FUITA1

TA1QFTA1TA

TA1QF

TA1<QF>\FU

TA1<QF>\FUS

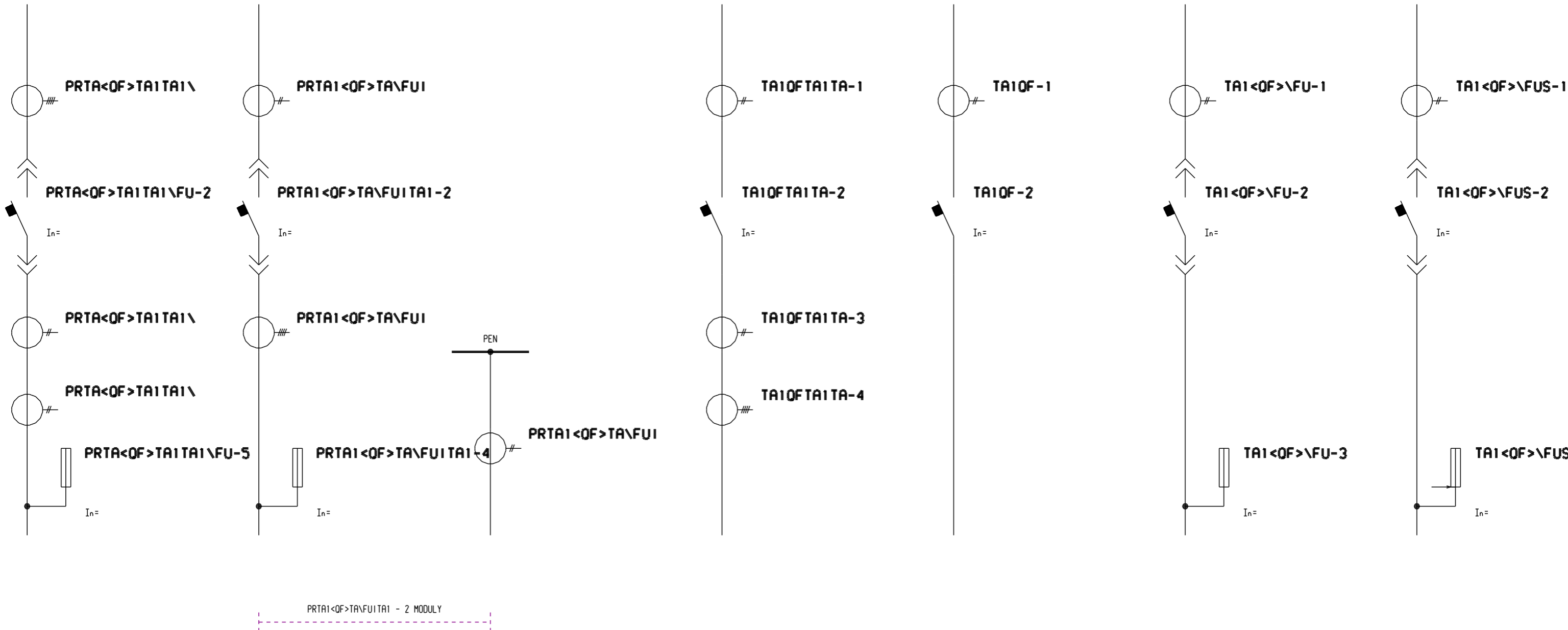

15.5.2000

16.5.2000

16.5.2000

16.5.2000

PR\FUTA1<QF>

<QF>IPE

PR<QF>TA1\FU\FU

PRTA<QF>\FU

PR<QF>TA1\FU

<QF>TA\FU2

PR\FUTA1<QF>

<QF>IPE

PR<QF>TA1\FU\FU2

PRTA<QF>\FU

PR<QF>TA1\FU

<QF>TA\FU2

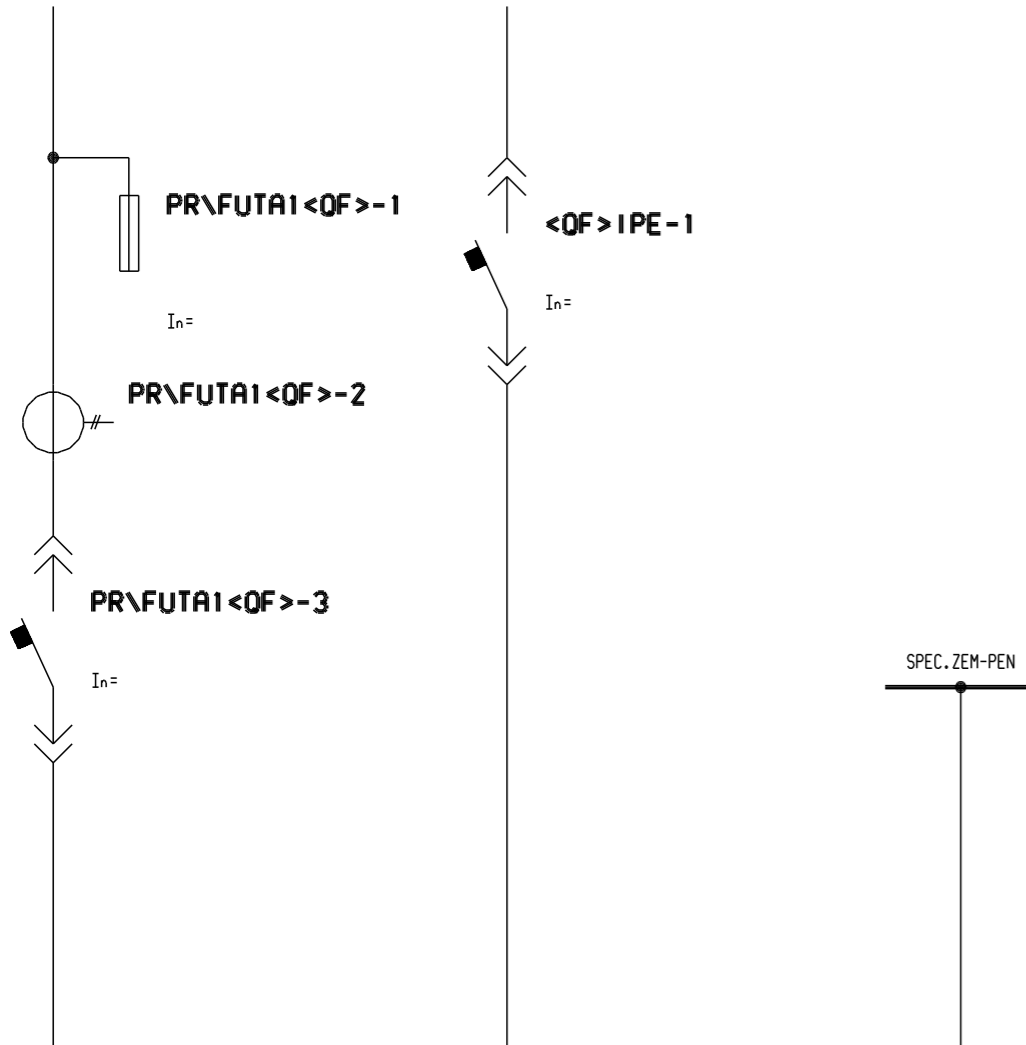

<QF>IPE - 2 MODULY

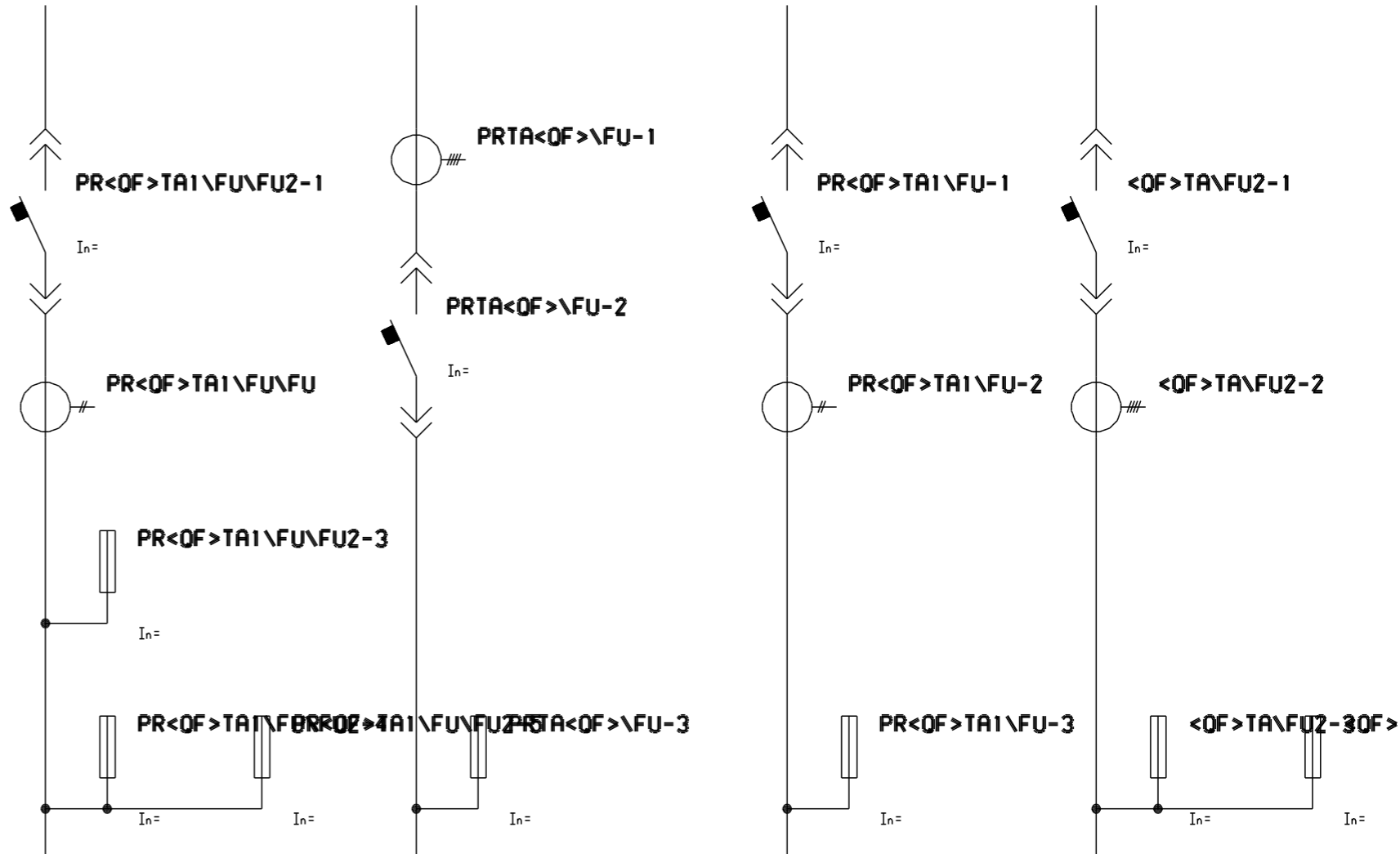

26.5.2000

26.5.2000

26.5.2000

26.5.2000

30.5.2000

TA1<QF>

TA1<QF>FAN

QFPA

PRPAQF

PRTA1<QF>\FUS

PRTA1<QF>TA1\FU

PR<QF>

TA1<QF>

TA1<QF>FAN

QFPA

PRPAQF

PRTA1<QF>\FUS

PRTA1<QF>TA1\FUS

PR<QF>

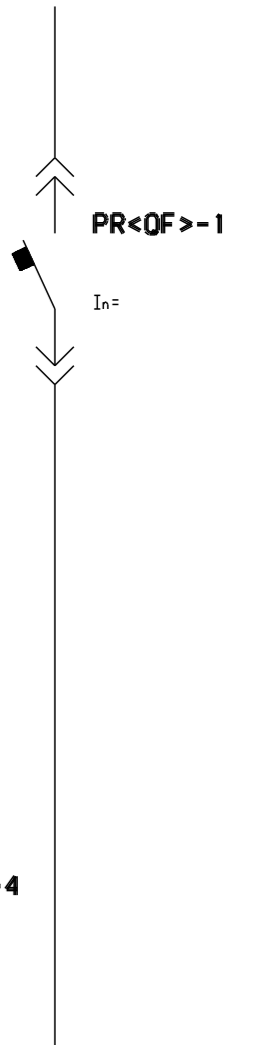
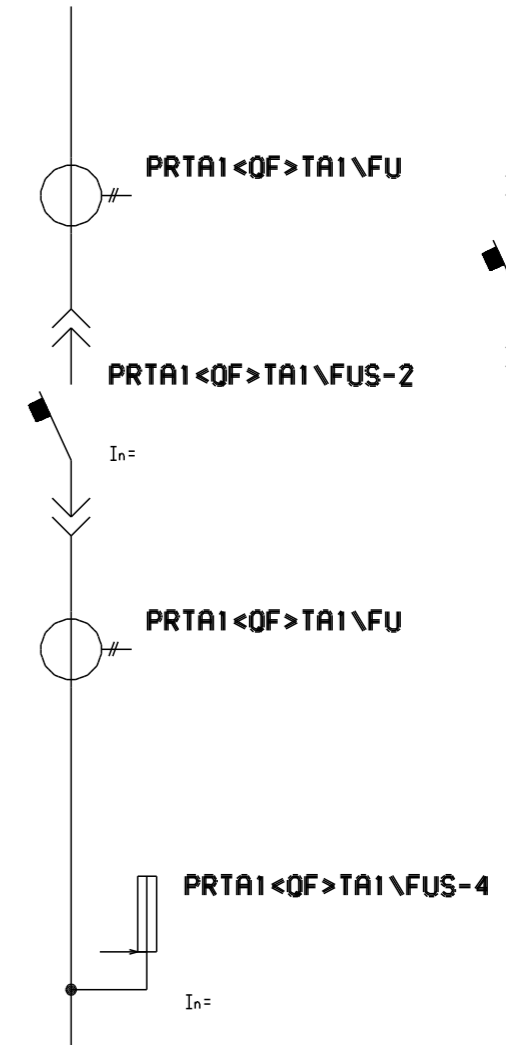
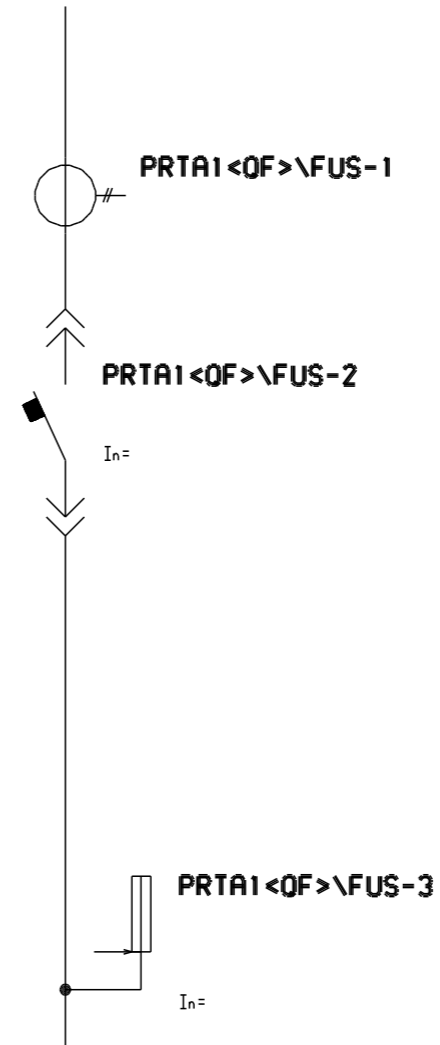
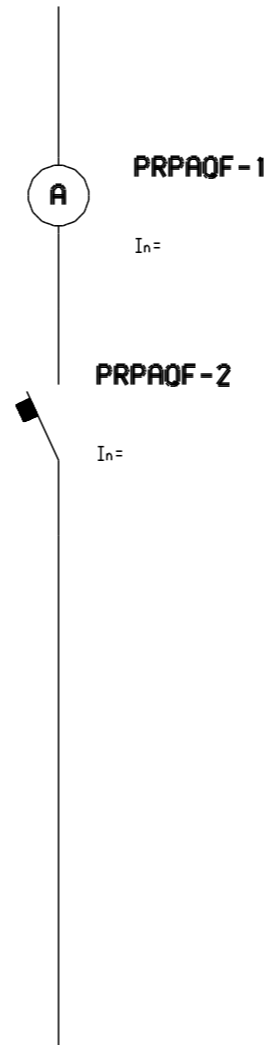
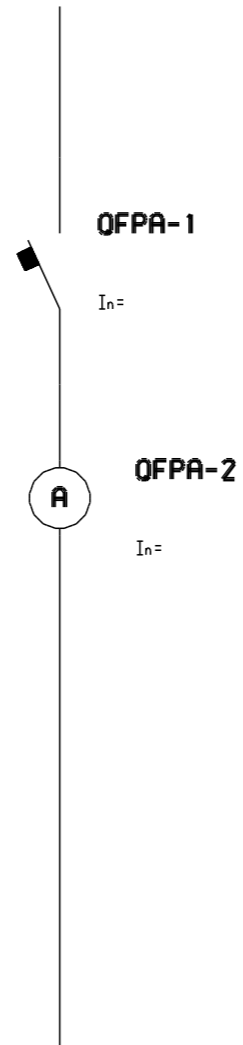
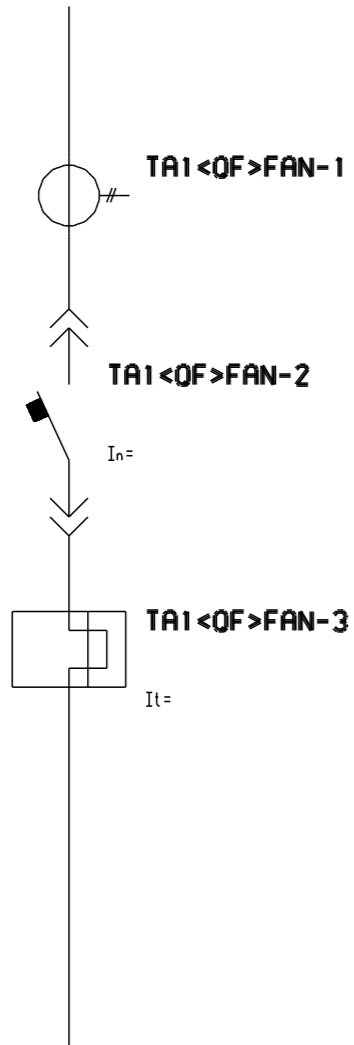
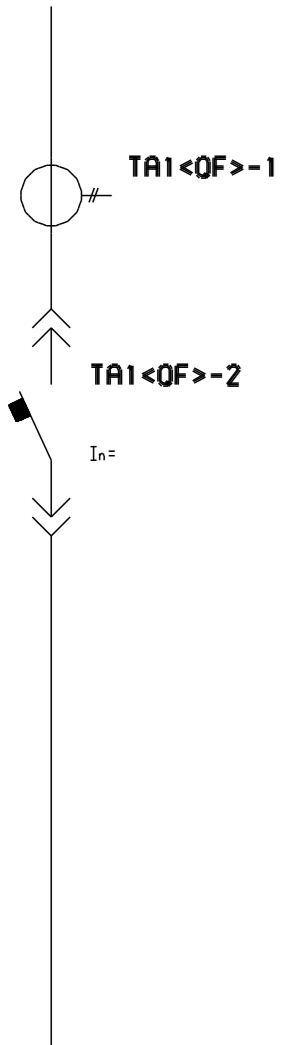

DOPLNEK 30.5.2000
 DOPLNEK 26.5.2000
 ZALOZEN 17.5.2000
 ARCH.CISLO 4700-X-000100

PRILOHA 2.1. TYPY ODBOCEK
ODBOCKY ZACINAJICI JISTICEM-8

5.6.2000

5.6.2000

9.6.2000

16.6.2000

OFF

PRTA1<QF>\FU\FU

PAQF

PR<QF>TA1\FUS2

PRTA1QF\FUFU

QFRP

PR\FUSTA1<QF>\F

OFF

PRTA1<QF>\FU\FUS

PAQF

PR<QF>TA1\FUS2

PRTA1QF\FUFU

QFRP

PR\FUSTA1<QF>\FU2

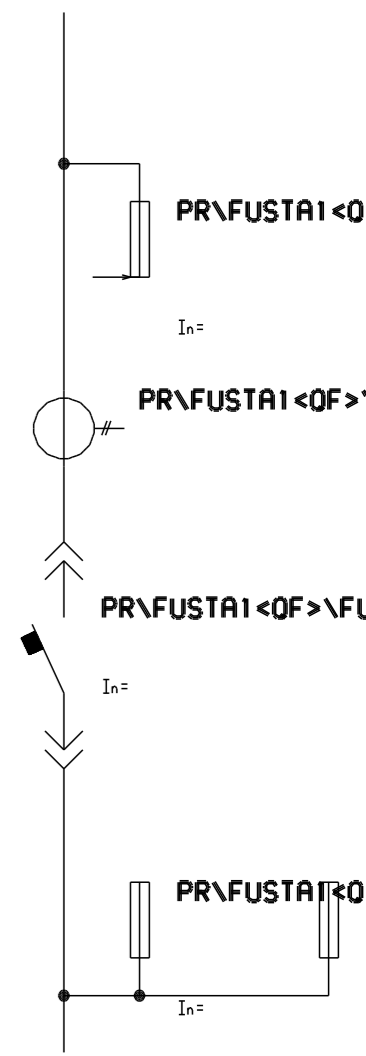
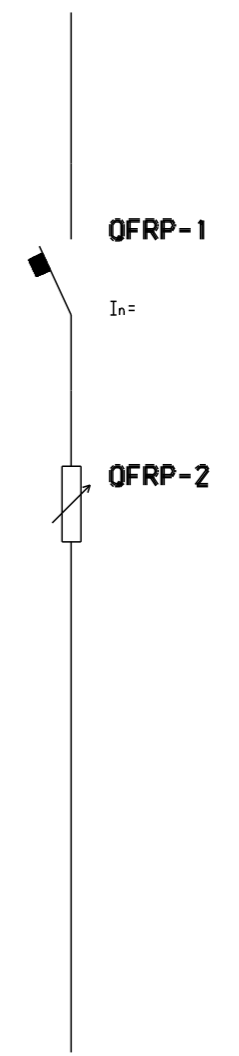
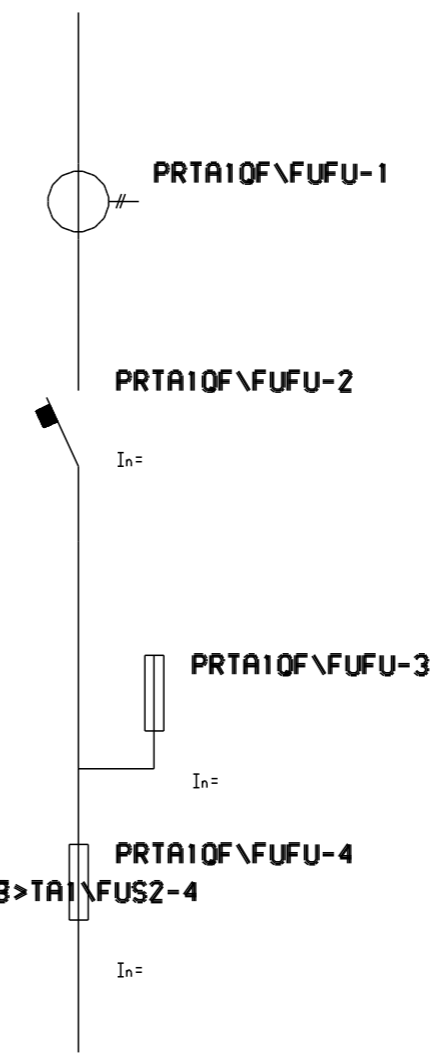
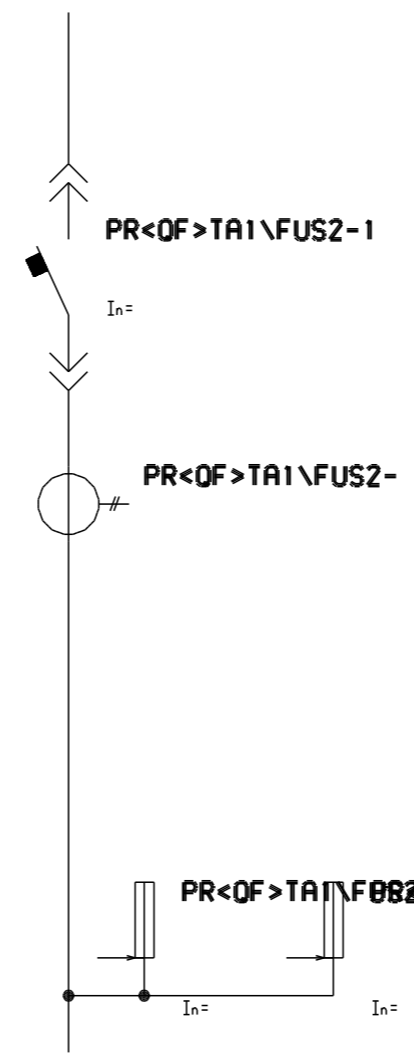
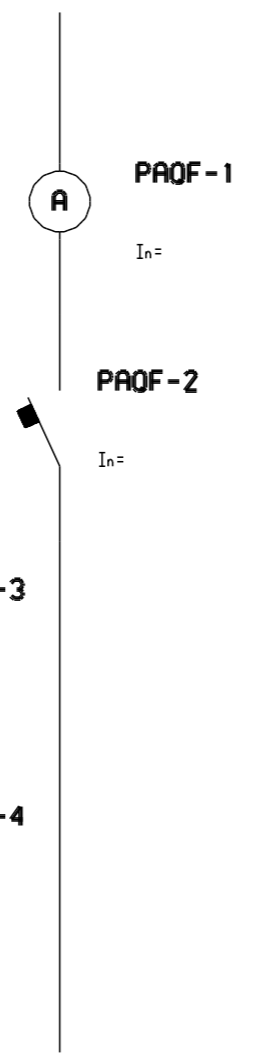
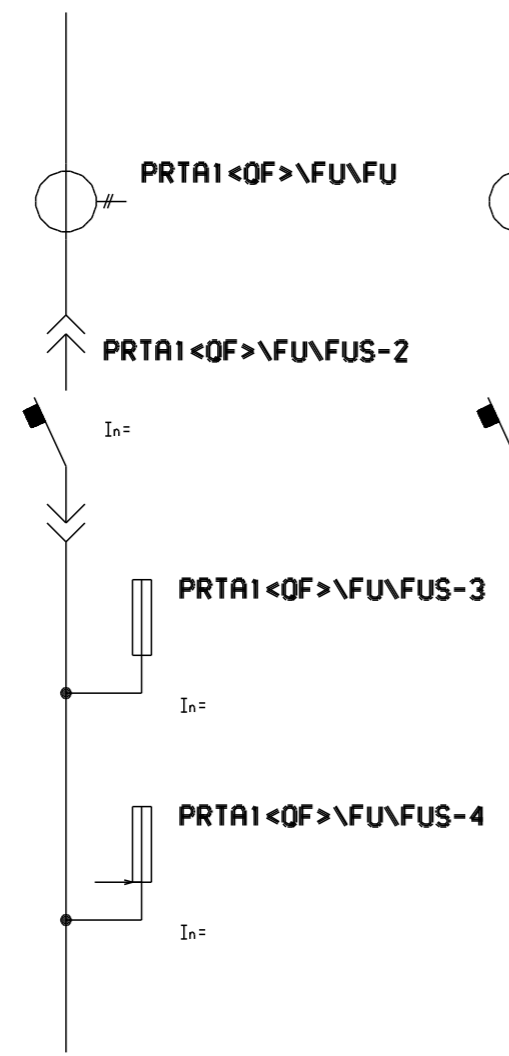
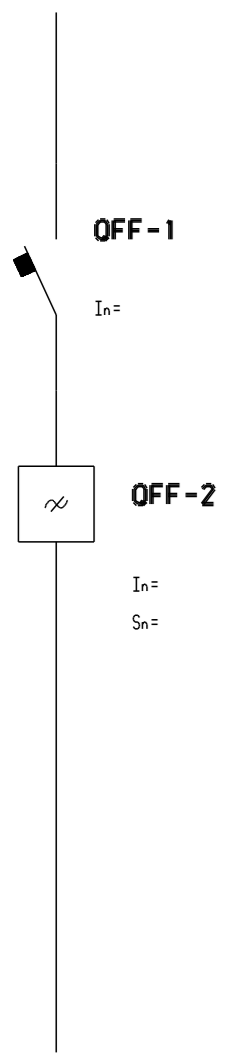

DOPLNEK 16.6.2000
DOPLNEK 9.6.2000
DOPLNEK 5.6.2000
ZALOZEN 1.6.2000
ARCH.CISLO 4700-X-000100

**PRILOHA 2.1. TYPY ODBOCEK
ODBOCKY ZACINAJICI JISTICEM-9**

PR\FUSTA1<QF>

PR<QF>TA1\FUS

<QF>RA

PRTA1QF\QF

QFZ

QFNG

PROF\QF

PR\FUSTA1<QF>

PR<QF>TA1\FUS

<QF>RA

PRTA1QF\QF

QFZ

QFNG

PROF\QF

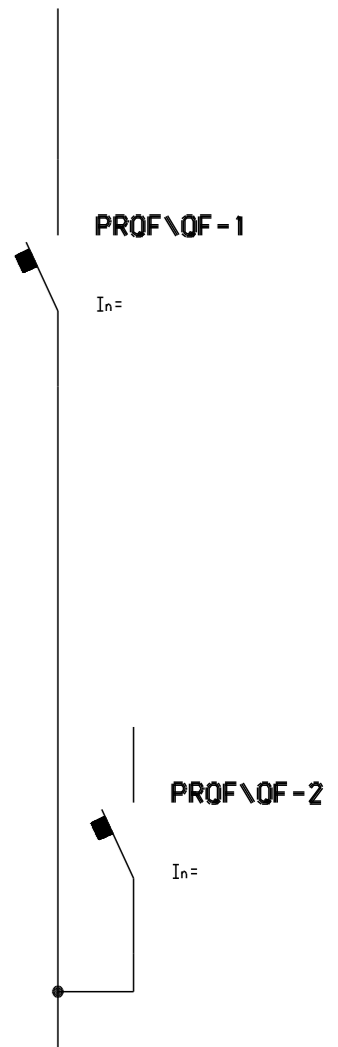
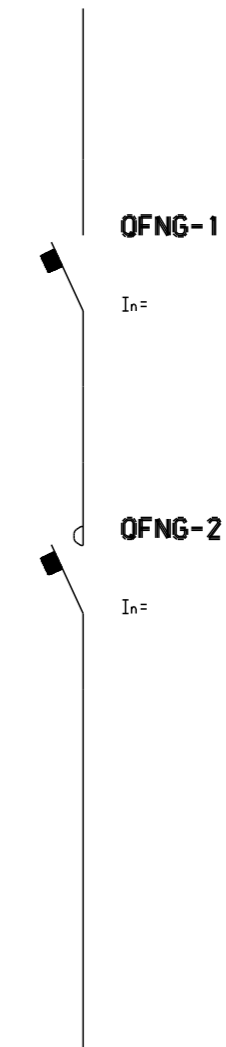
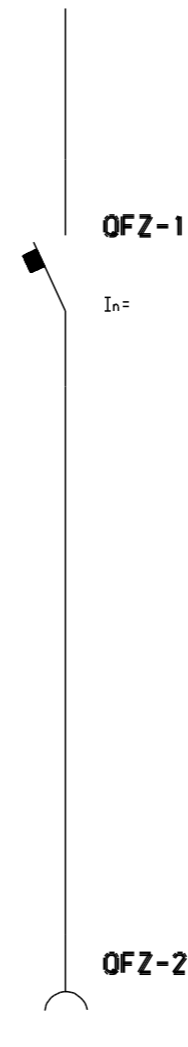
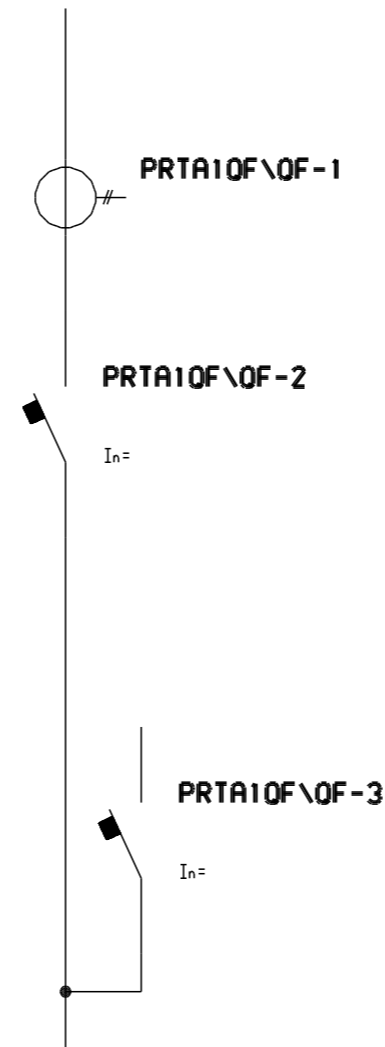
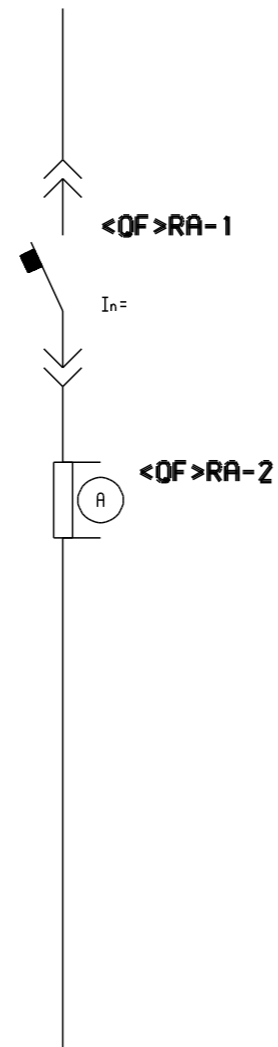
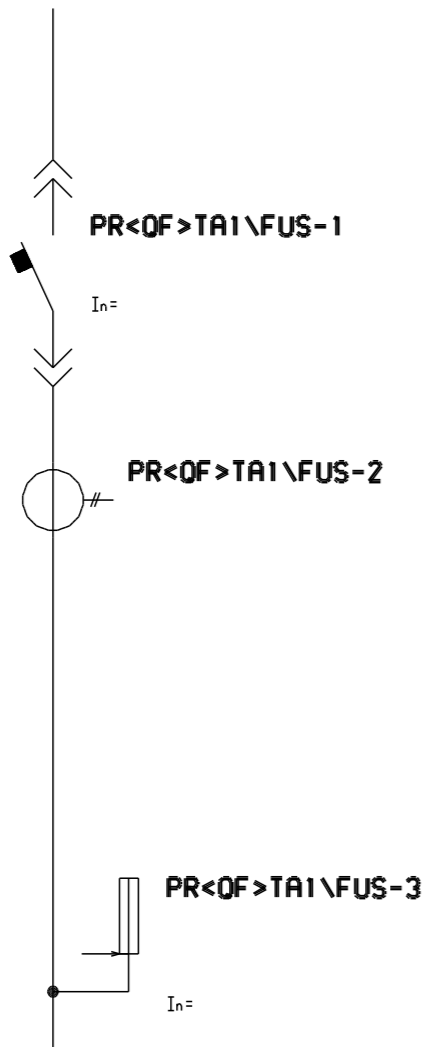
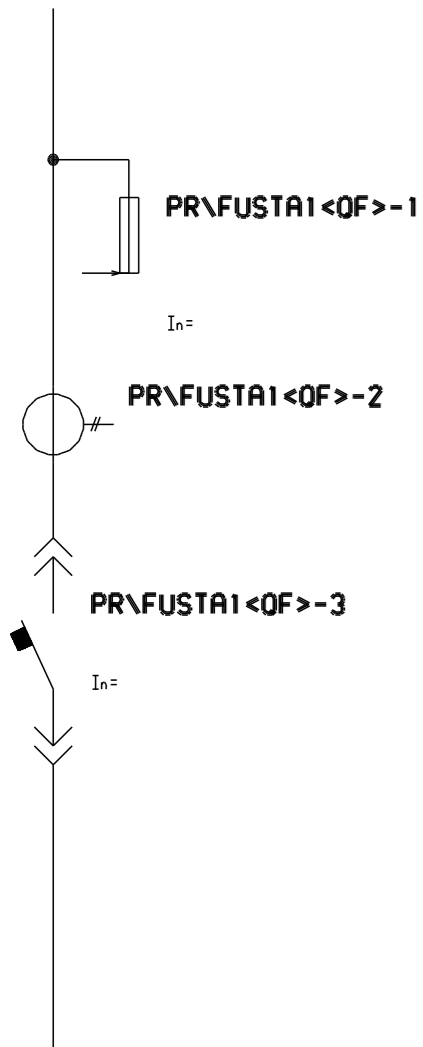

PRTAQF\OFFU

OFFI

PRTAQF\OF

PRTATA1<OF>\FUS

PRTAITA<OF>\FUS

PROFD

<OF>TA1\FUS

PRTAQF\OFFU

OFFI

PRTAQF\OF

PRTATA1<OF>\FUS2 PRTAITA<OF>\FUS2

PROFD

<OF>TA1\FUS

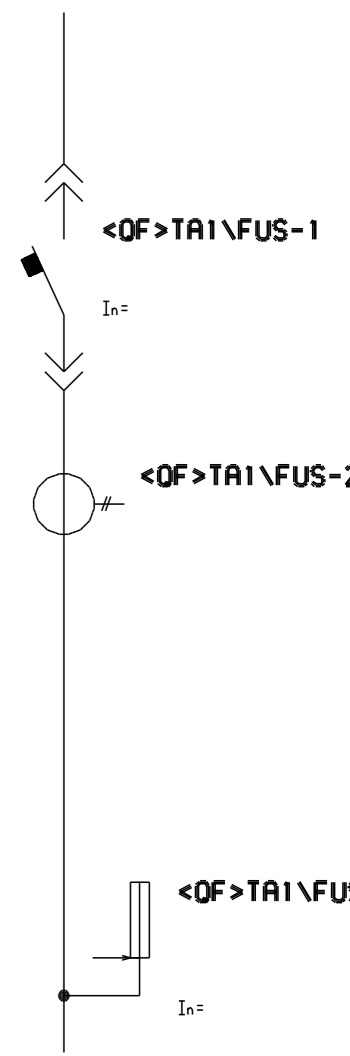
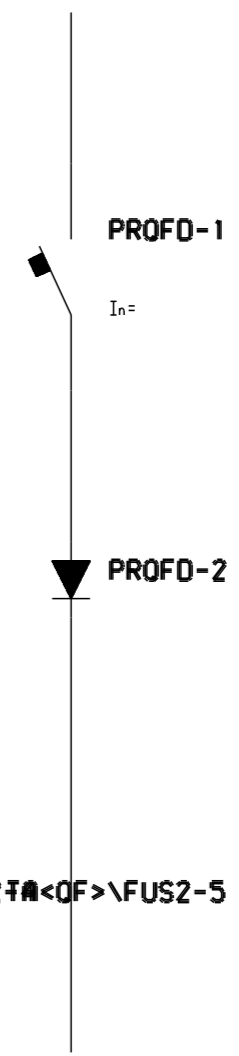
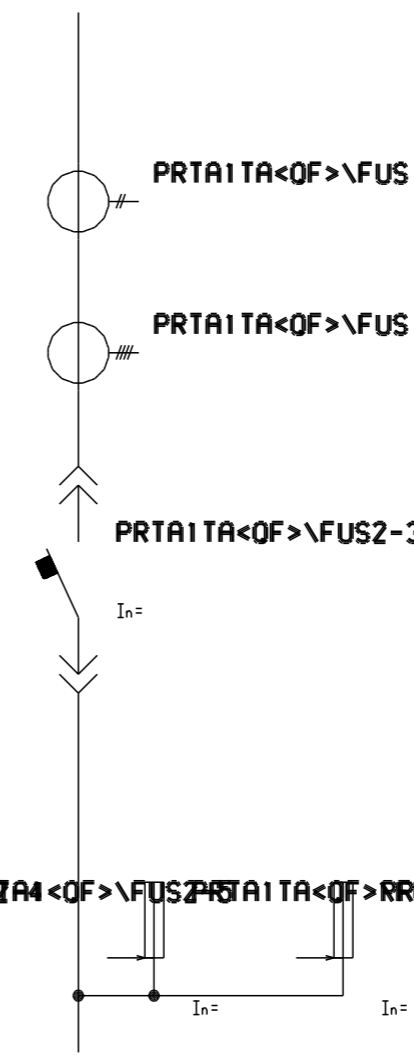
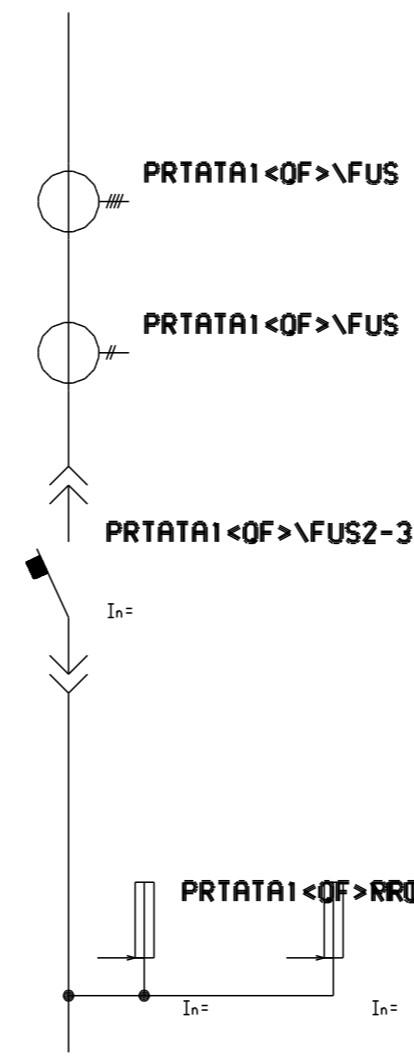
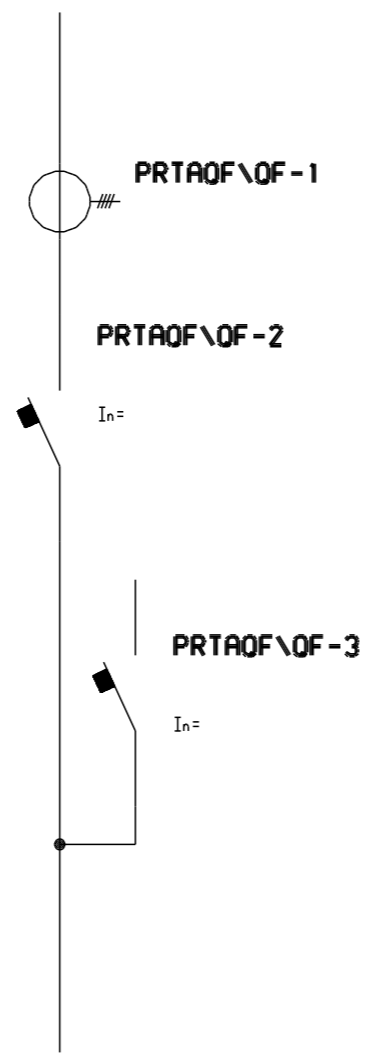
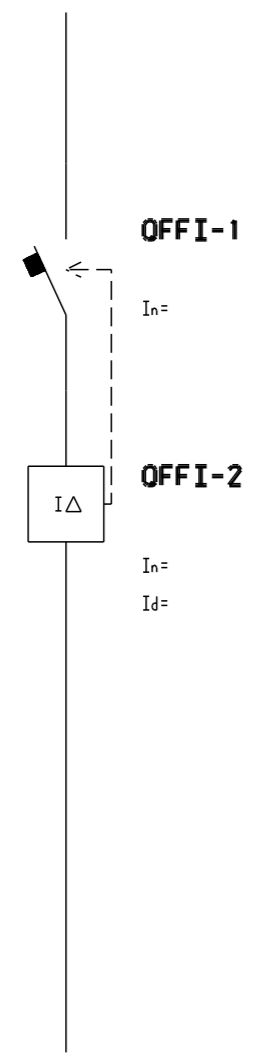
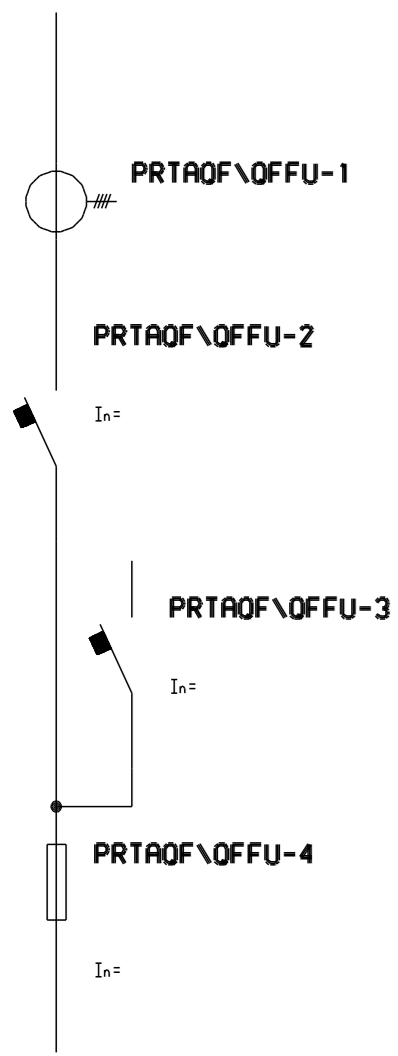

5.9.2000

8.9.2000

19.9.2000

19.9.2000

PR<QF>TANFU\FUS

<QF>TANFU\FUS

\FUSTA1<QF>

PRATA1QF\FU

PRATA1QF\FUS

<QF>FUS

<QF>TANFU\FUS IPE

<QF>TANFU\FUS

\FUSTA1<QF>

PRATA1QF\FU

PRATA1QF\FUS

<QF>FUS

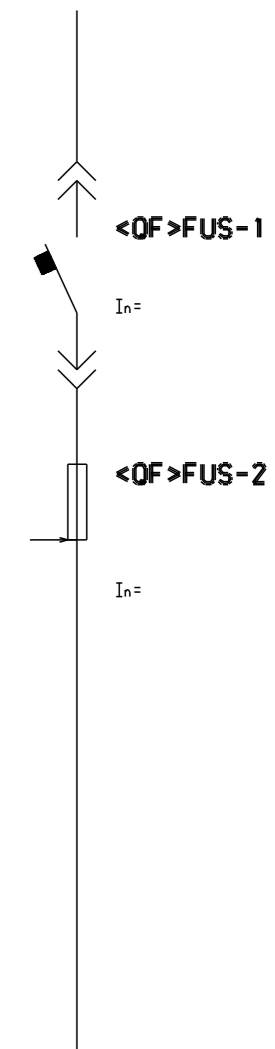
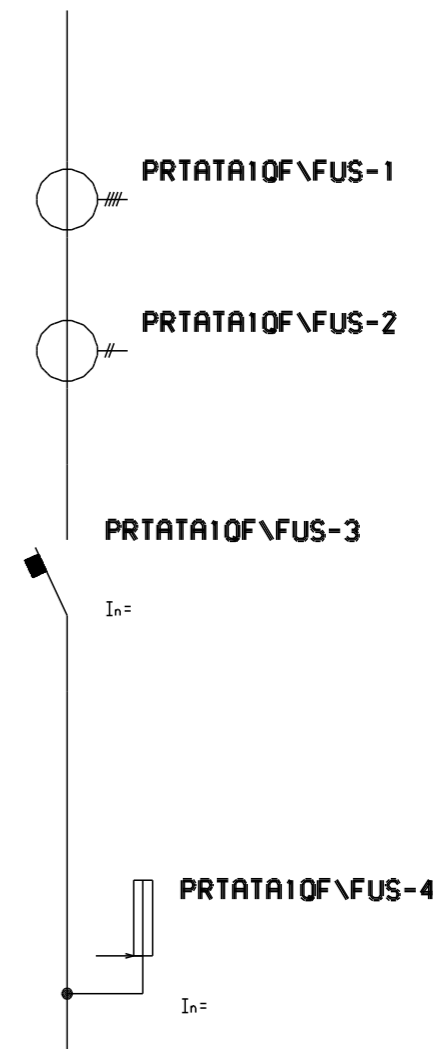
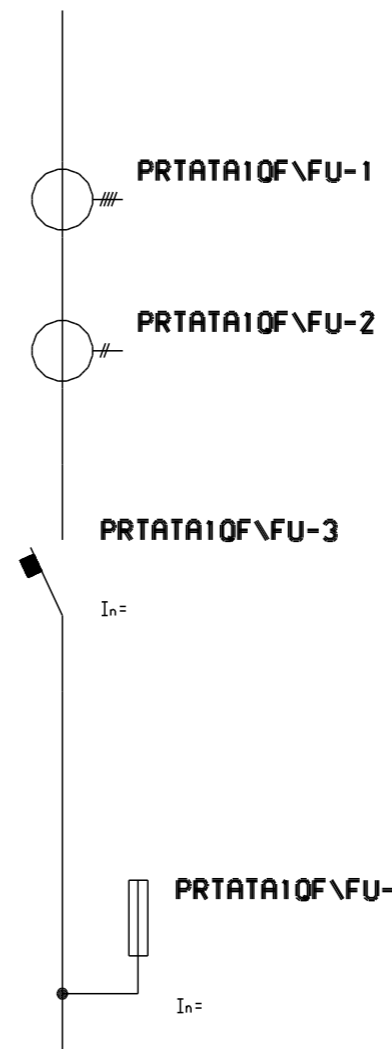
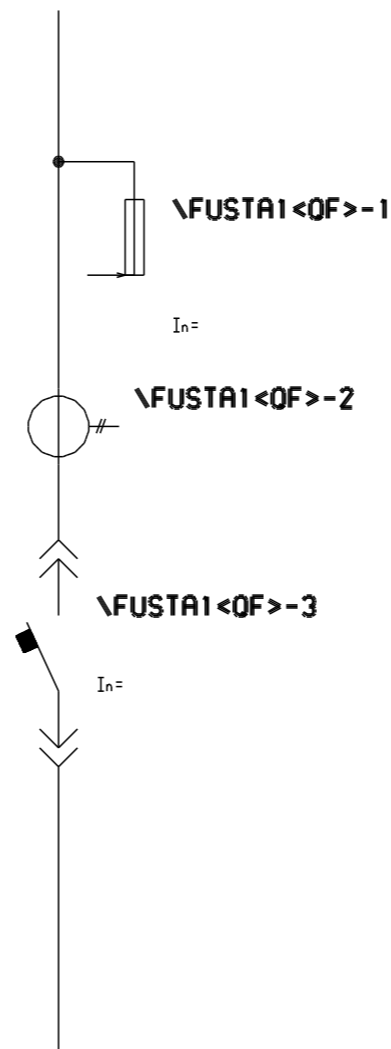
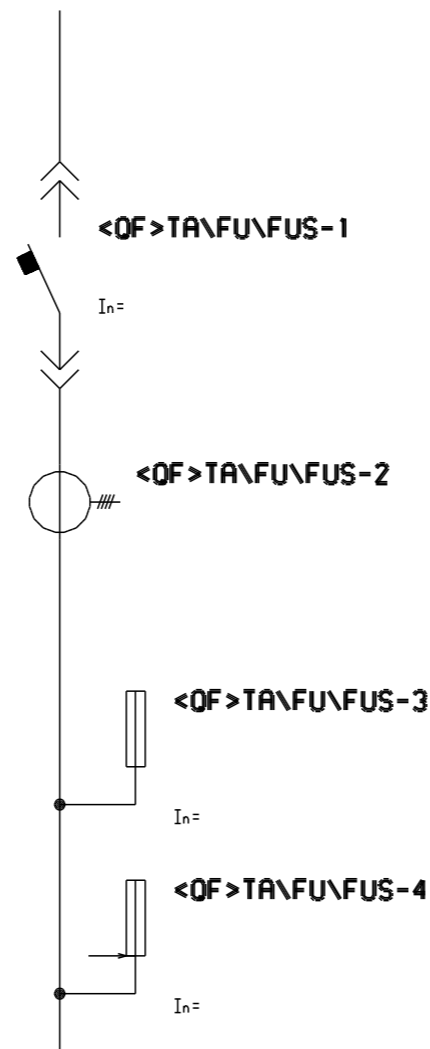
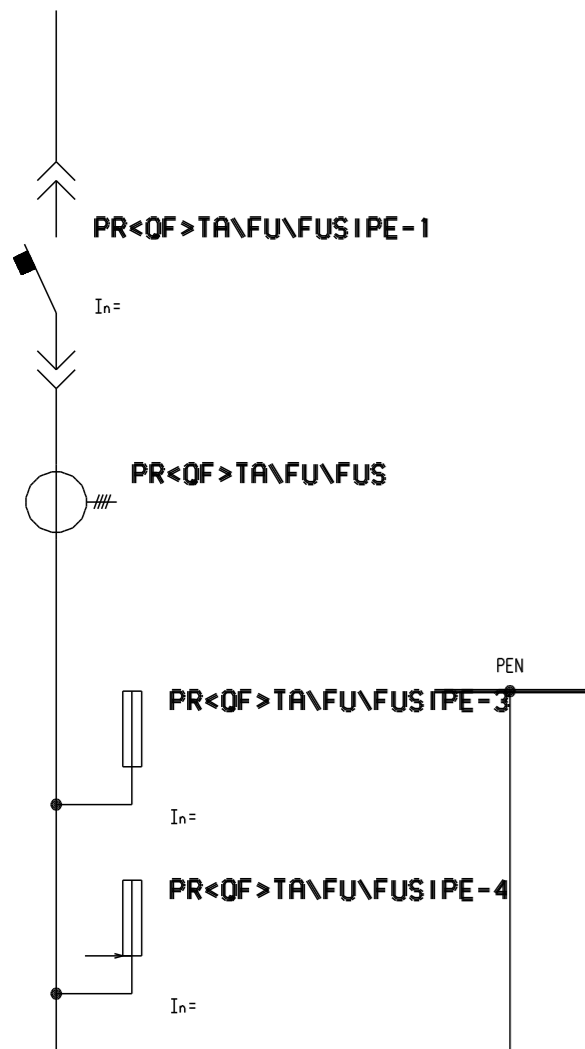

PR<QF>TANFU\FUS IPE - 2 MODULY

13.11.2000

13.11.2000

13.11.2000

PROF\FU2\FU

PROF

QFRA

PRTA1TA<QF>TA1\

PRTA1TAQF\FUS2

PRTA<QF>TA1\FUS

PROF\FU2\FU

PROF

QFRA

PRTA1TA<QF>TA1\FUS2 PRTA1TAQF\FUS2 PRTA<QF>TA1\FUSITAI

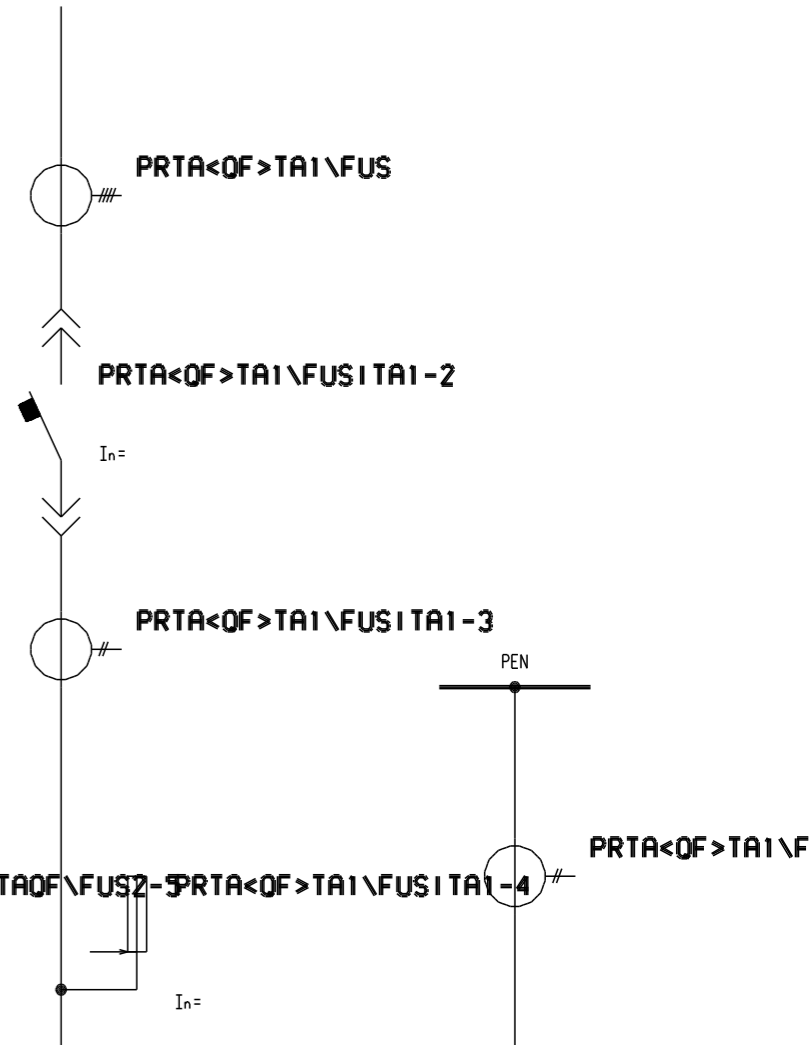
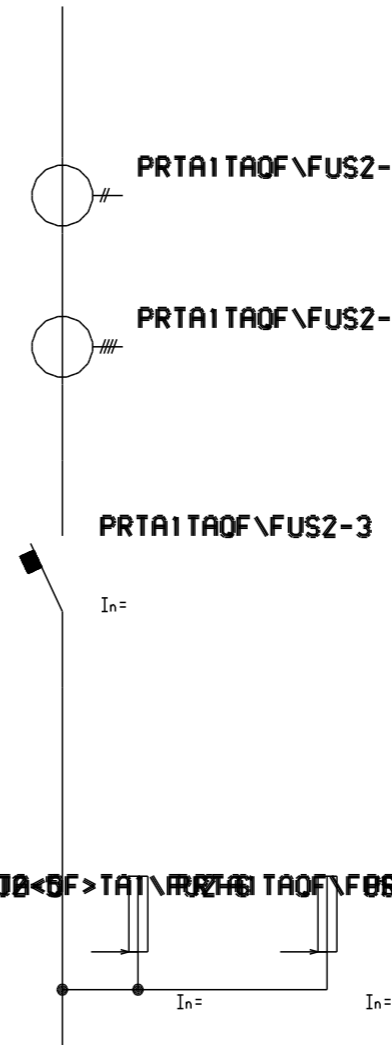
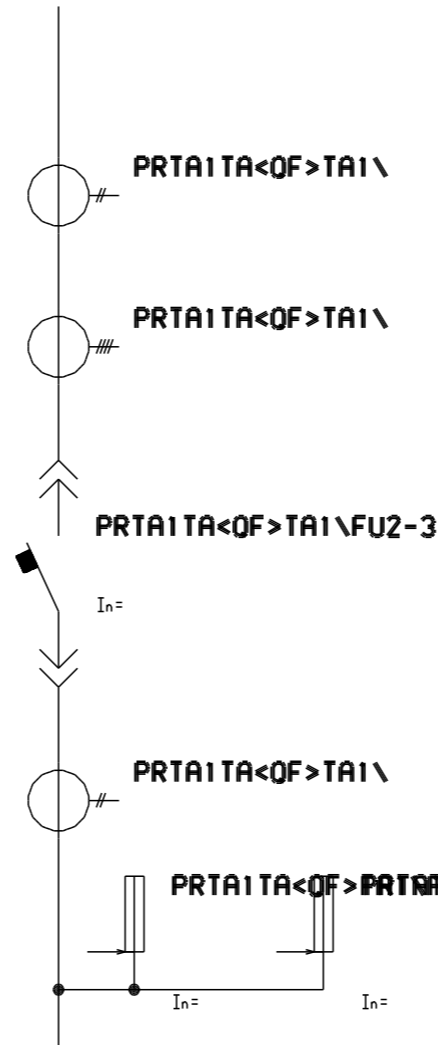
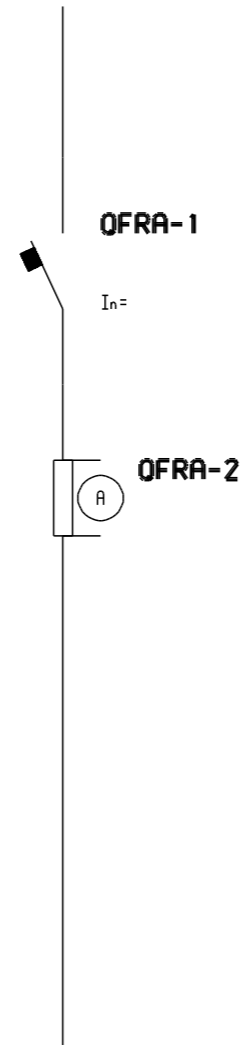
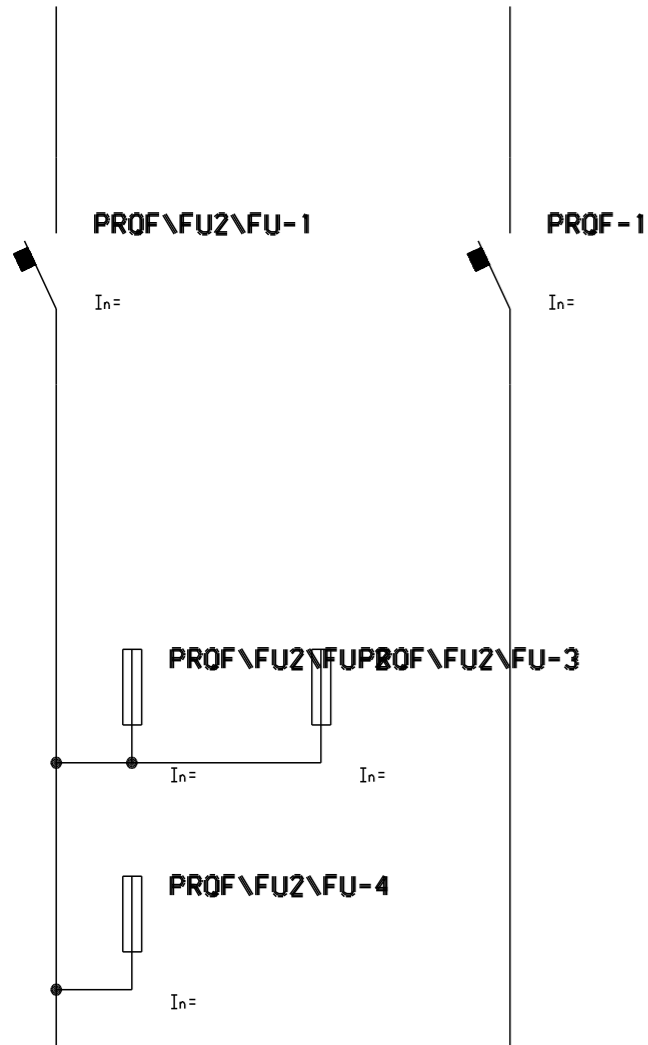

PRTA<QF>TA1\FUSITAI - 2 MODULY

14.11.2000

24.11.2000

24.11.2000

PRTA1TA<QF>TA1\

QFNGVD

PRTA1<QF>TA1\FU

PRTA1<QF>TA\FUS

<QF>X

PRTA1TA<QF>TA1\FUS

QFNGVD

PRTA1<QF>TA1\FUSITAI

PRTA1<QF>TA\FUSITAI

<QF>X

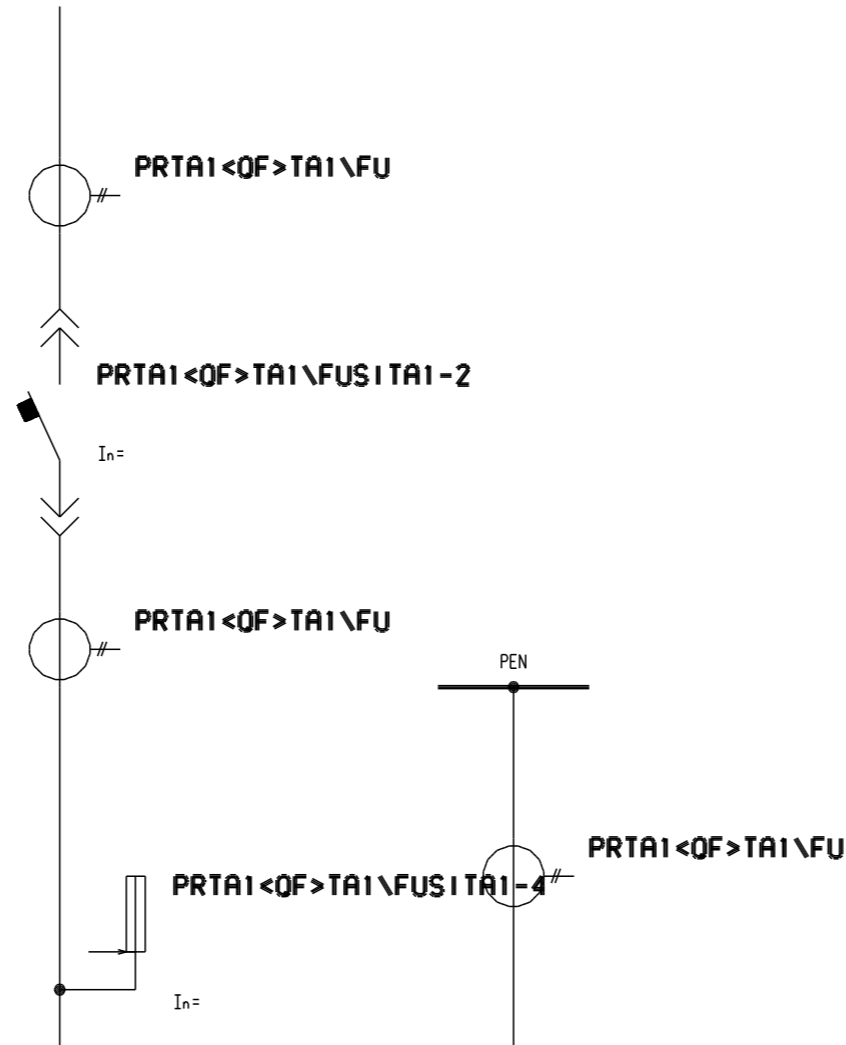
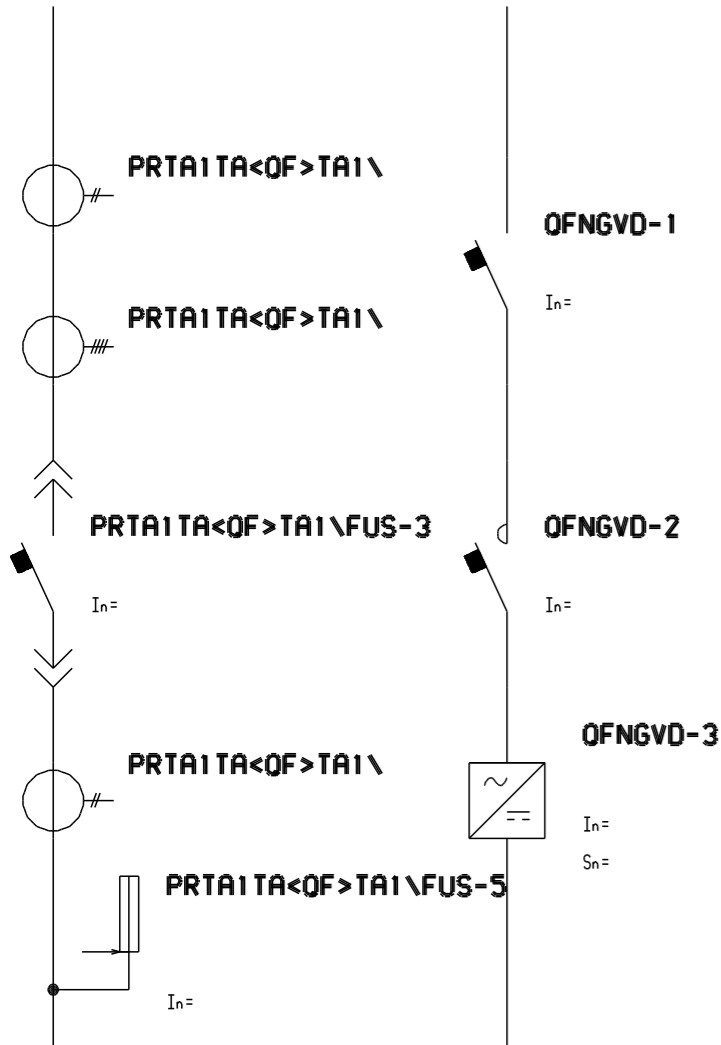

PRTA1<QF>TA1\FUSITAI - 2 MODULY

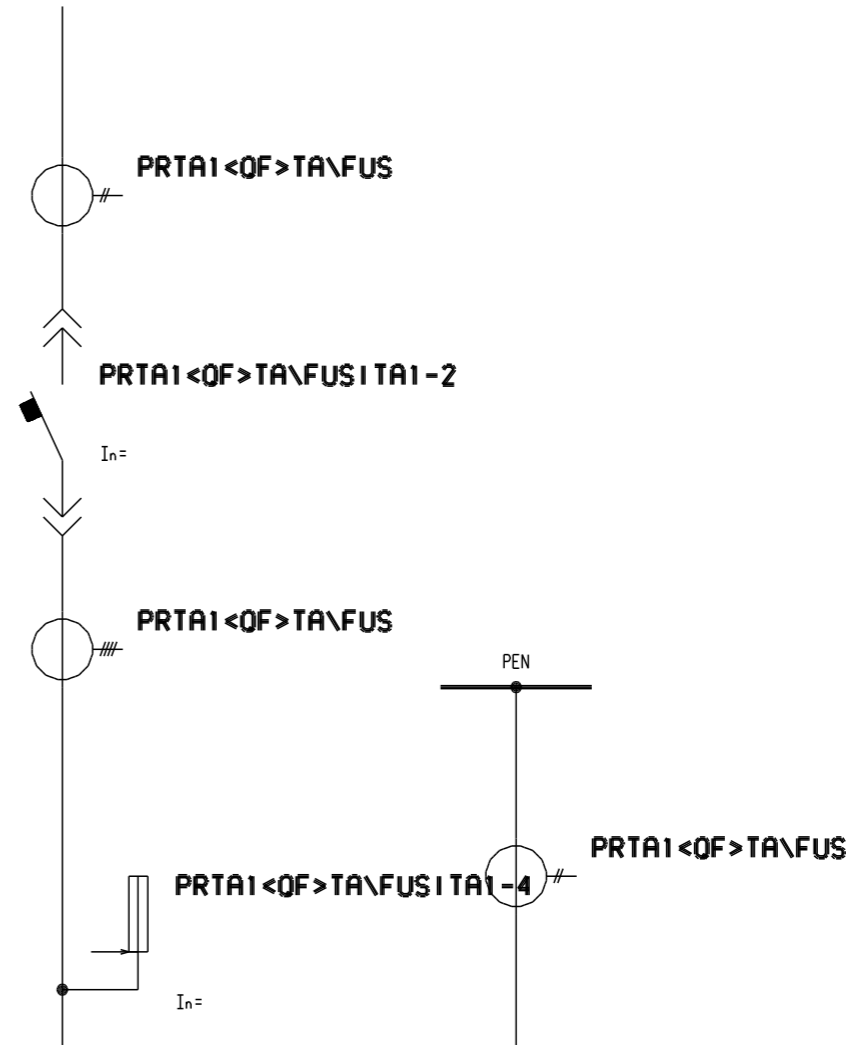

PRTA1<QF>TA\FUSITAI - 2 MODULY

<QF>KM
<QF>KM

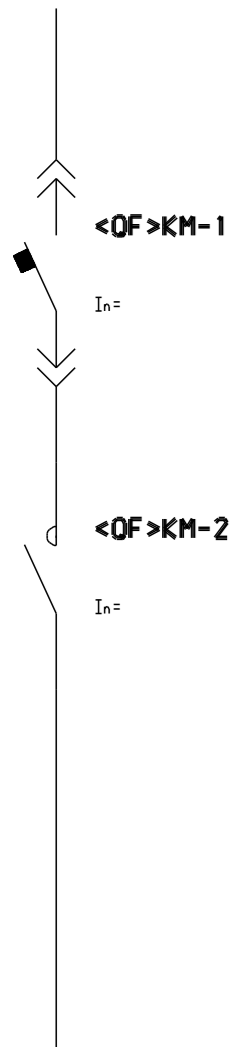

<QF>QF
<QF>QF

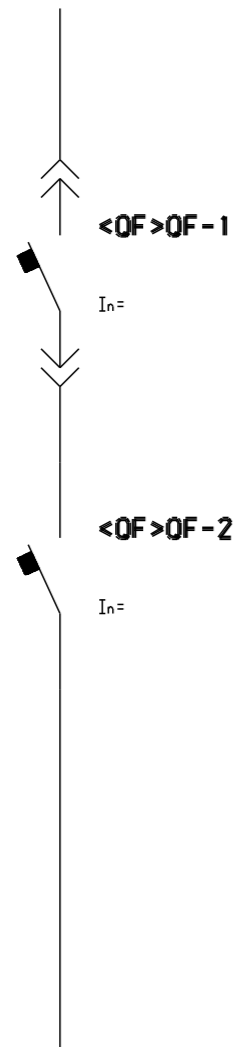

PRTA<QF>TA1\FUS
PRTA<QF>TA1\FUS I TA1

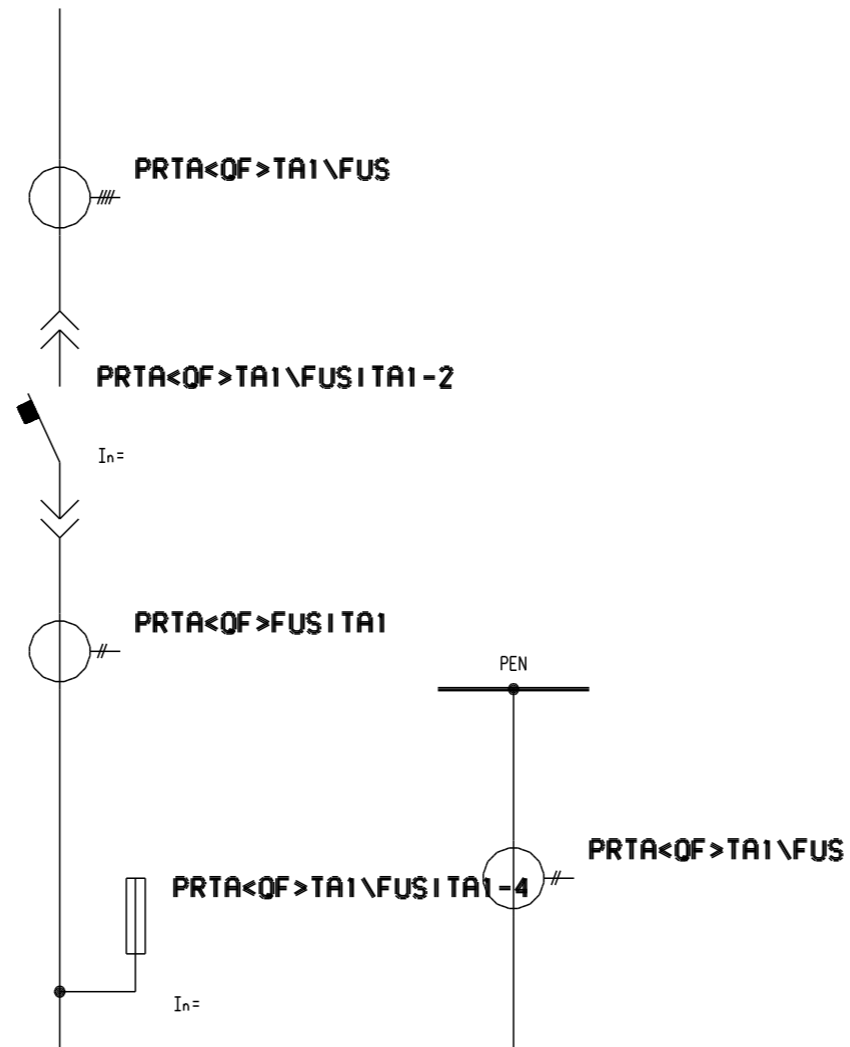

<QF>TA
<QF>TA

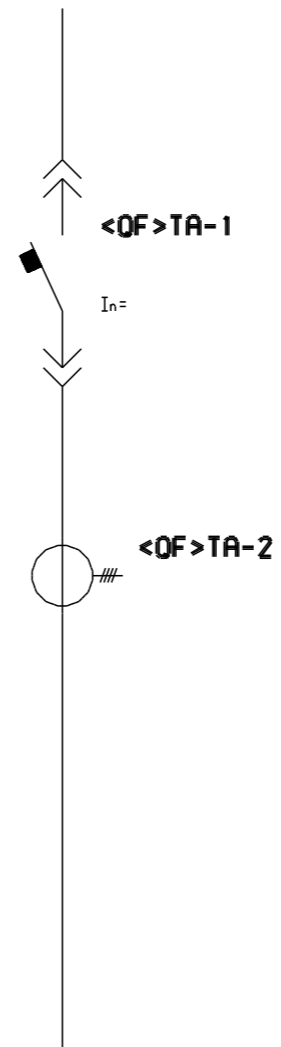

QF\OVLNG
QF\OVLNG

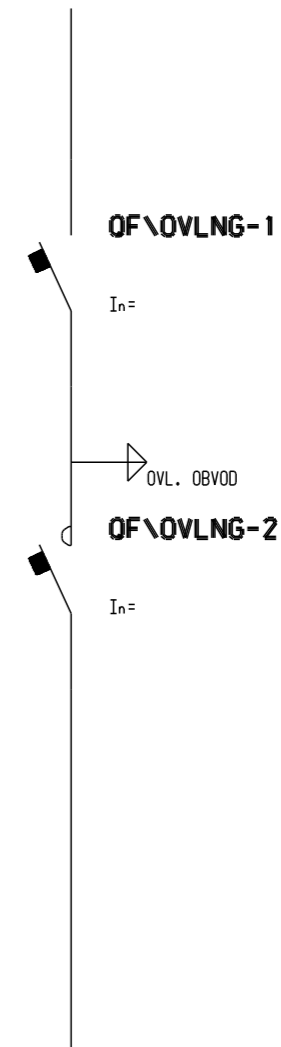

QFKM2TA1
QFKM2TA1

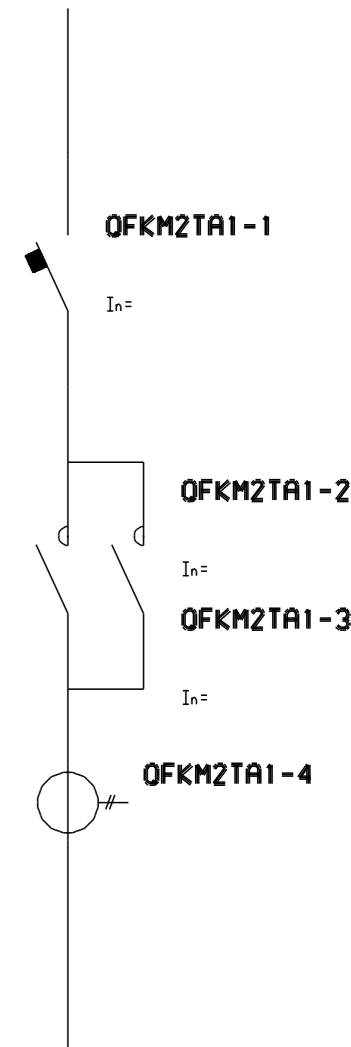

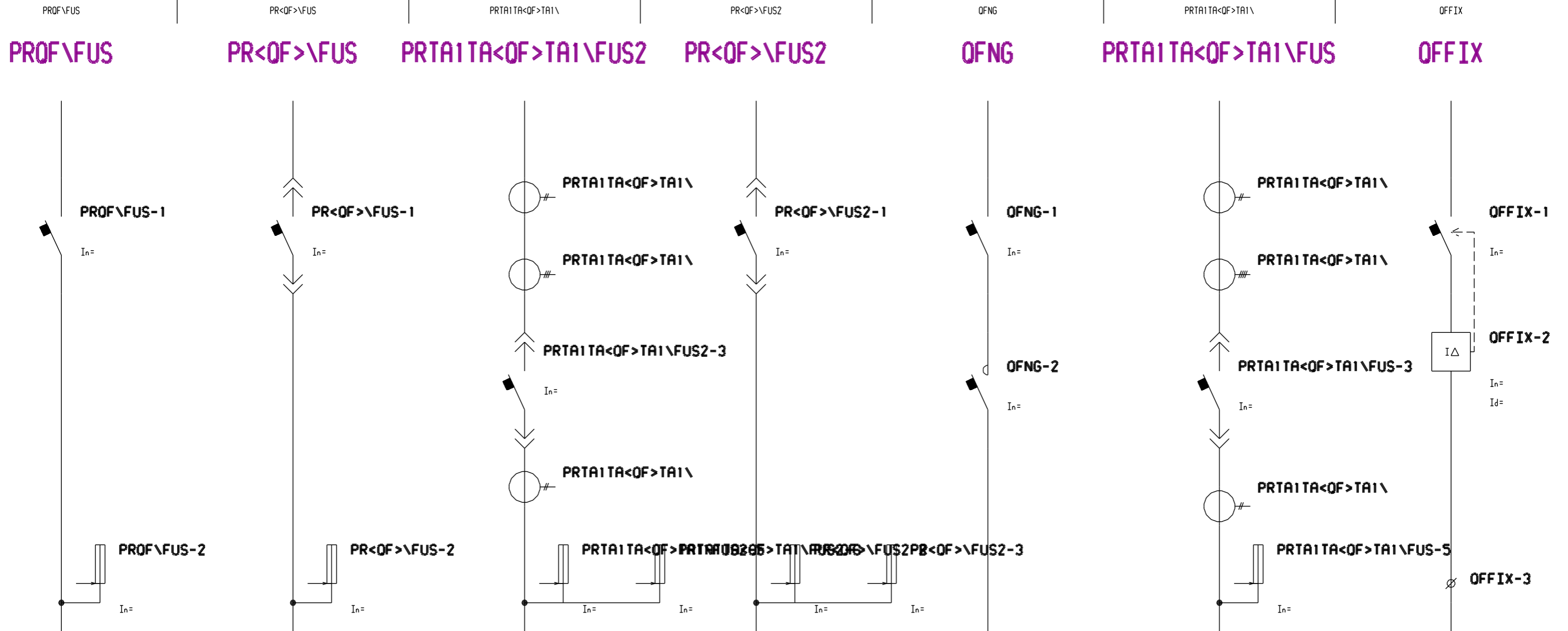

<QF>RA

PR<QF>\FUSITA1

PR<QM>\TVV\QTAT

<QF>RARA

<QF>RA

PR<QF>\FUSITA1

PR<QM>\TVV\QTATAA

<QF>RARA

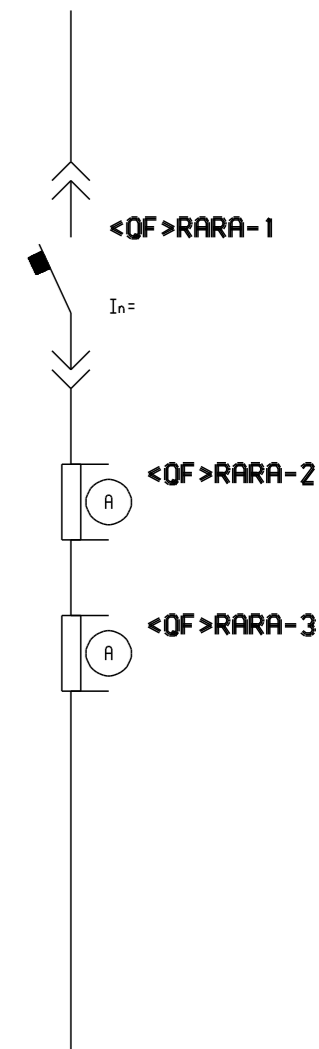
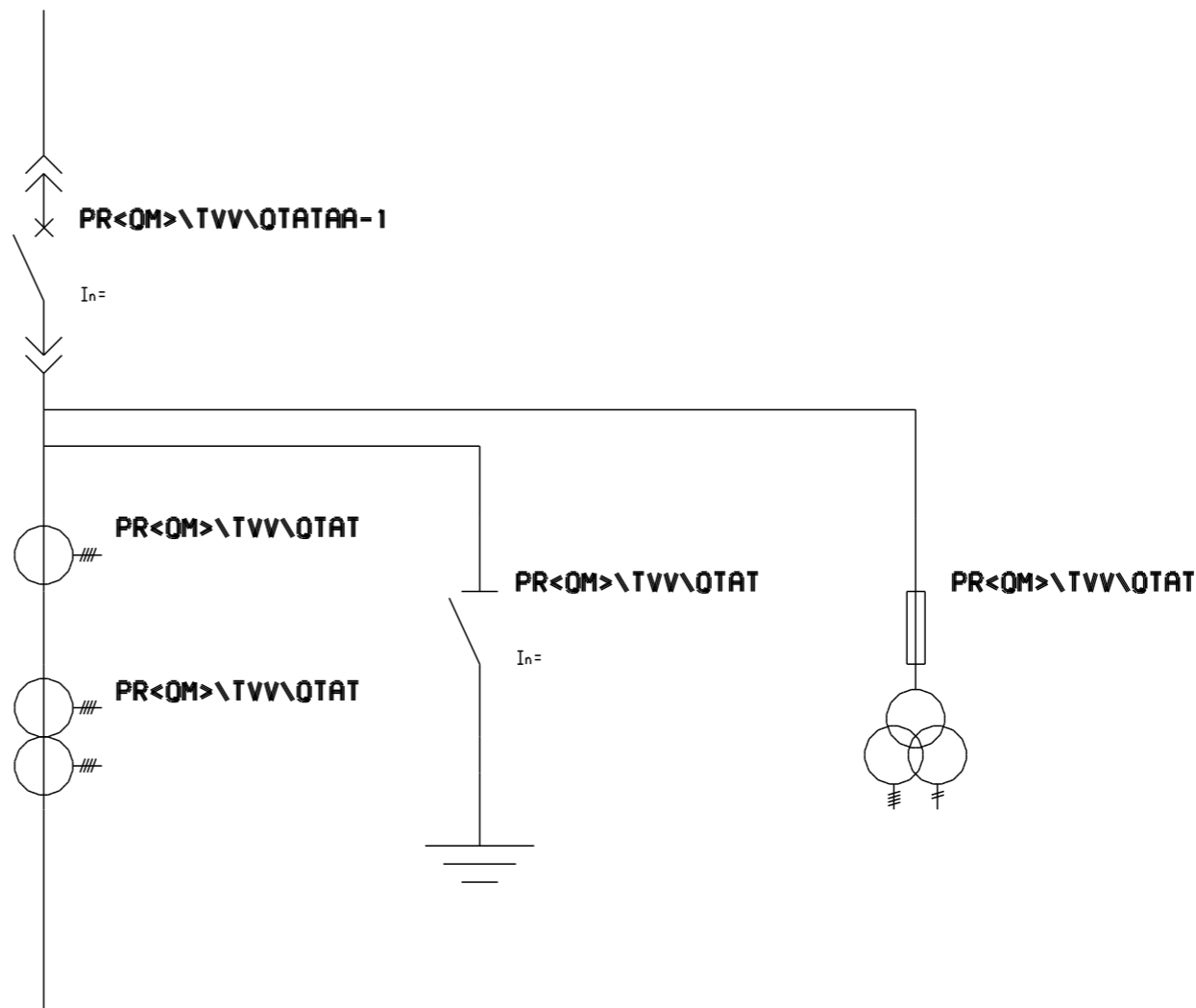
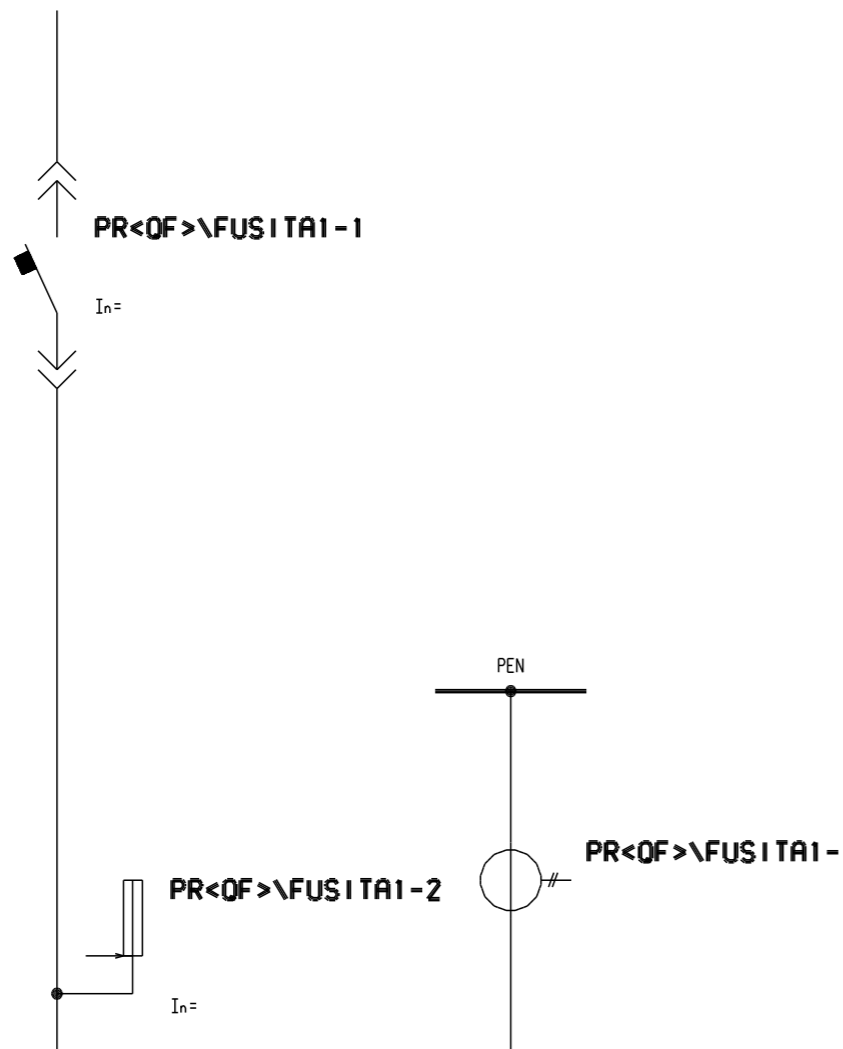
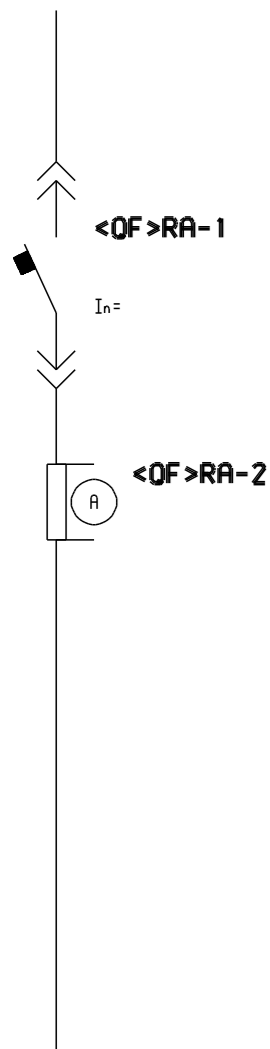

PR<QF>\FUSITA1 - 2 MODULY

PR<QM>\TVV\QTATAA - 3 MODULY

PROF\FU

QFVK

FUSOMRA

OFFAKM

OFFAKM2

OFI

NG2OF

PROF\FU

QFVK

FUSOMRA

OFFAKM

OFFAKM2

OFI

NG2OF

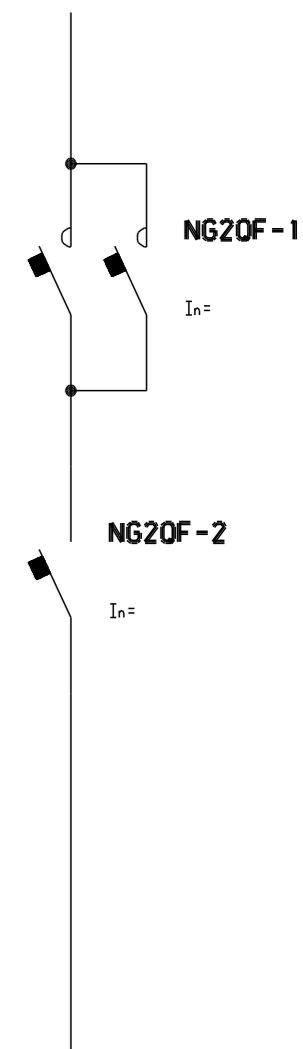
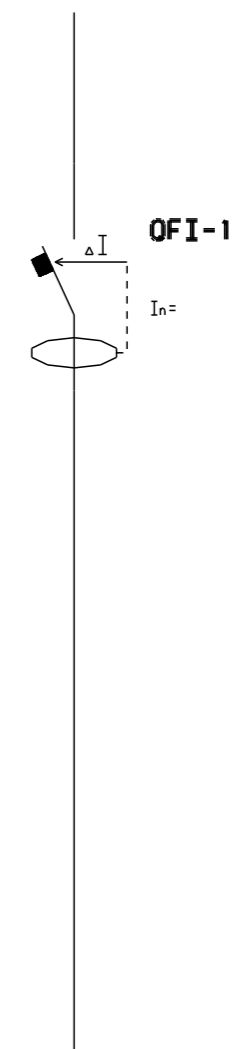
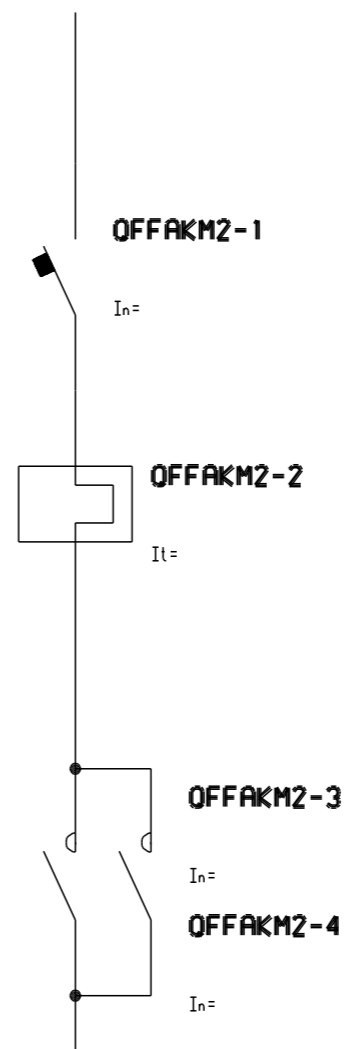
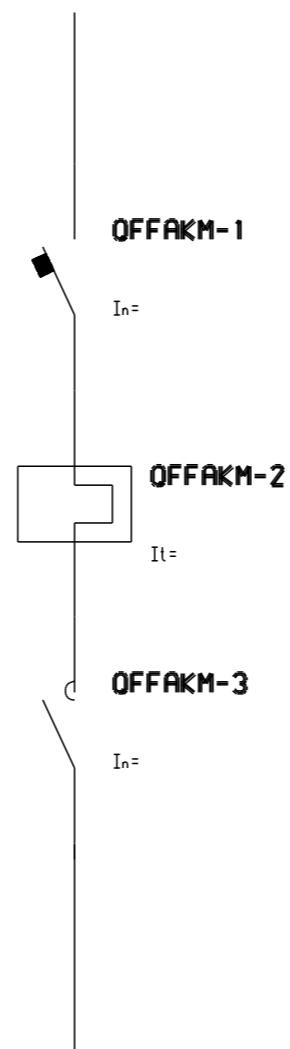
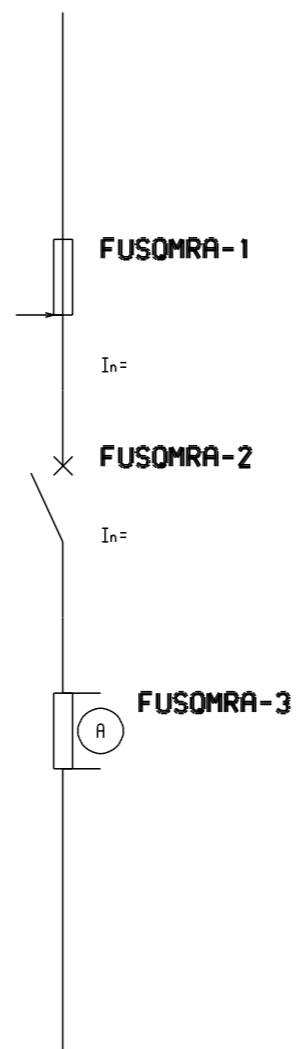
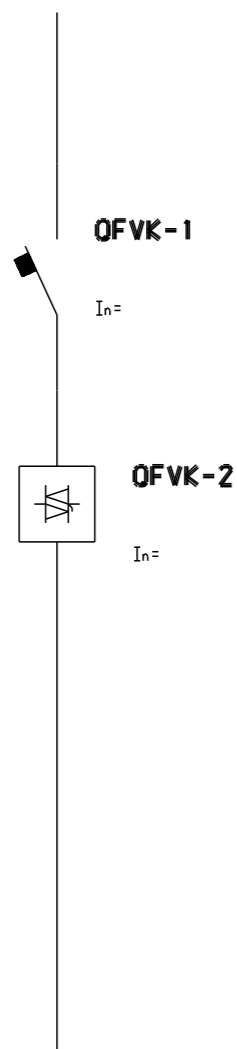
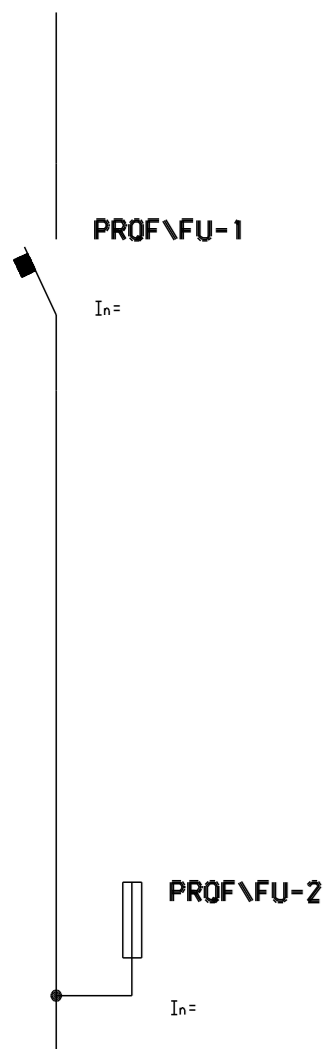

PROFRA\OF

PROFRAGU\OVL0M

OF3KM

OF2KM

PROFRA\OF

PROFRAGU\OVL0M

OF3KM

OF2KM

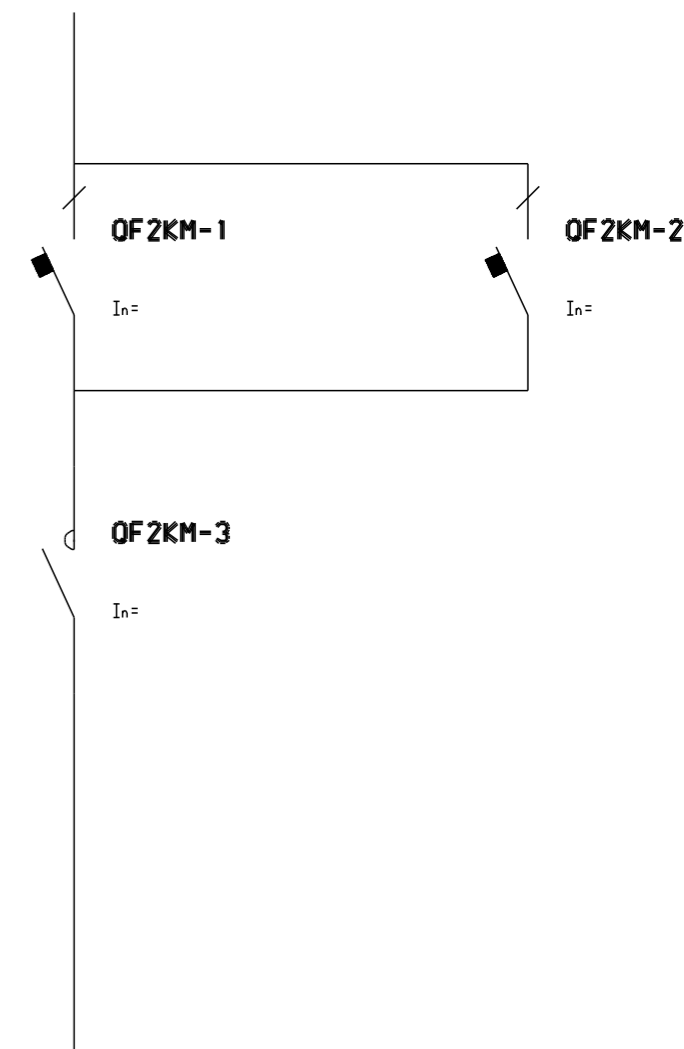
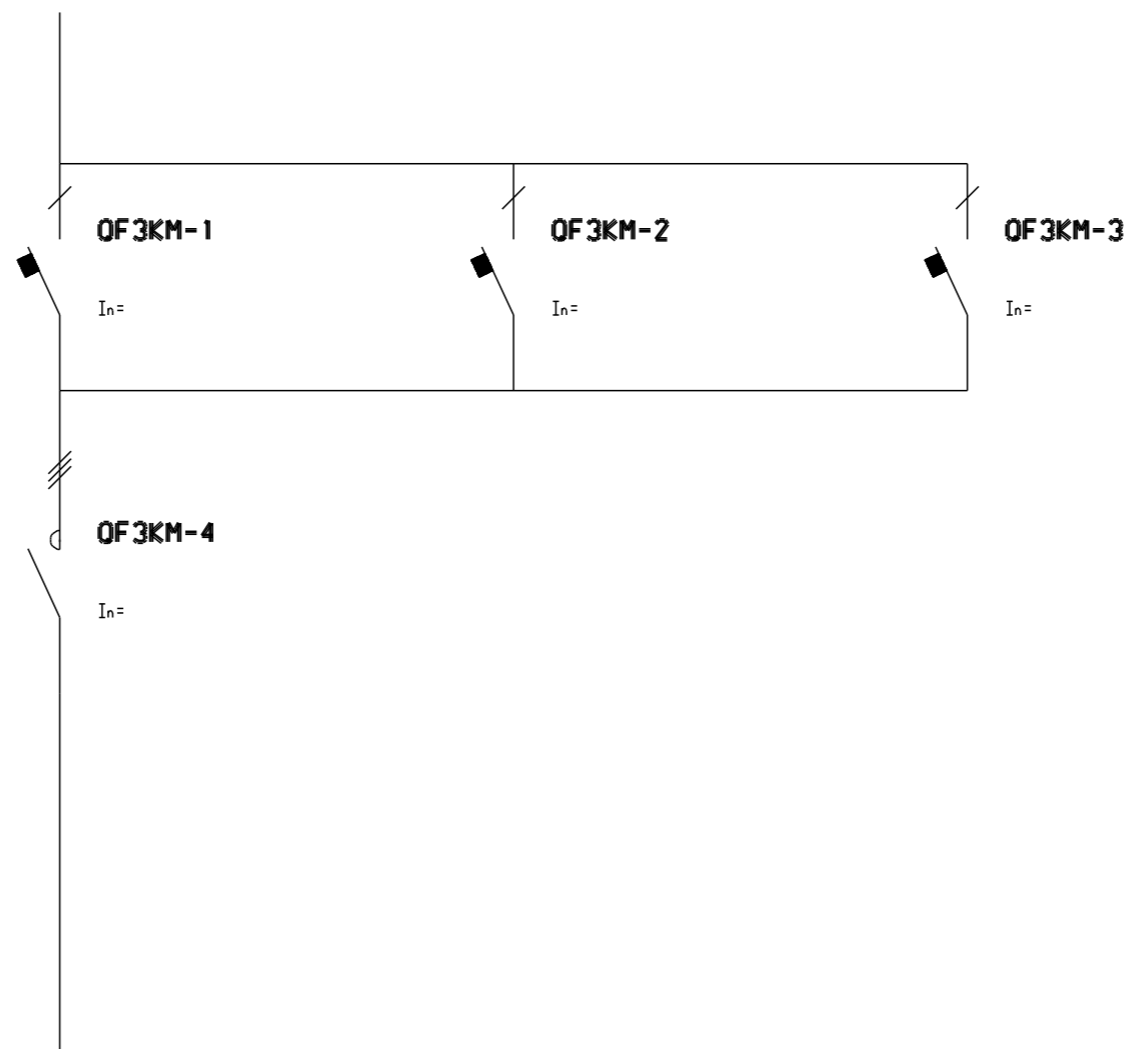
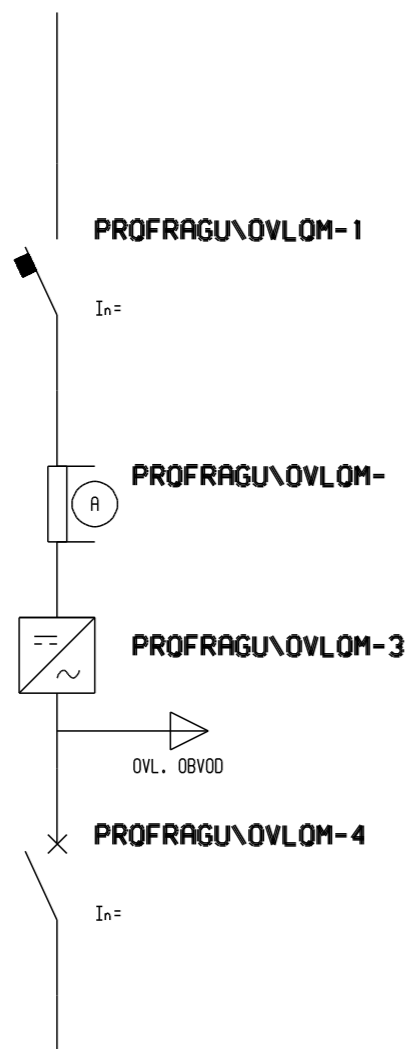
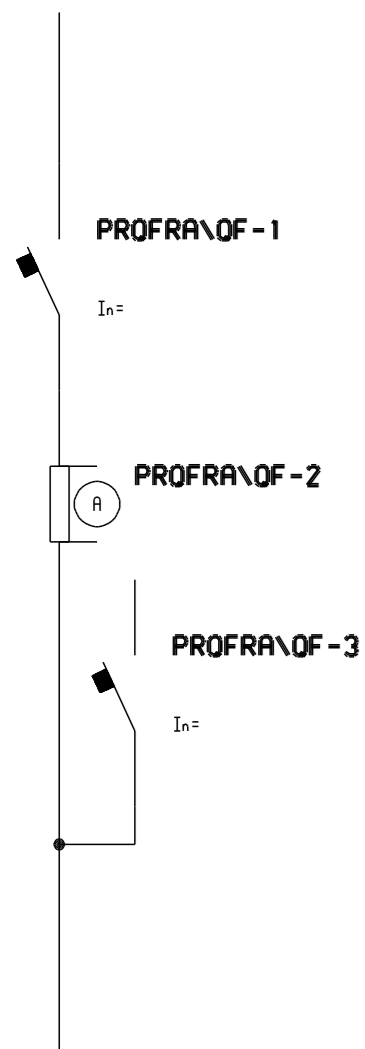

OF3KM - 3 MODULY

OF2KM - 2 MODULY

OF3NG

OF3NG

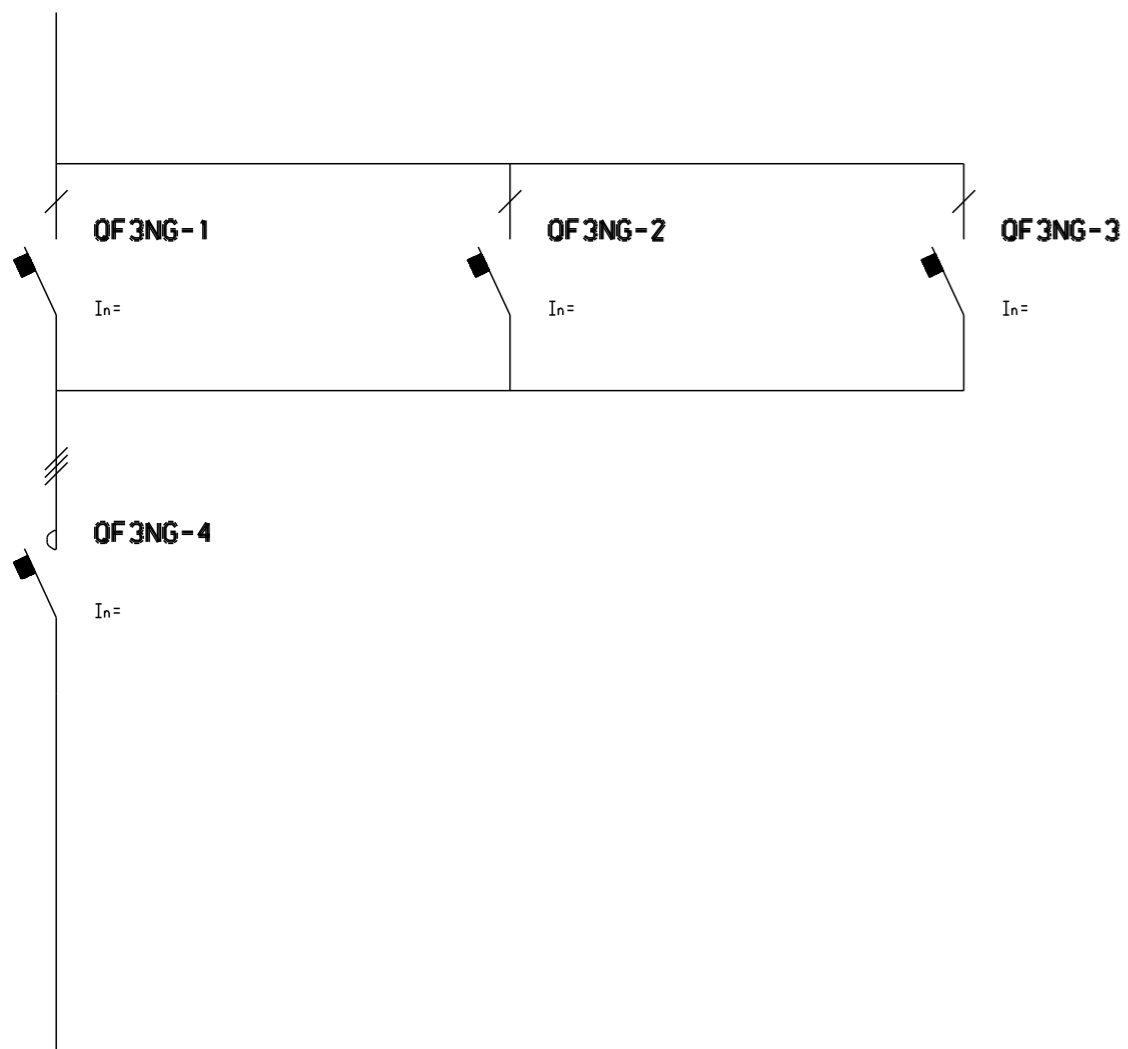

OF3NG - 3 MODULY

OF2

OF2

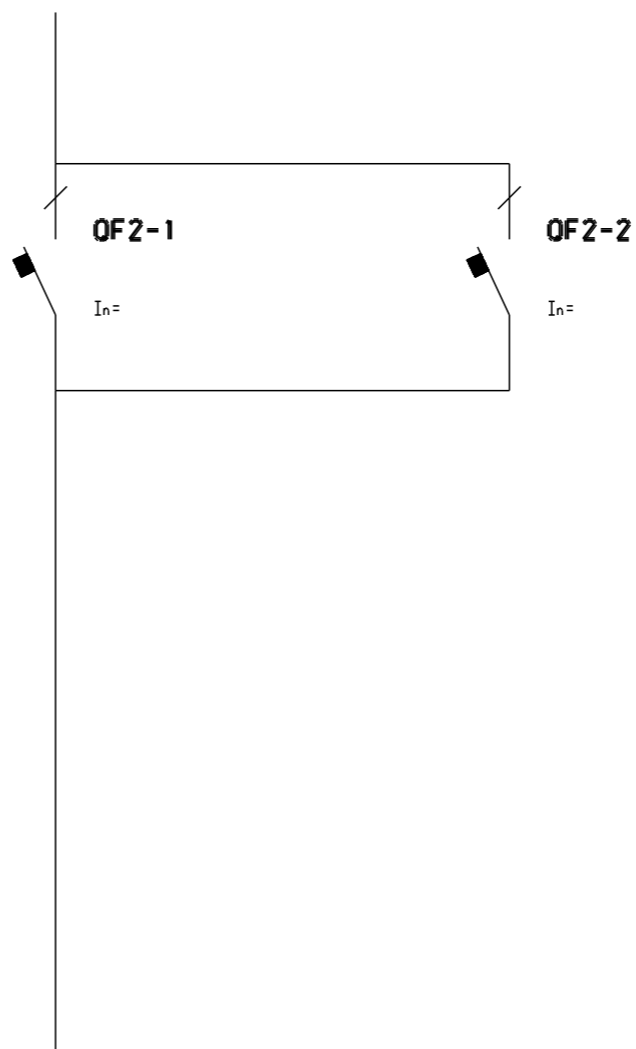

OF2 - 2 MODULY

OFFIO

OFFIO

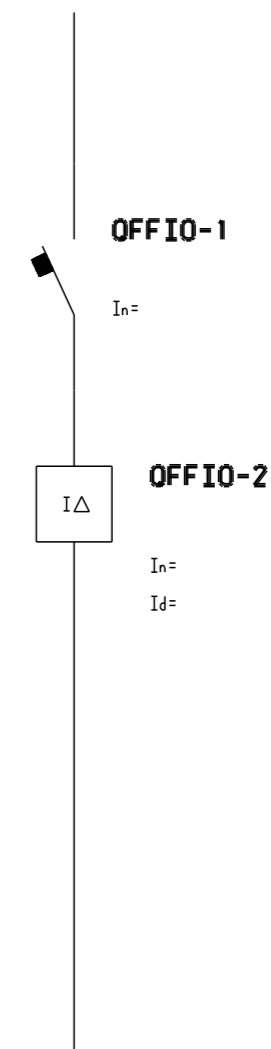

OFUU

OFUU

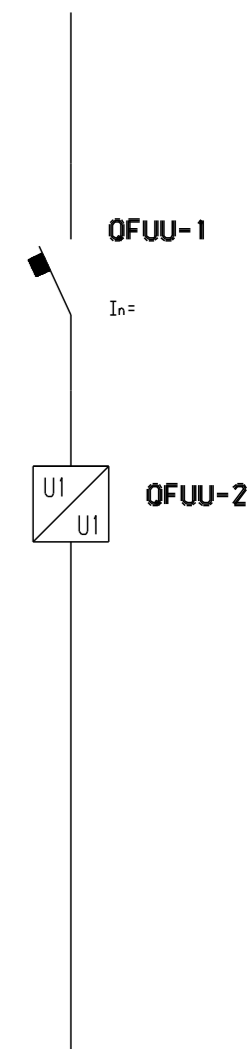

OFUU\OVLKM

PRTAQF

<OF><OF>FAN

<OF><OF>

OFOM_

OF_OM

OF<OF>

OFUU\OVLKM

PRTAQF

<OF><OF>FAN

<OF><OF>

OFOM_

OF_OM

OF<OF>

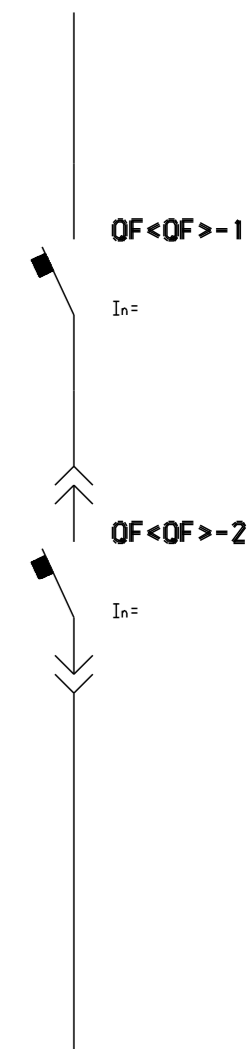
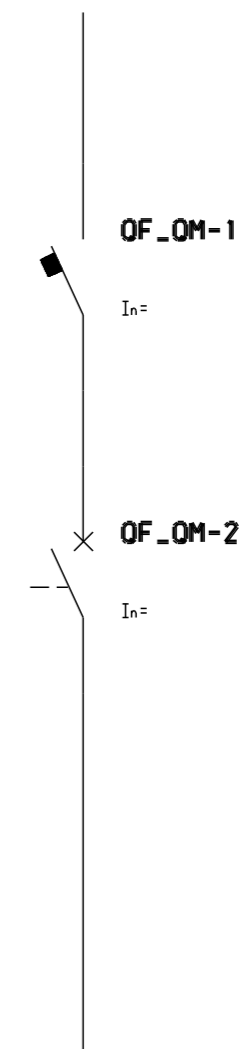
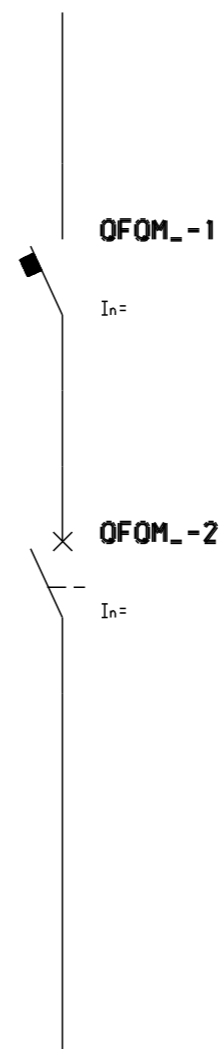
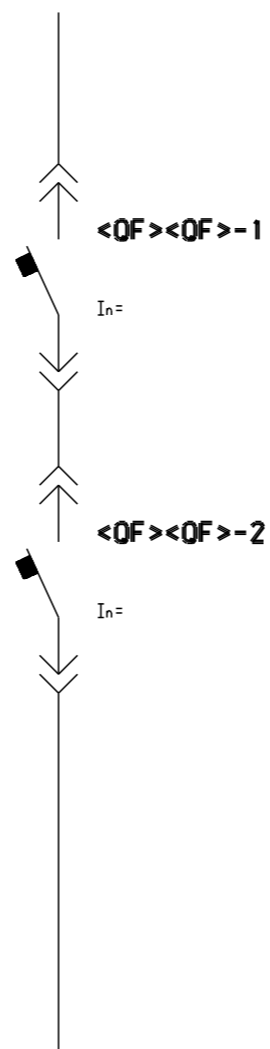
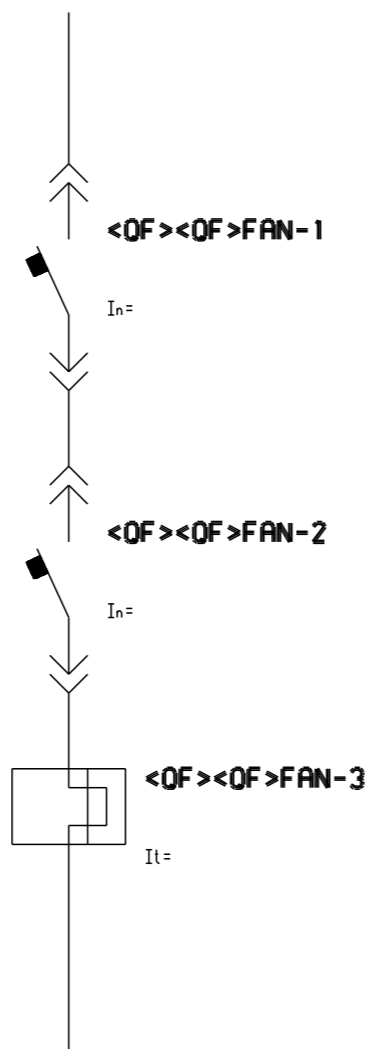
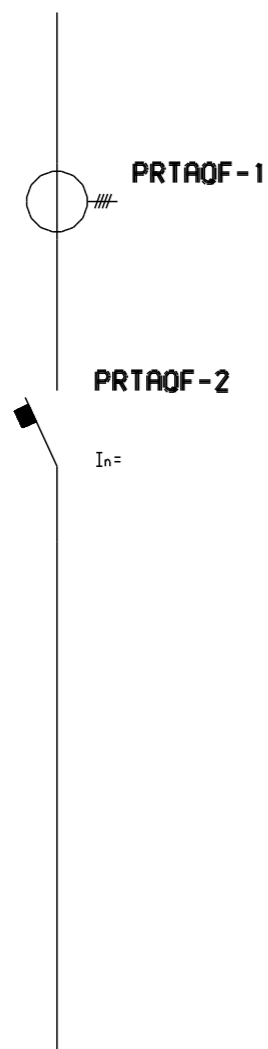
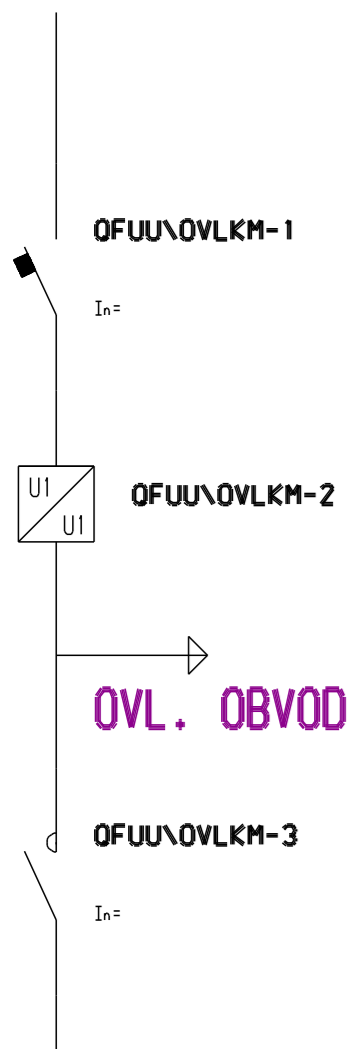

<OF>\FUSZUP

<OF>TAFAN

OFFV

OFKMFA

OFKM2FA

<OF>OF1.2

OFPARPR

<OF>\FUSZUP

<OF>TAFAN

OFFV

OFKMFA

OFKM2FA

<OF>OF1.2

OFPARPR

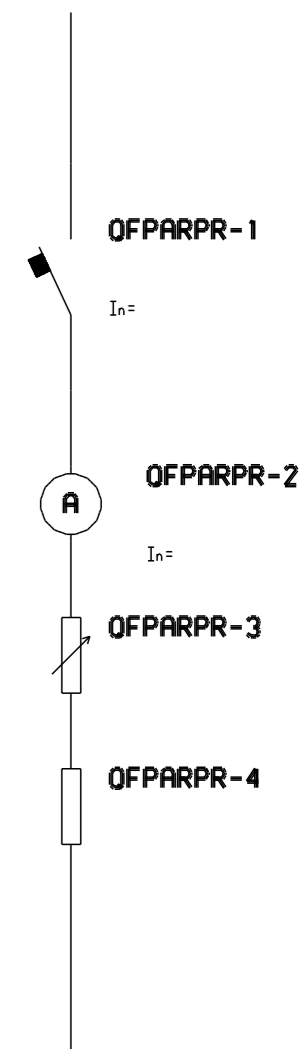
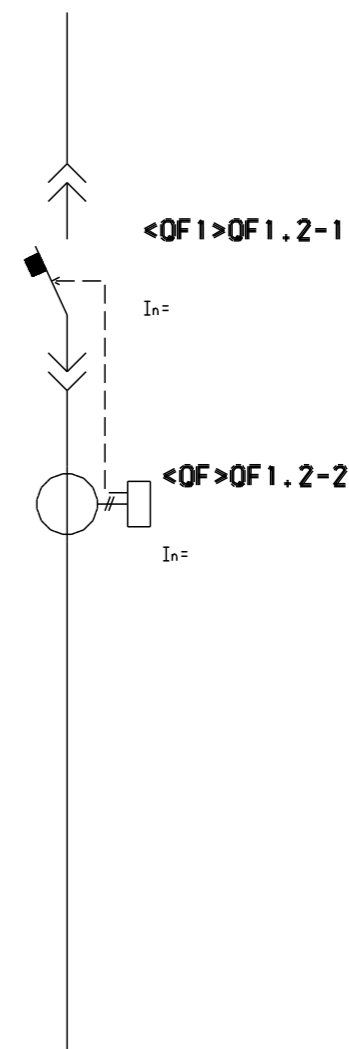
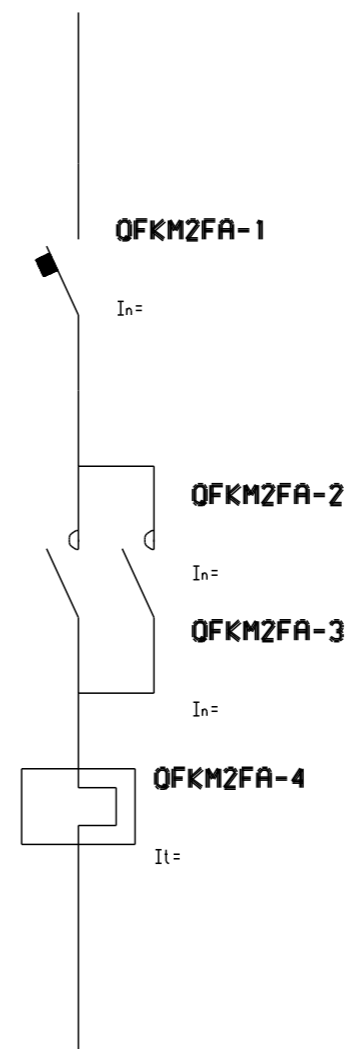
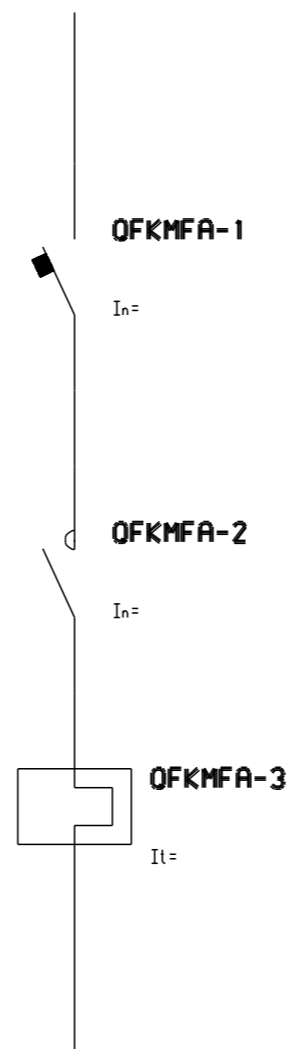
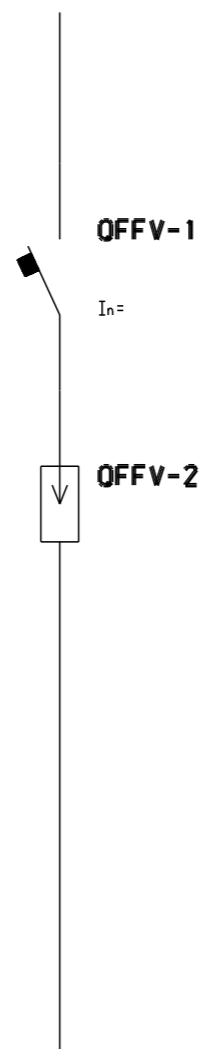
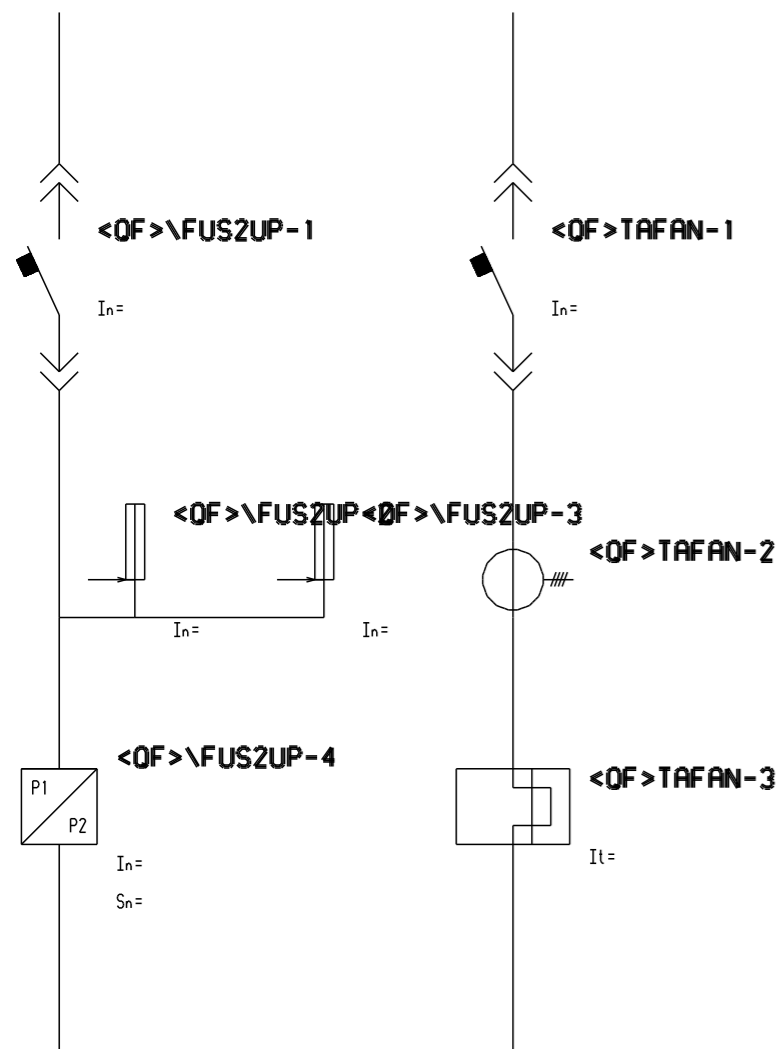

OFTA

OFTAQF

<QF>TAQF1.2

OFTA1

<QF>RA\FUS

<QF>TATA1\FUS

PR<QF>TATA1\FUS

OFTA

OFTAQF

<QF>TAQF1.2

OFTA1

<QF>RA\FUS

<QF>TATA1\FUS

PR<QF>TATA1\FUS

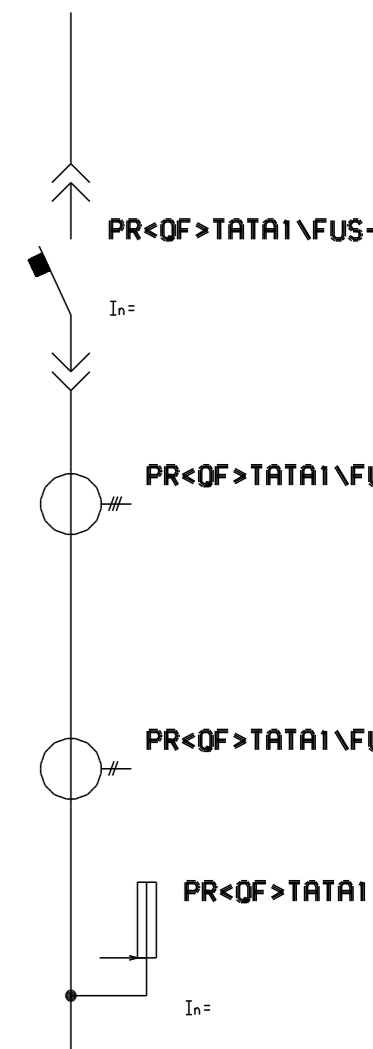
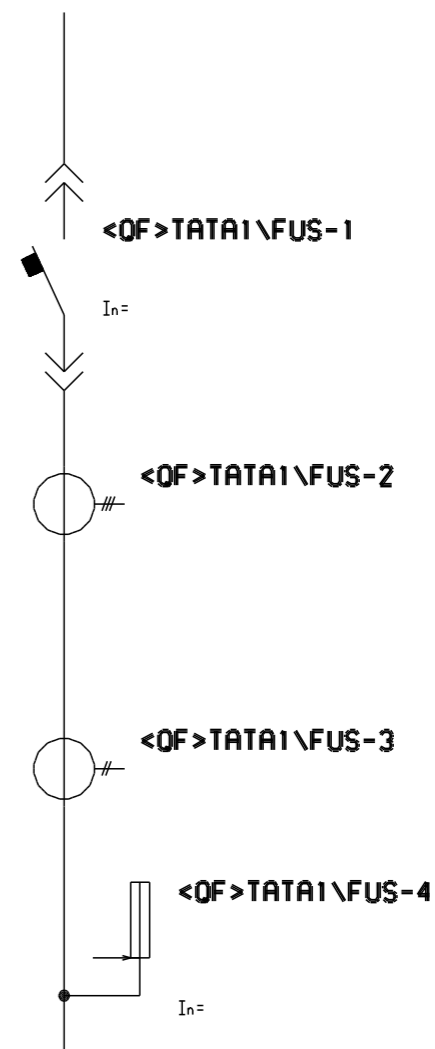
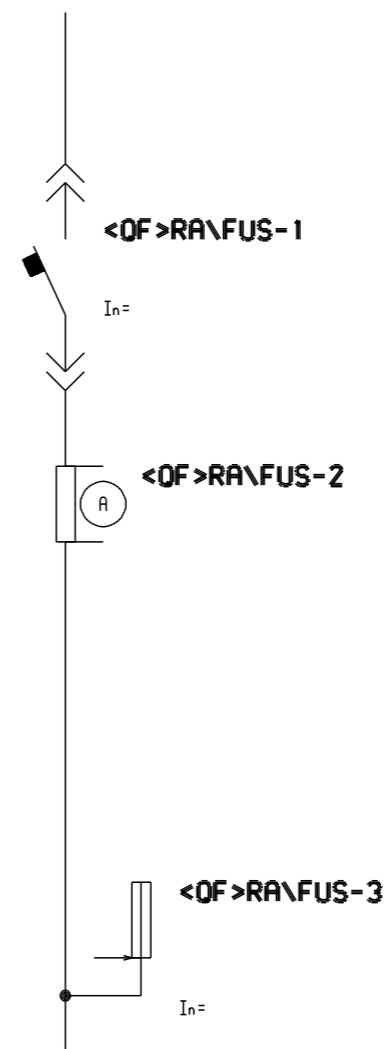
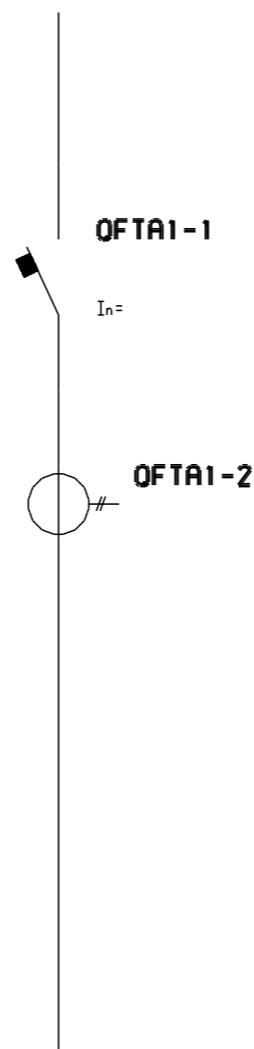
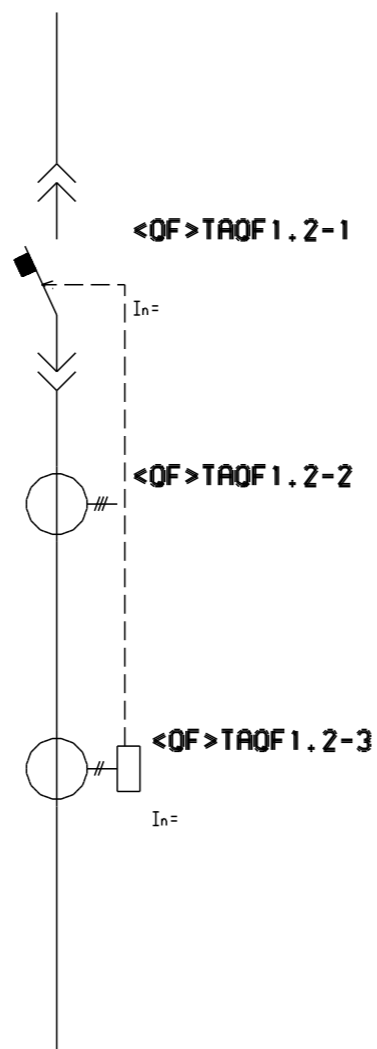
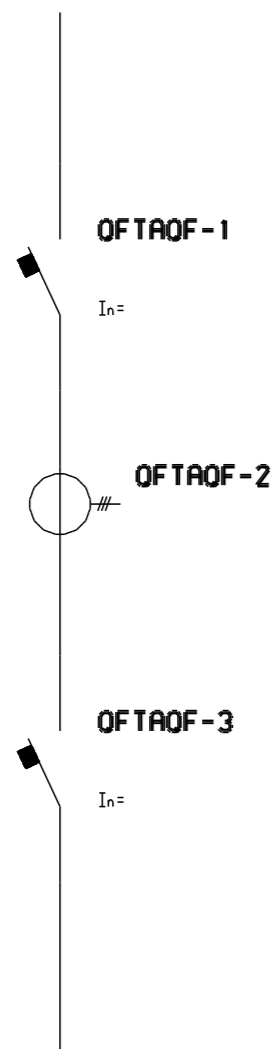
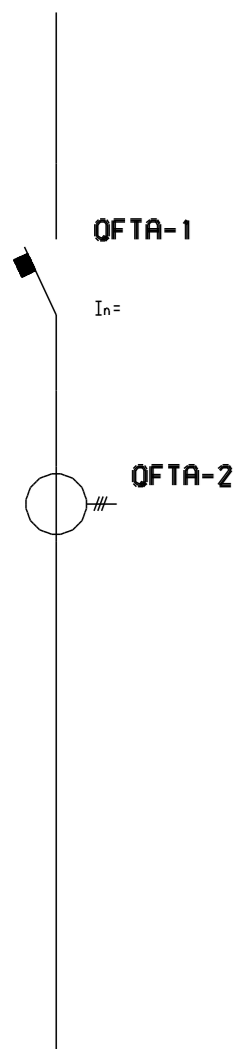

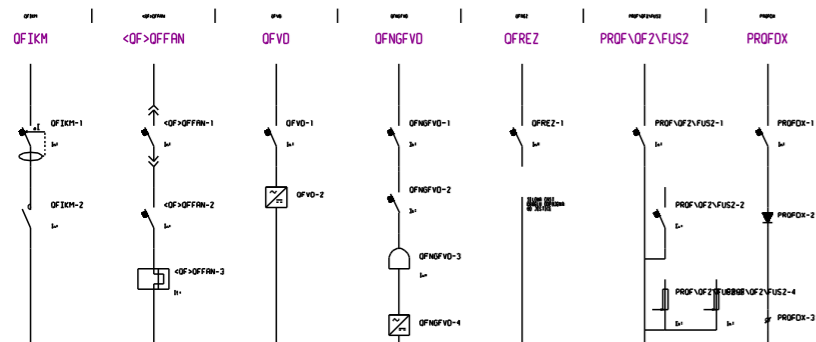

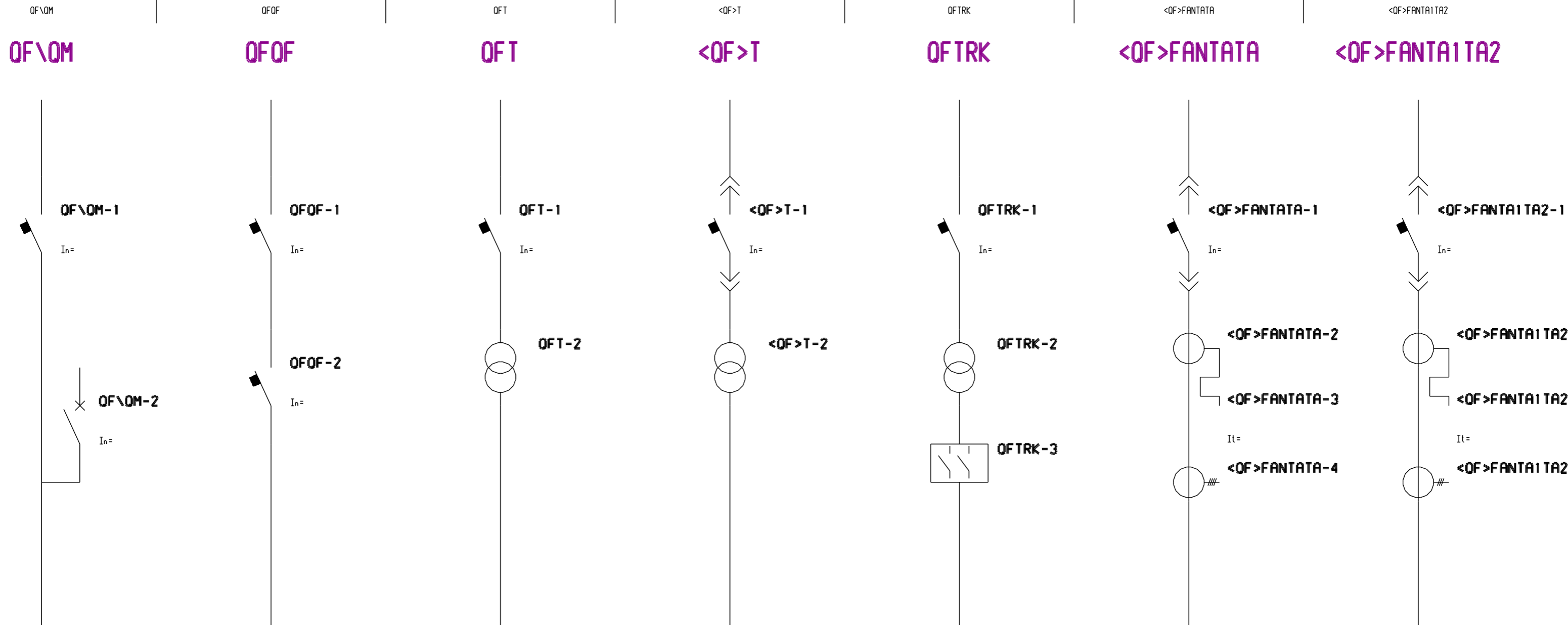

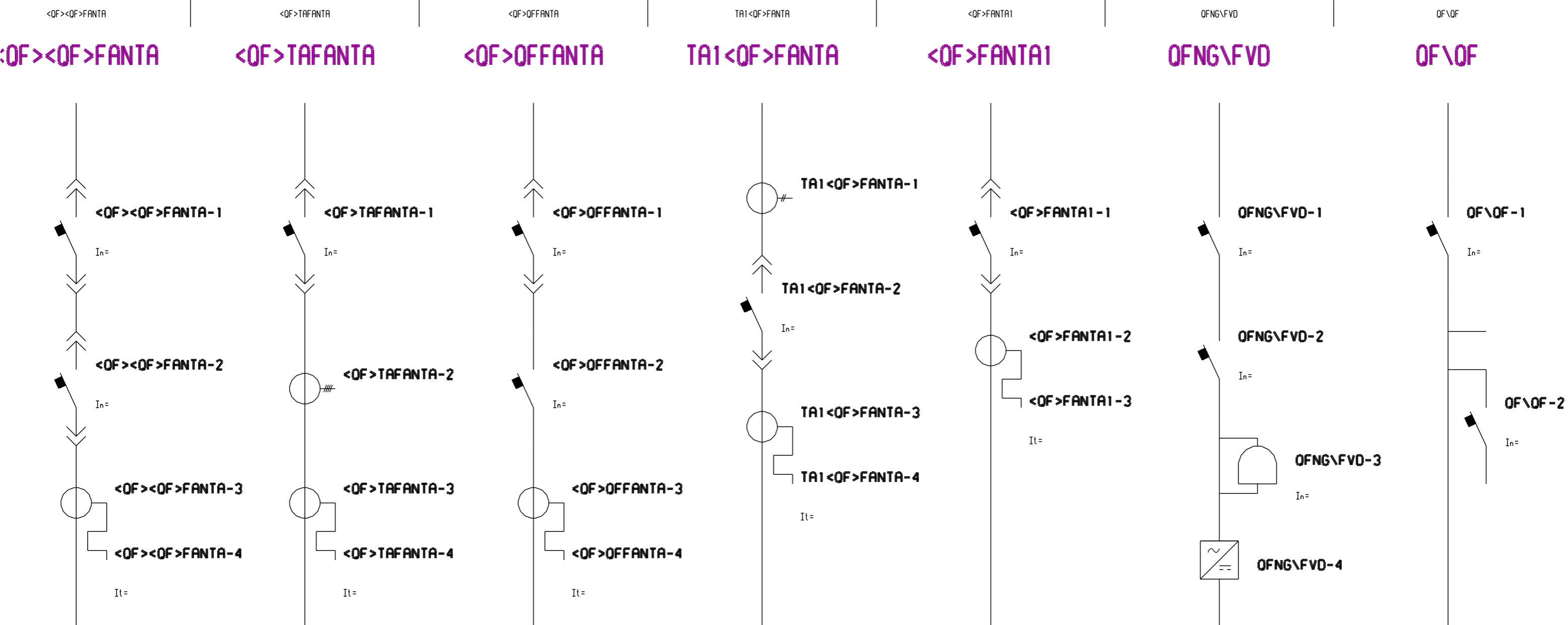

OFFV1 QFTAKM\KMFA\KM\QFTOGUKM\QFQF

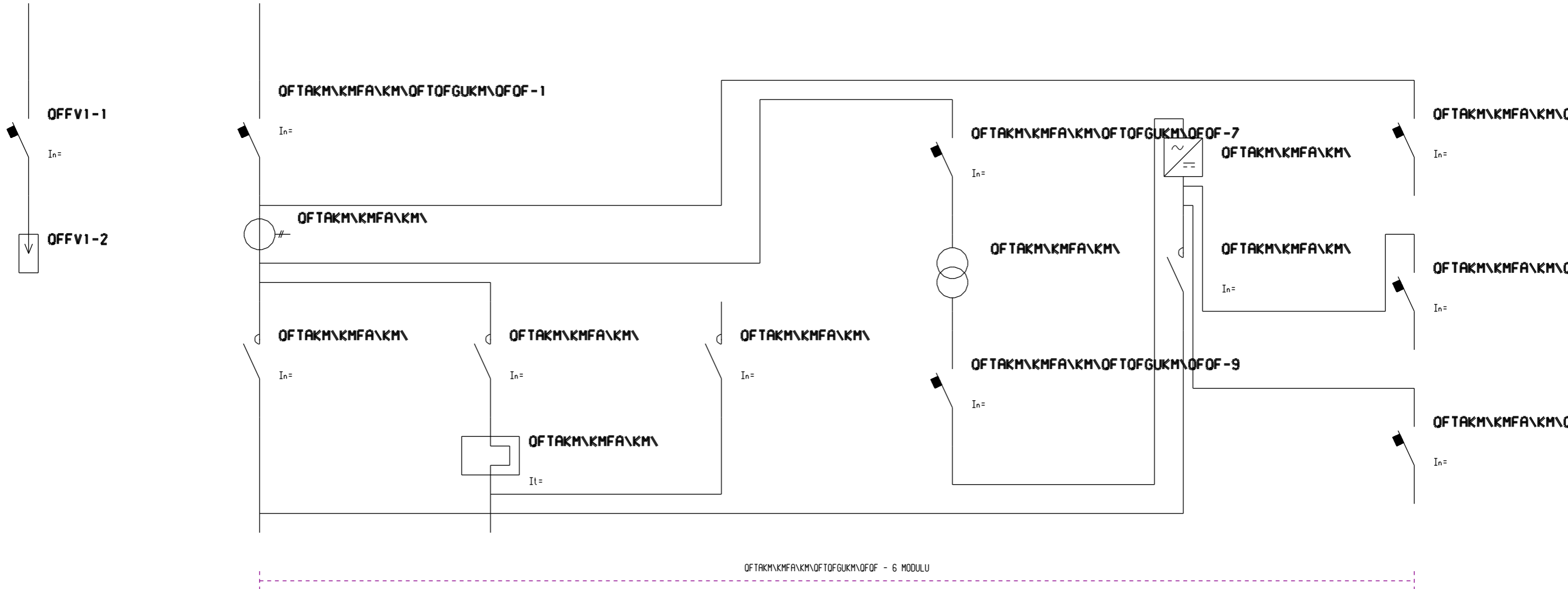

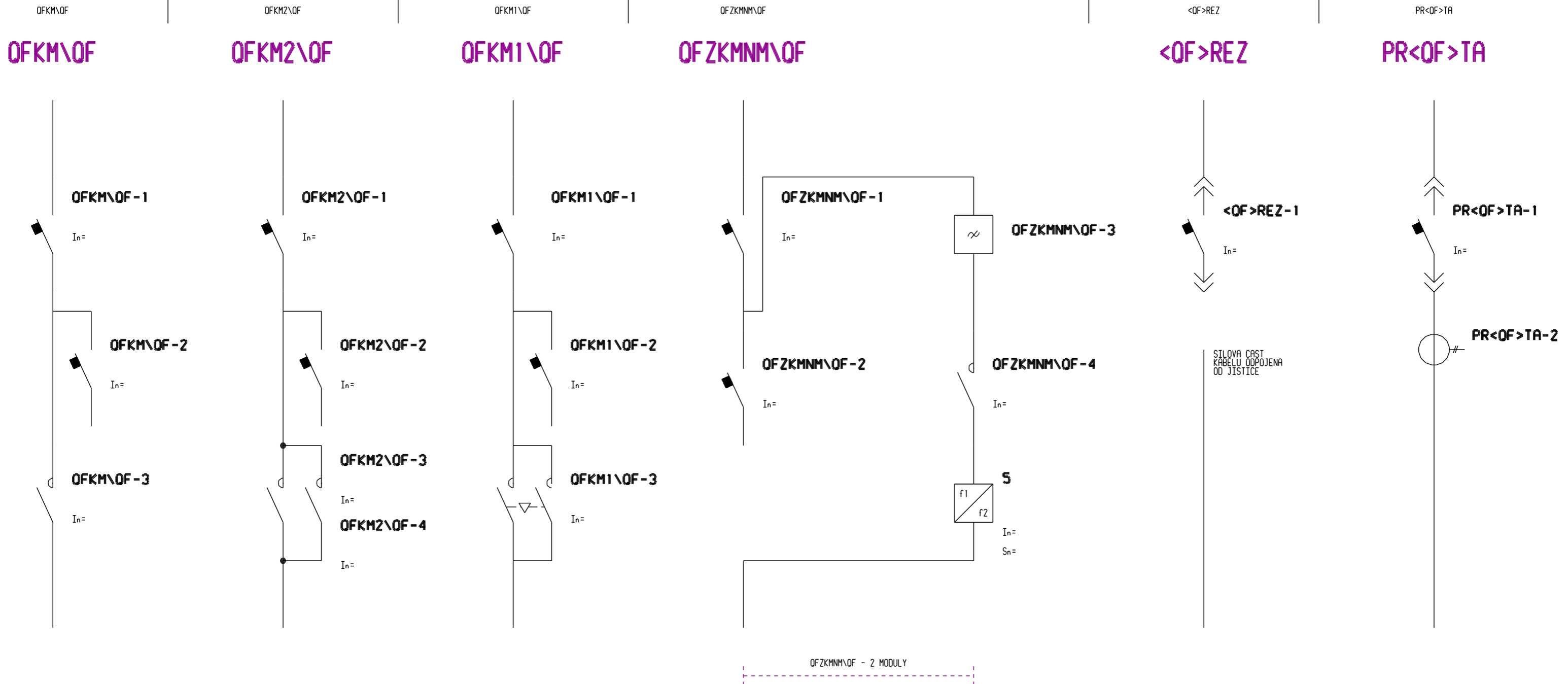

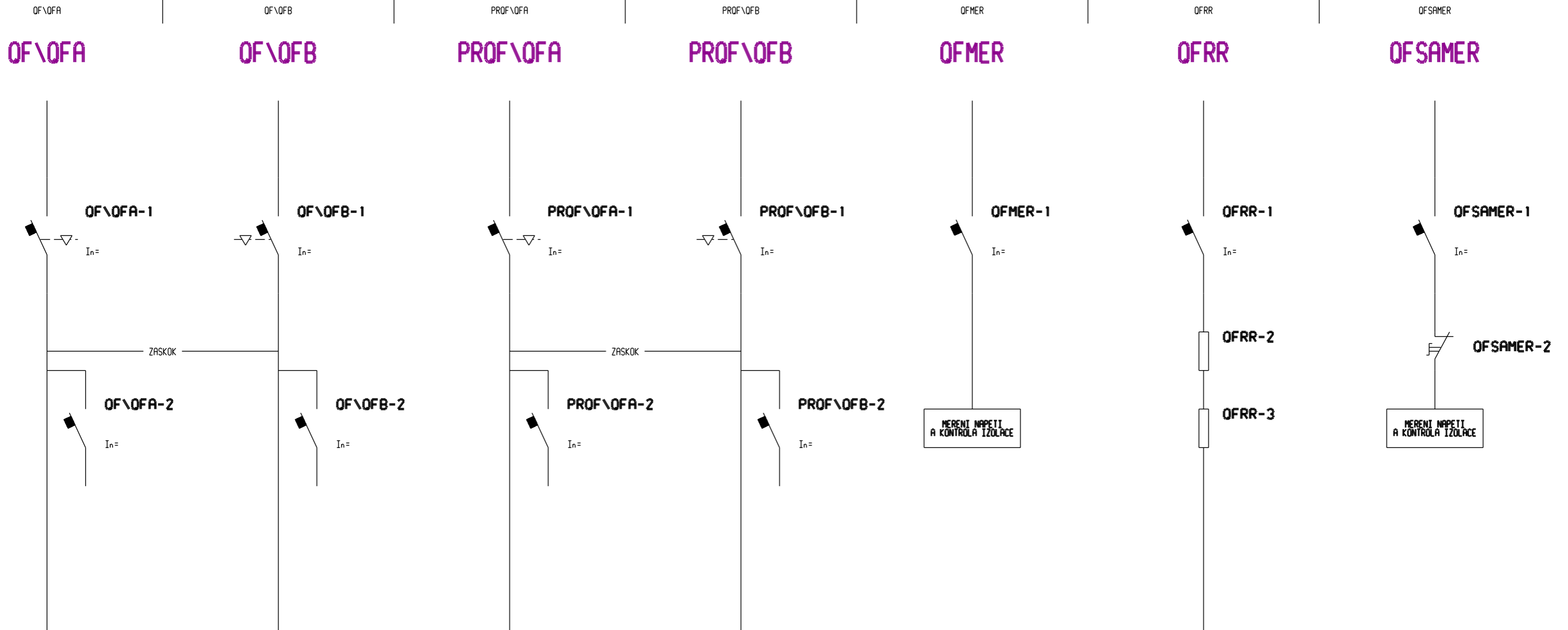

PR<OF>\FUSQFQ I

OF3PNG2

OF3PKM2

OFZV

OFFM

PR<OF>\FUSQFQ I TA1

OF3PNG2

OF3PKM2

OFZV

OFFM

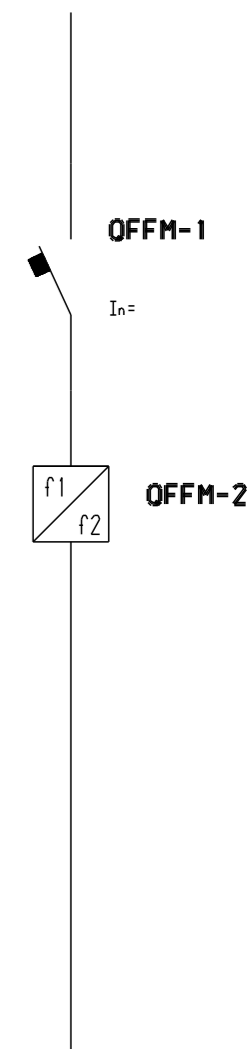
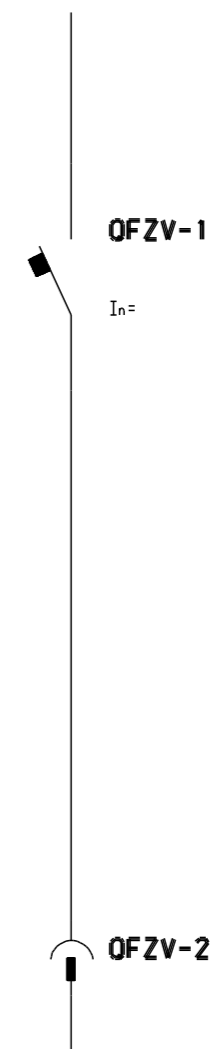
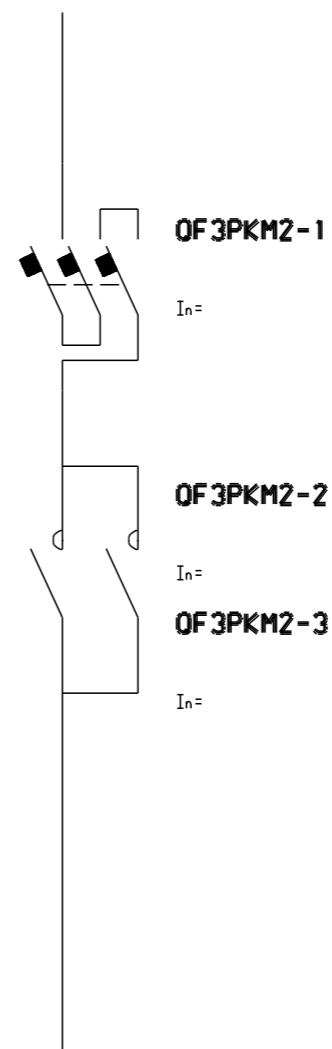
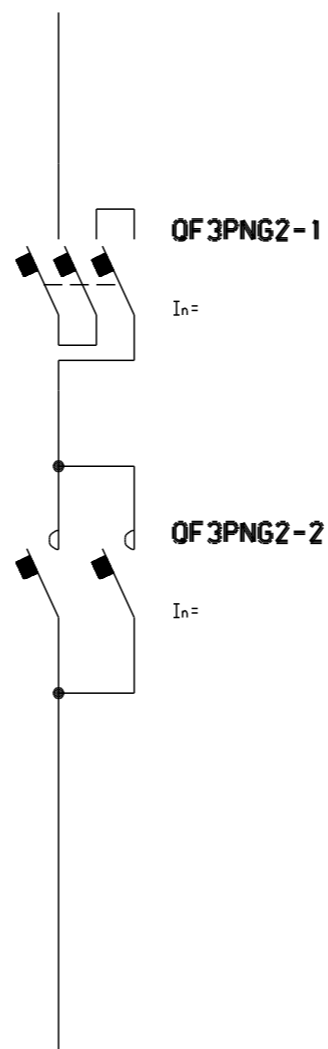
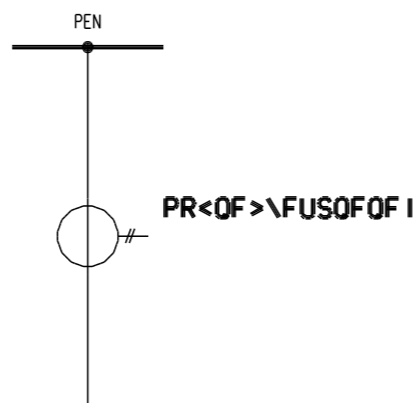
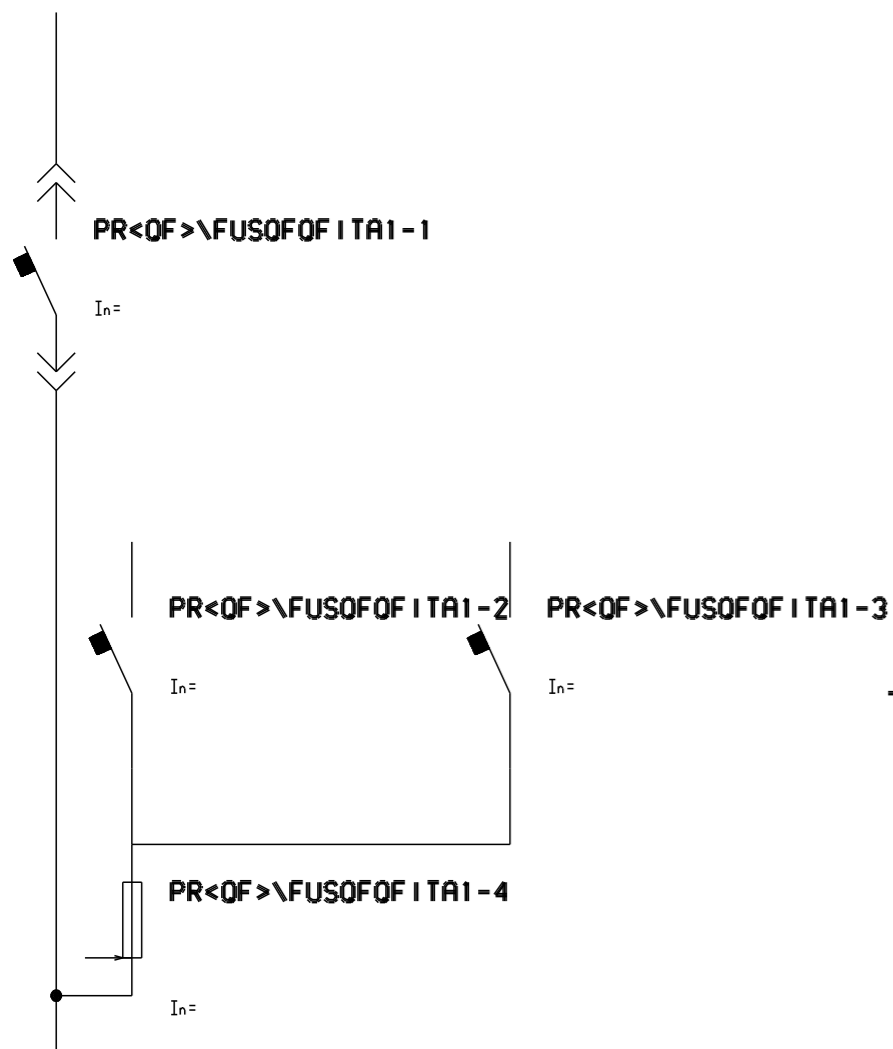

PR<OF>\FUSQFQ I TA1 - 3 MODULY

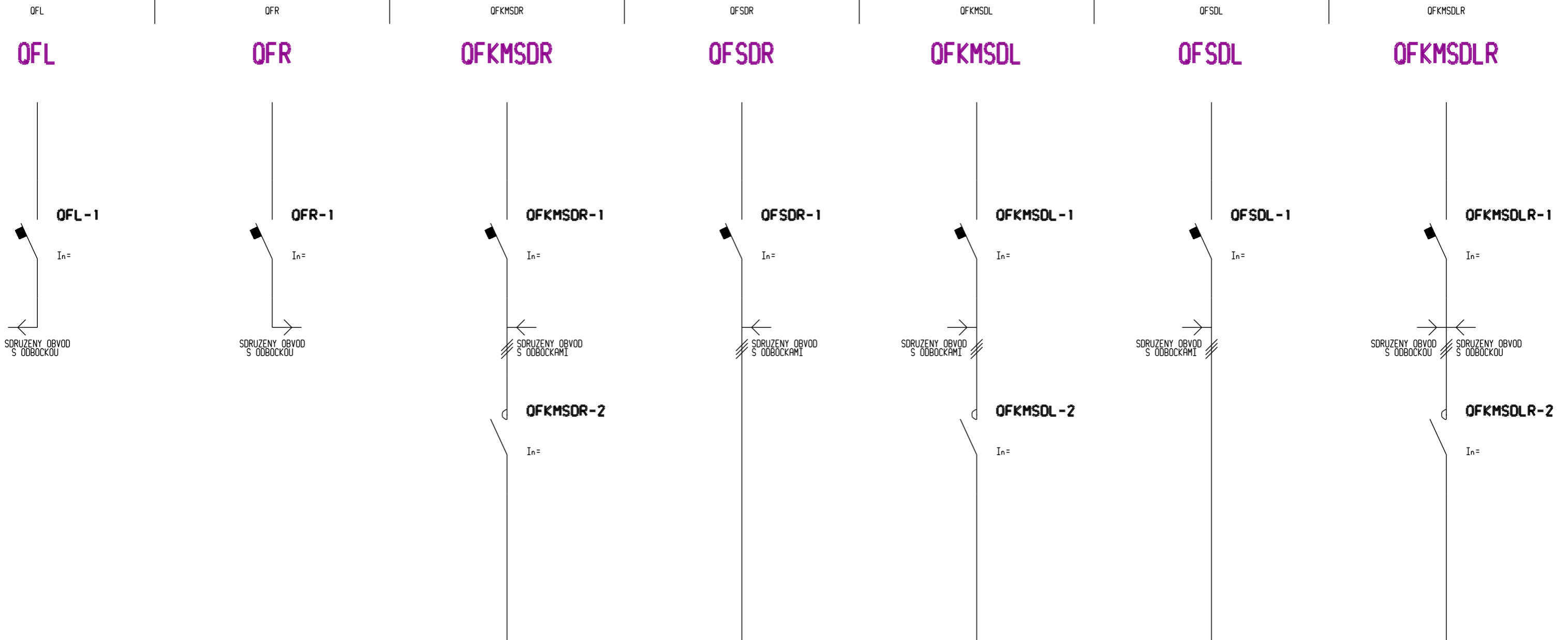

SPOLECNY KABEL S ODBOCKOU

SPOLECNY KABEL S ODBOCKOU

OFSDLR

OFLGY

OFRGY

QFKMSDR2

QFSDR2

QFKMSDL2

OFSDL2

OFSDLR

OFLGY

OFRGY

QFKMSDR2

QFSDR2

QFKMSDL2

OFSDL2

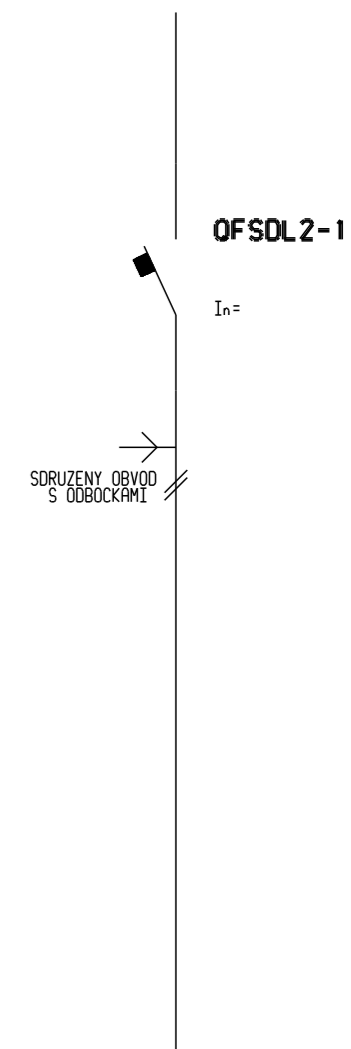
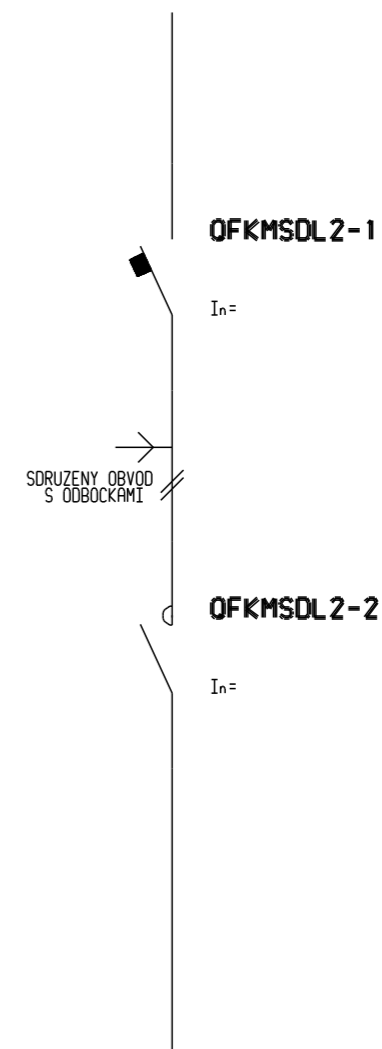
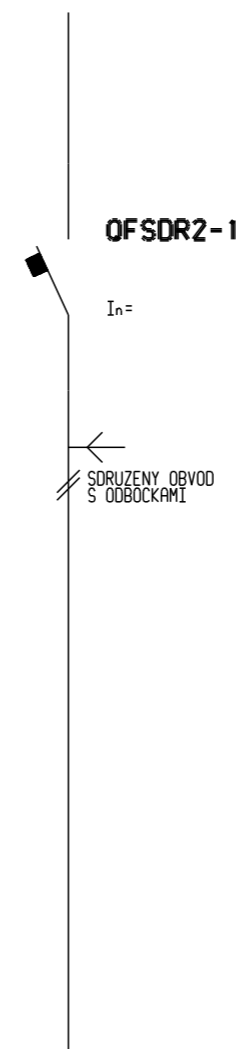
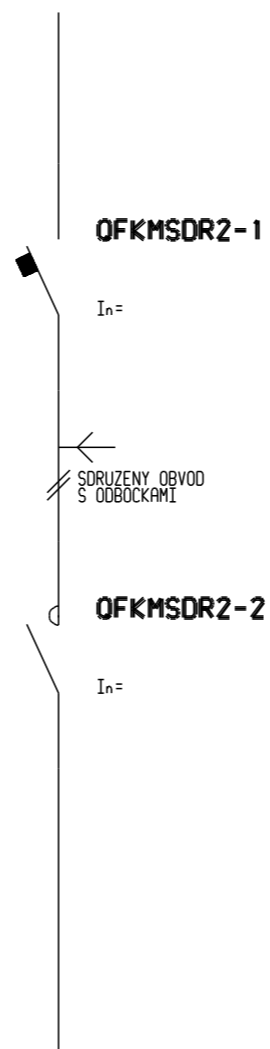
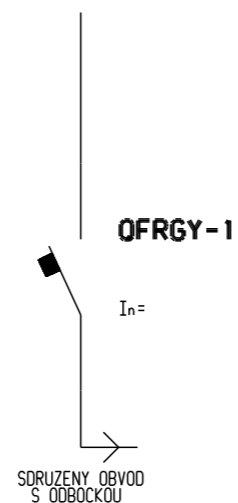
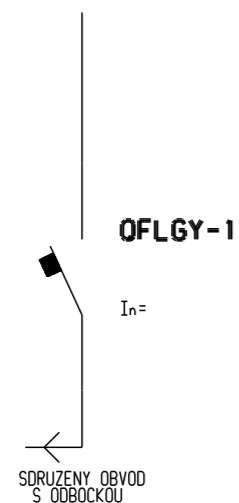
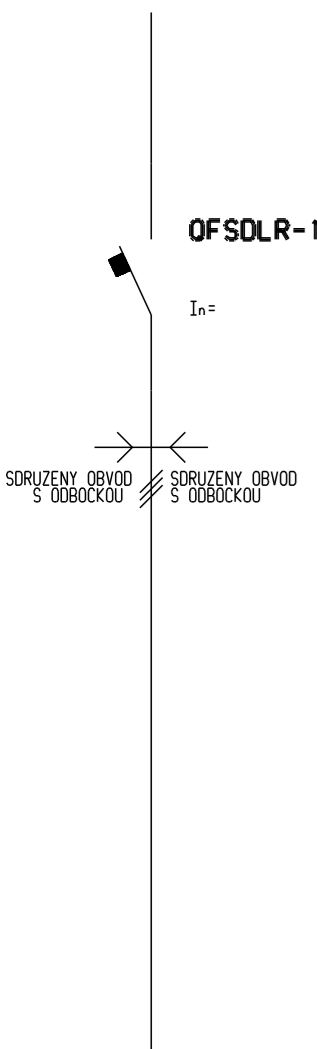

KABELY DO

KABELY DO

OFKMSDLR2

OFSDLR2

PR<OF>\OSF

PROF\OF2

OFIOFZ\OFZ

OFKMSDLR2

OFSDLR2

PR<OF>\OSF

PROF\OF2

OFIOFZ\OFZ

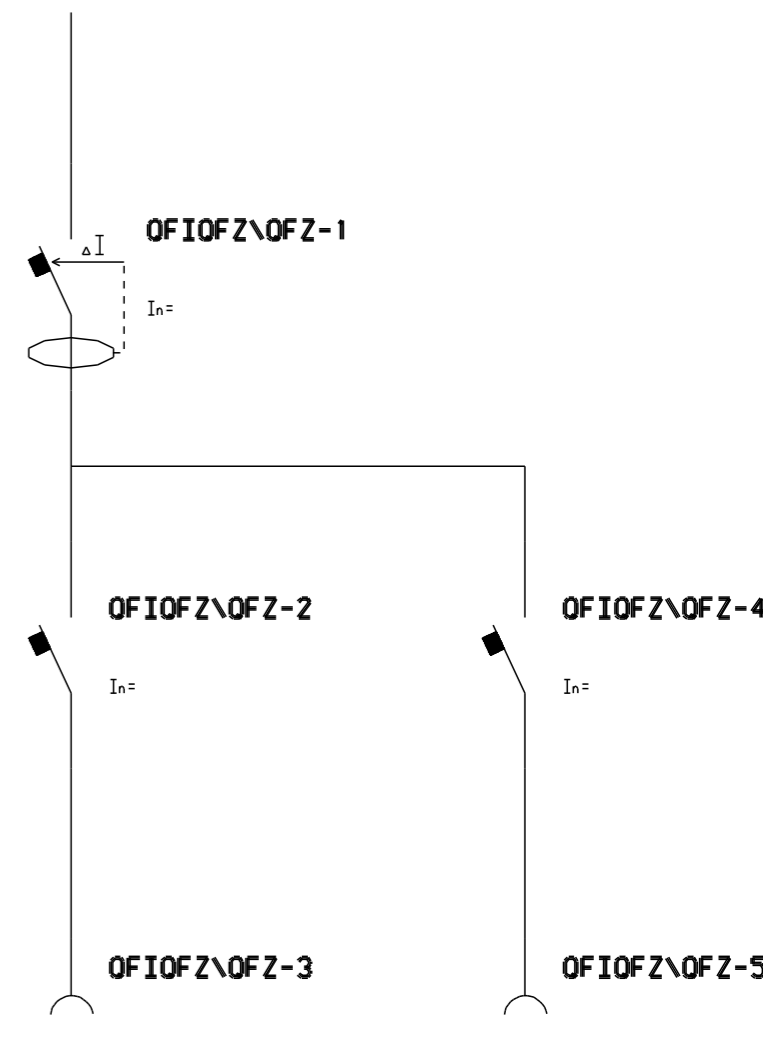
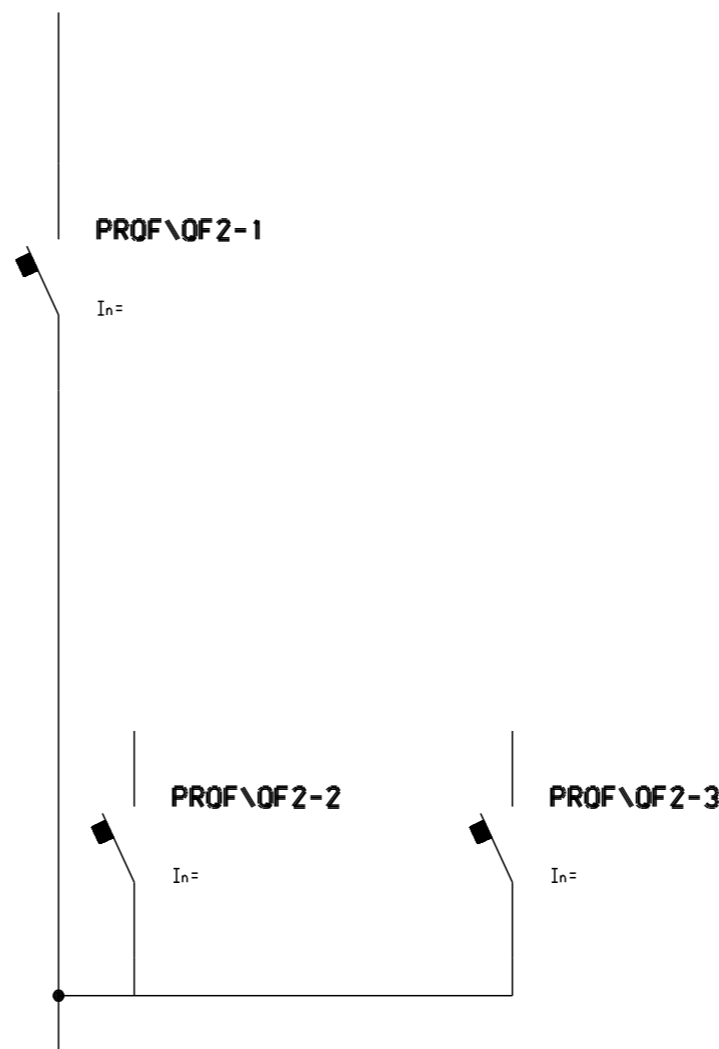
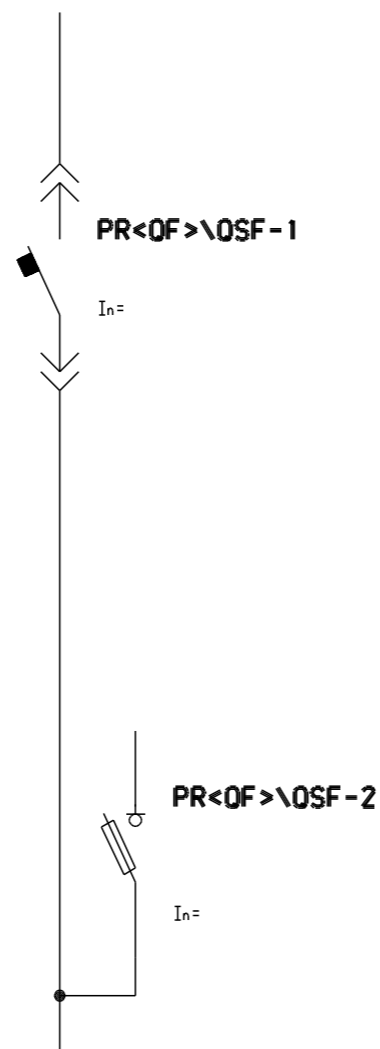
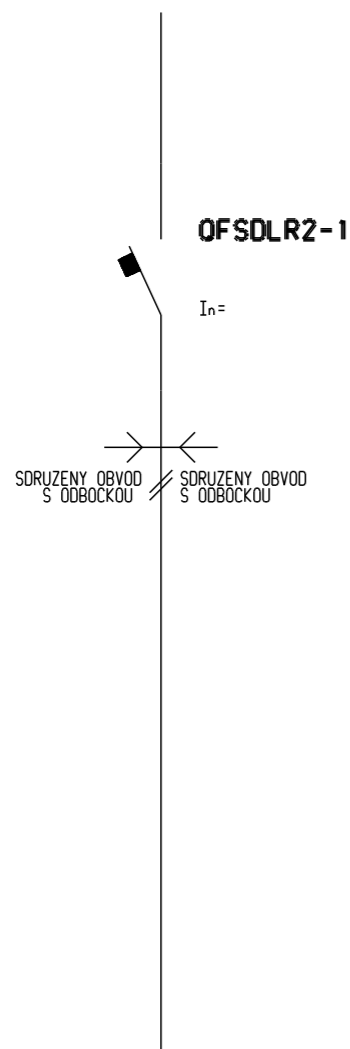
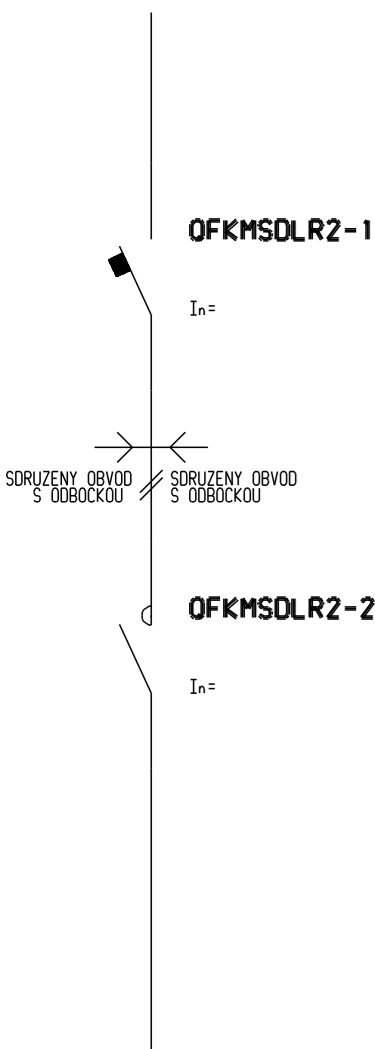

PROF\OF2 - 2 MODULY

OFIOFZ\OFZ - 2 MODULY

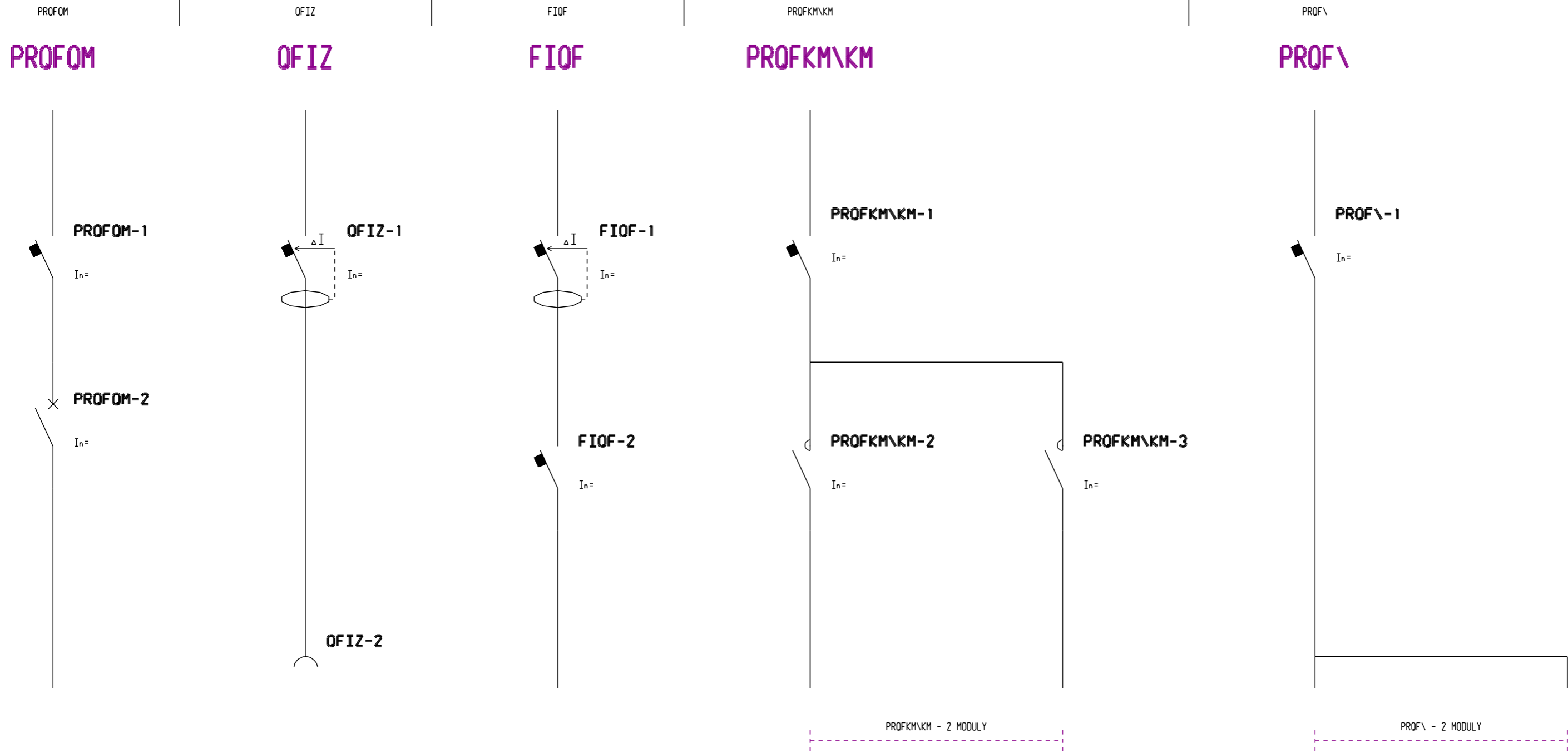

QFKMZZ\QFZ

QFKMFA\QF

QF3KMOF3

QFKMZZ\QFZ

QFKMFA\QF

QF3KMOF3

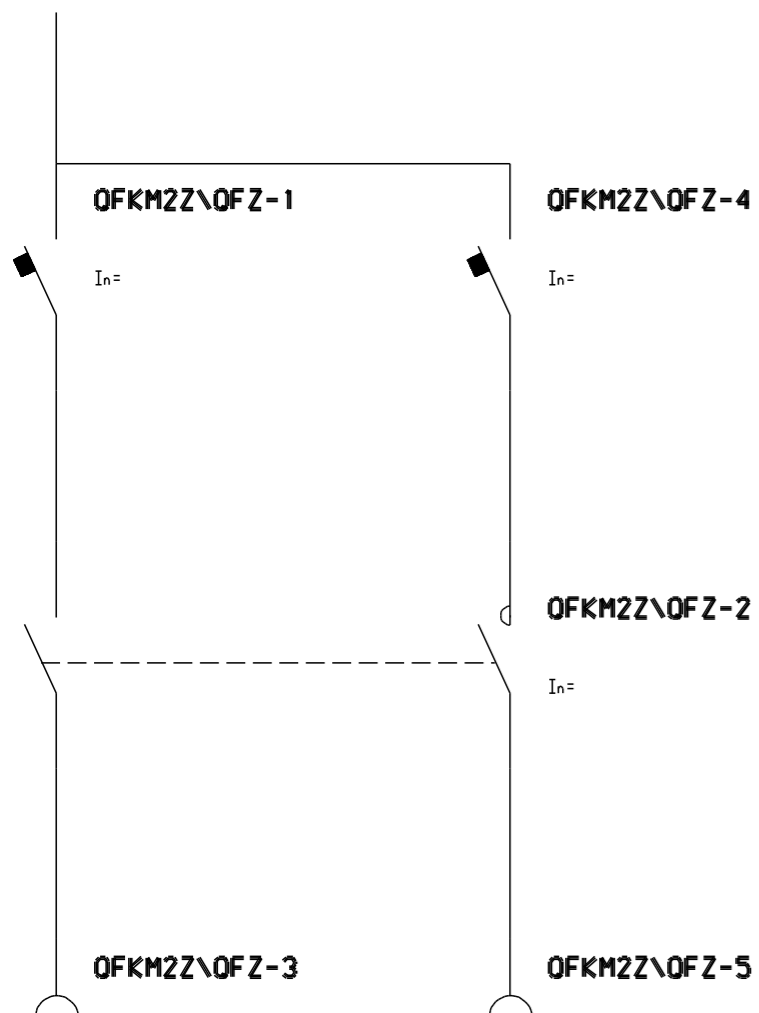

QFKMZZ\QFZ - 2 MODULY

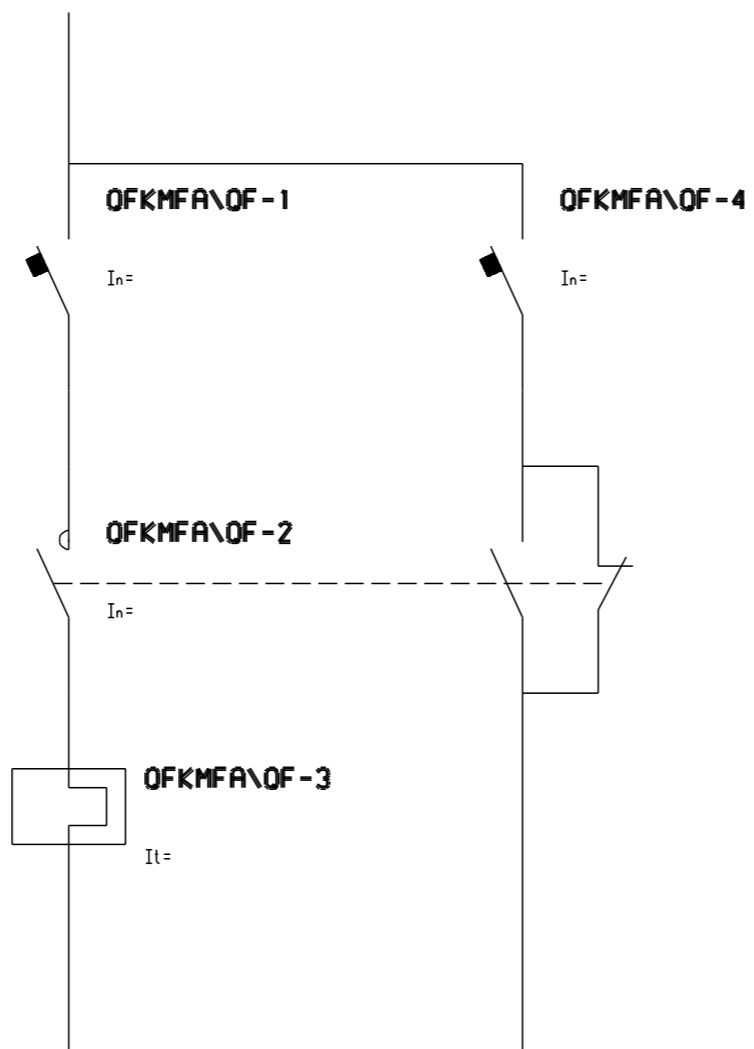

QFKMFA\QF - 2 MODULY

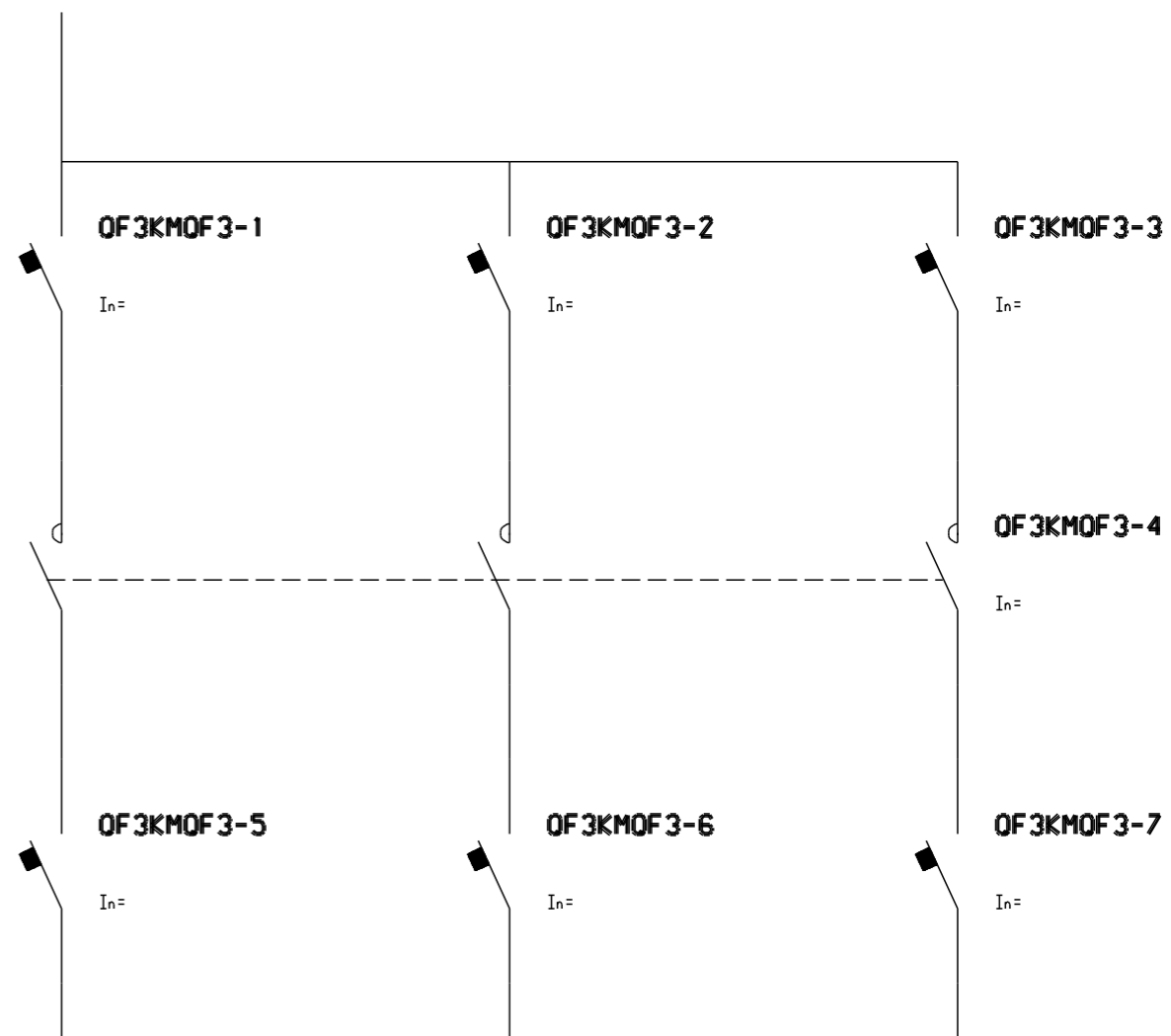

QF3KMOF3 - 3 MODULY

QFKM\QF2

QFKM\QF2

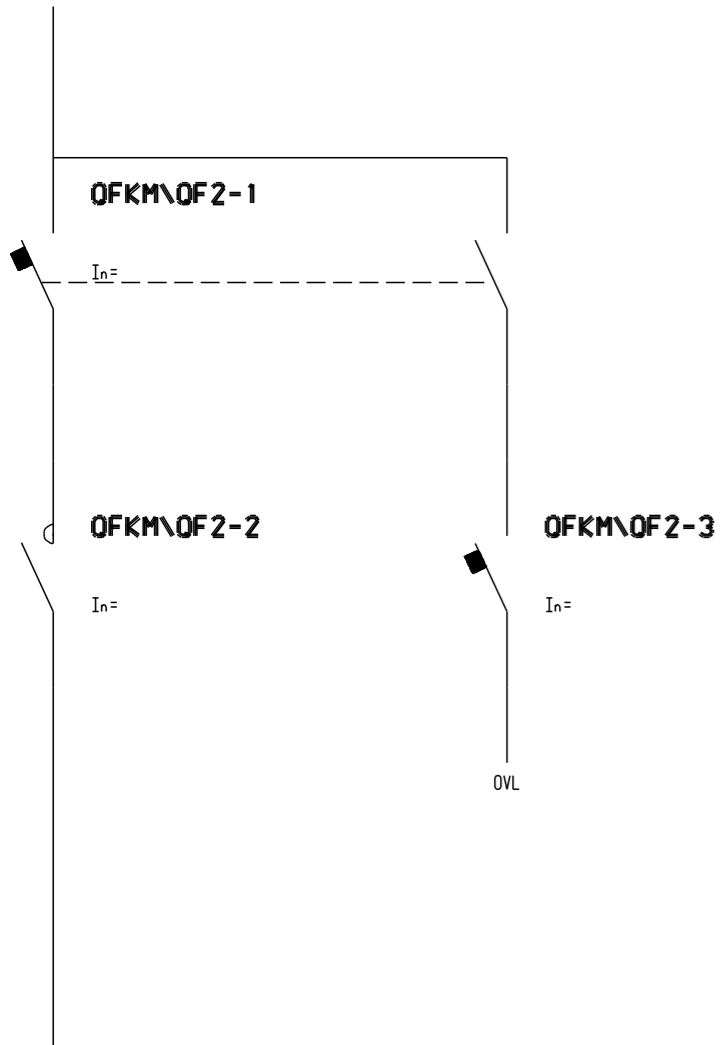

QFKM\QF - 2 MODULY

QFKM\QF1

QFKM\QF1

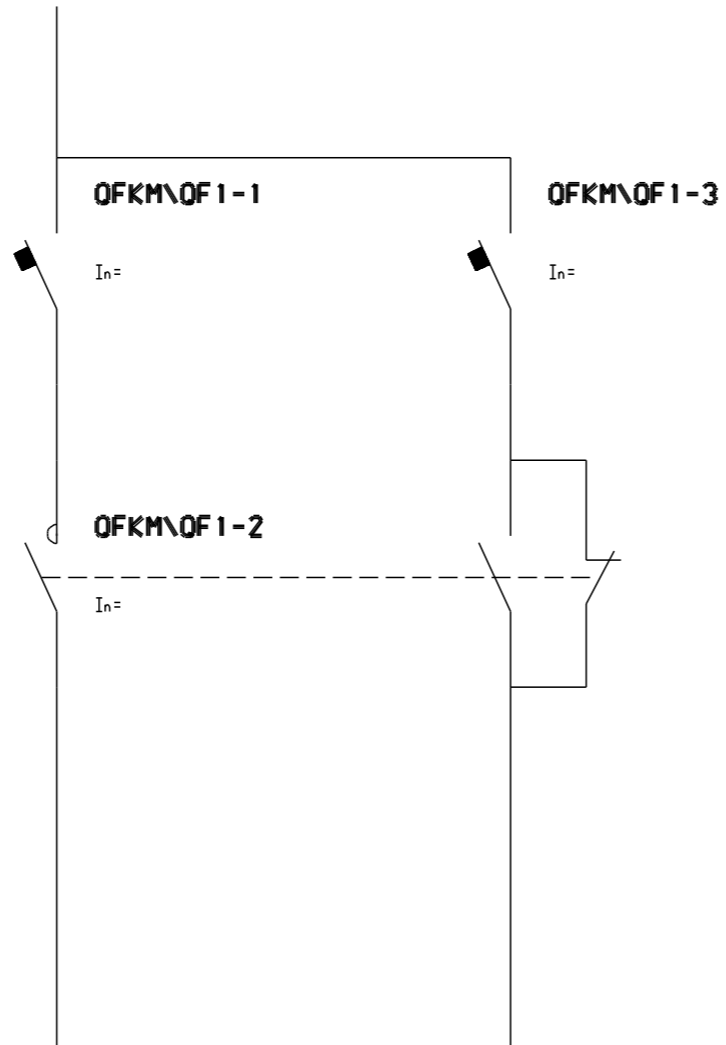

QFKM\QF1 - 2 MODULY

QFOVL

QFOVL

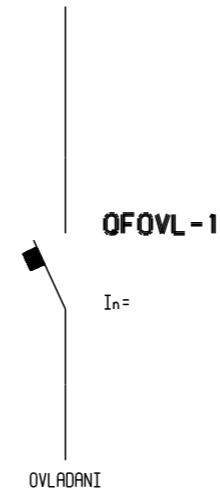

QFOF\Z

QFOF\Z

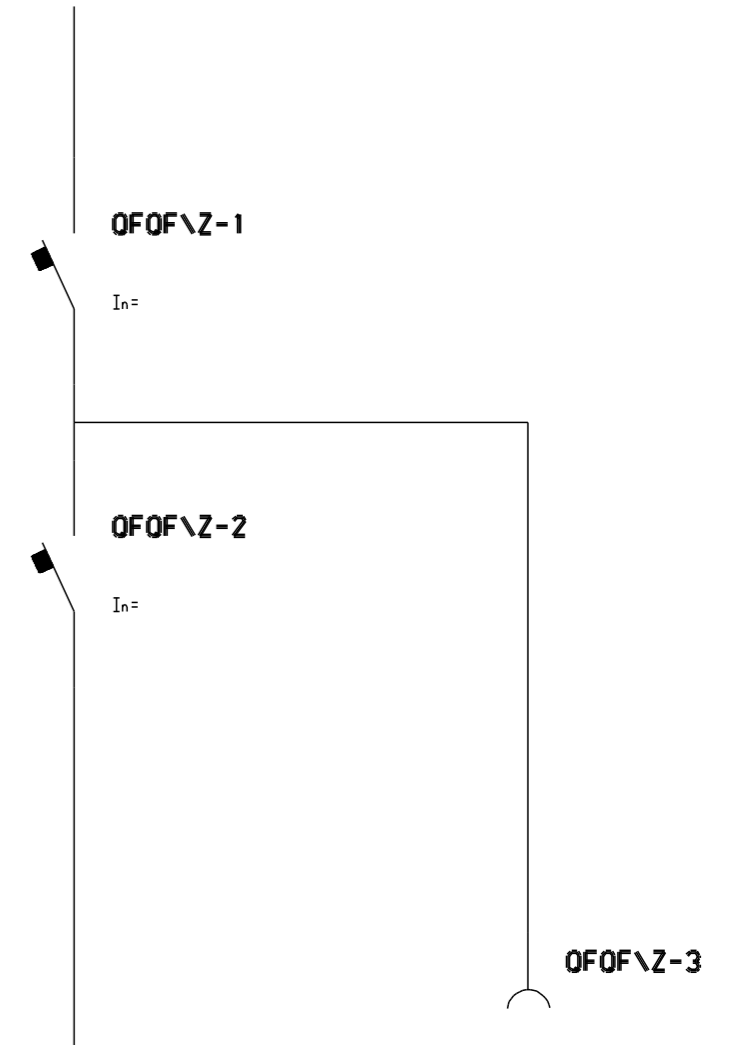

QFOF\Z - 2 MODULY

OF3KM1

OF3KM1

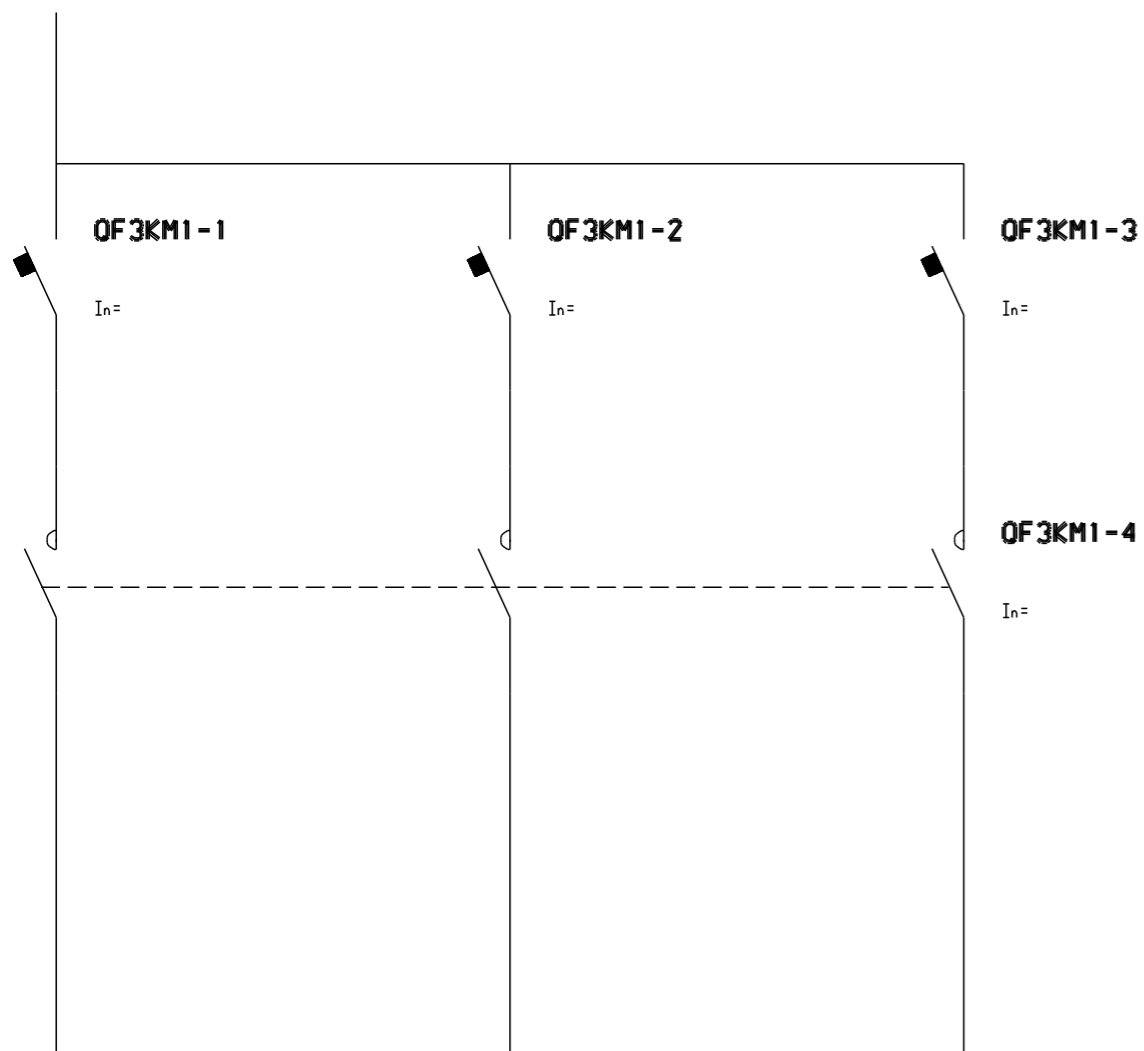

OF3KM1 - 3 MODULY

PR<OF>\FU

PR<OF>\FU

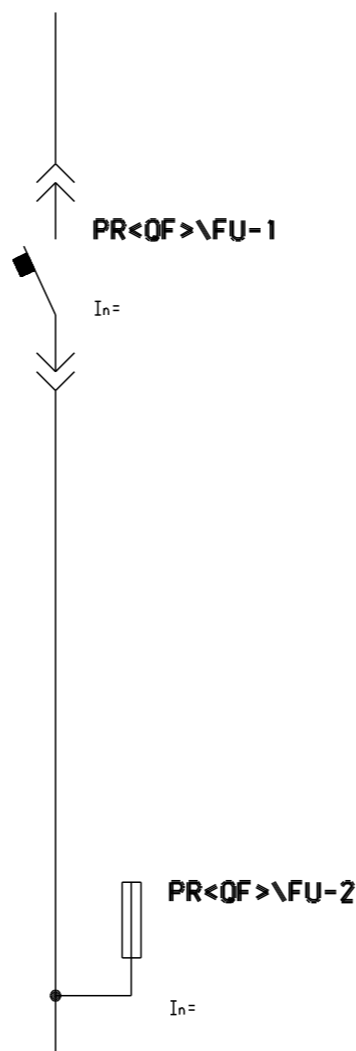

OFKMOVL

OFKMOVL

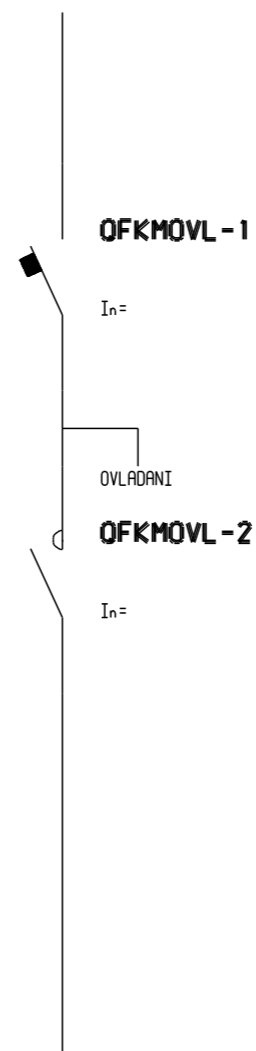

OFKA

OFKA

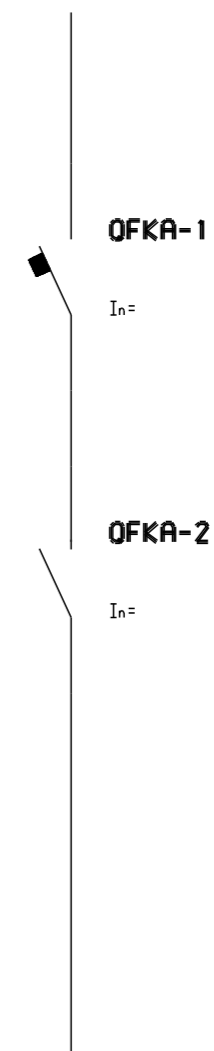

PROFTA1\FU

PROFTA1\FU

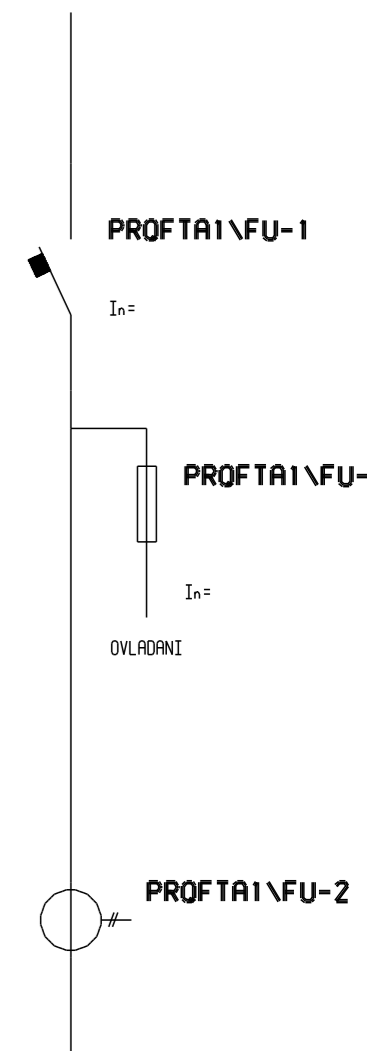

OFNEZAP
OFNEZAP

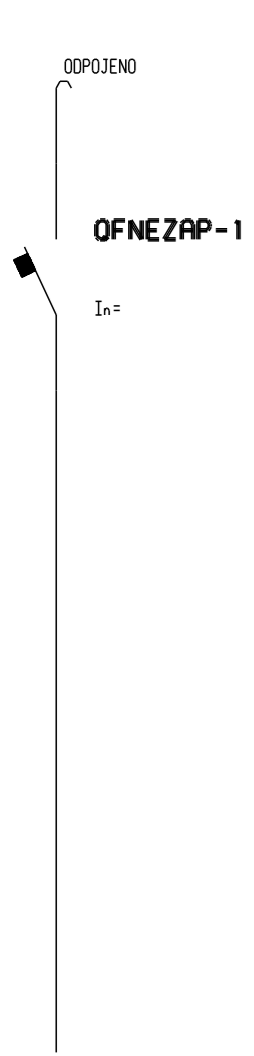

PROFTA1
PROFTA1

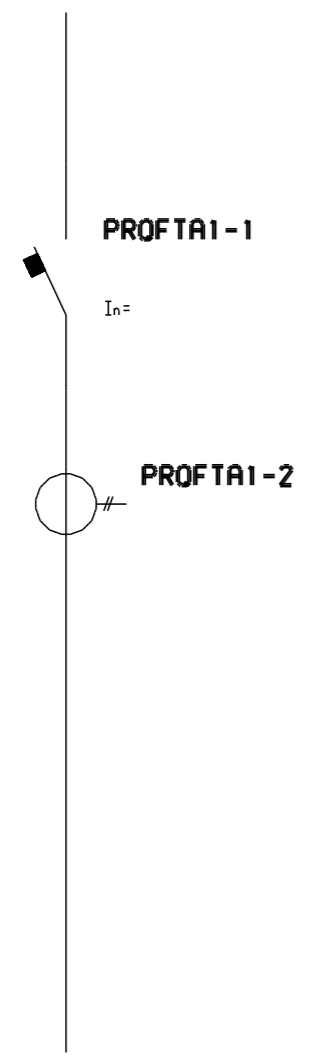

OFOM\Z
OFOM\Z

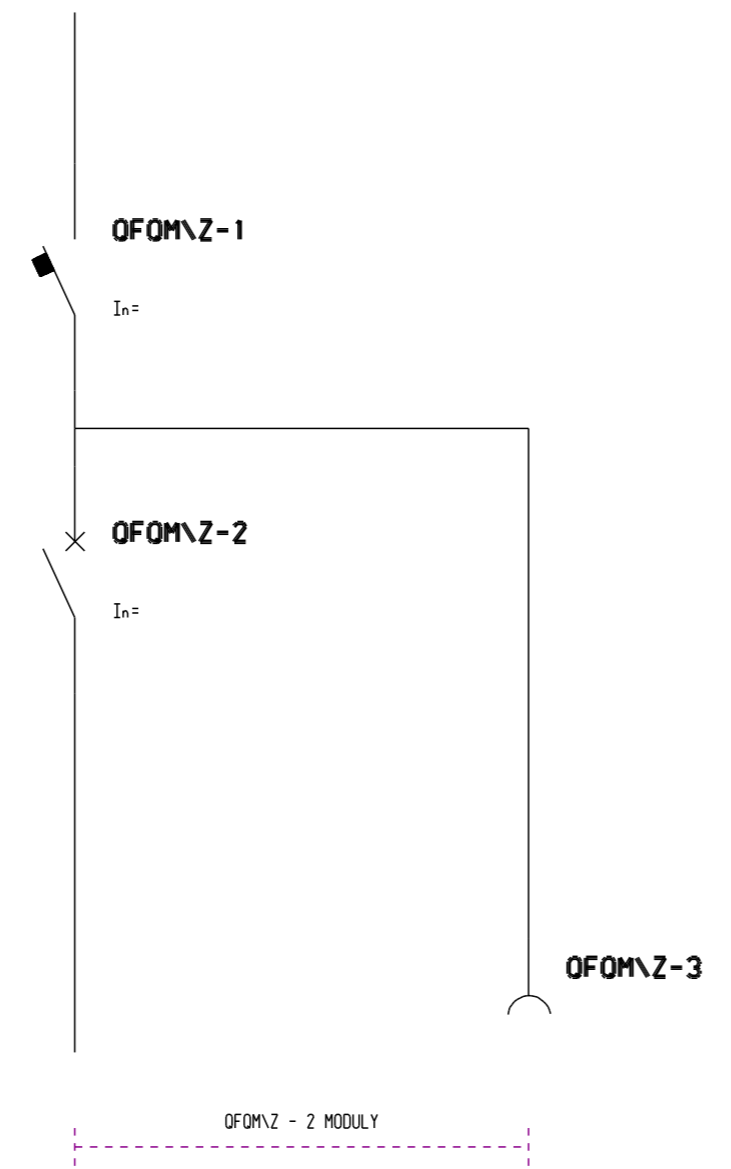

OFKMR
OFKMR

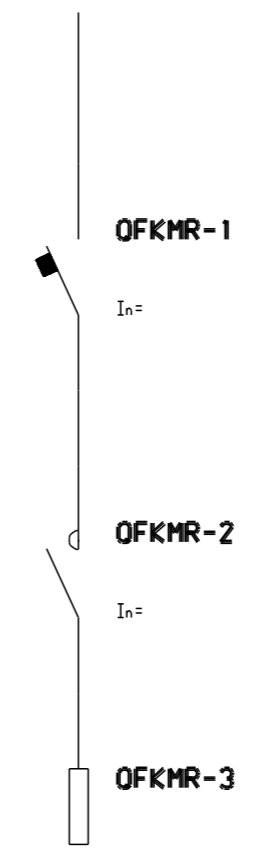

OFKM\X
OFKM\X

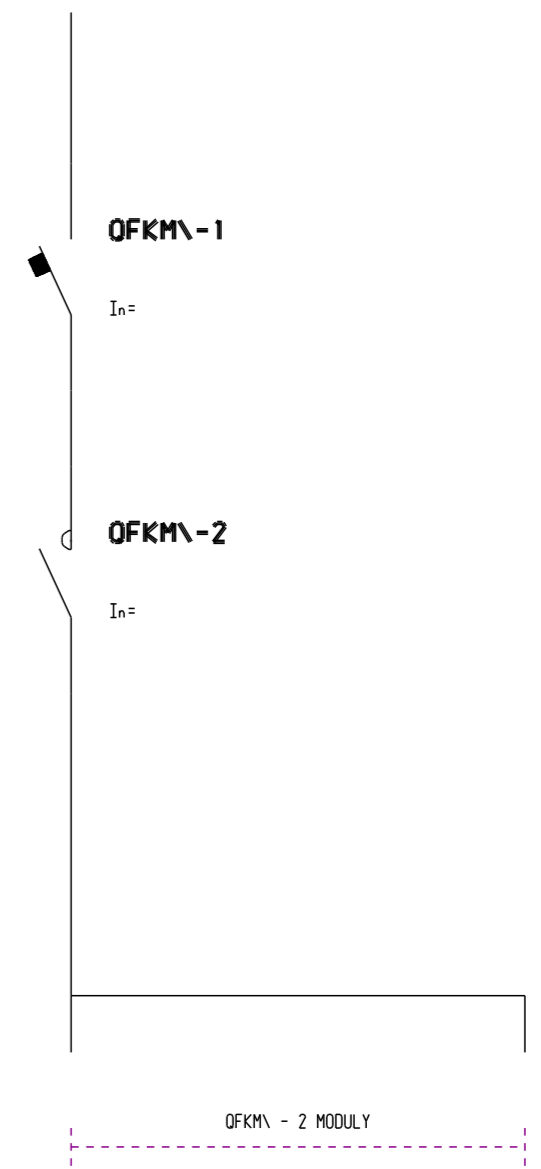

PRFIOF

OFOFIKM

OFKAOB

OFKAOBOM

OFKAOBKM

OFKAOVL

FAFI

PRFIOF

OFOFIKM

OFKAOB

OFKAOBOM

OFKAOBKM

OFKAOVL

FAFI

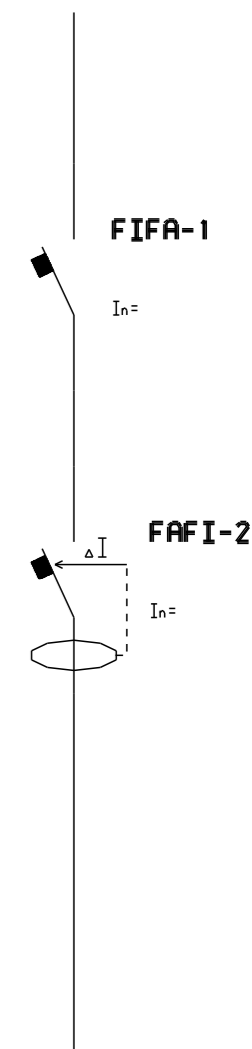
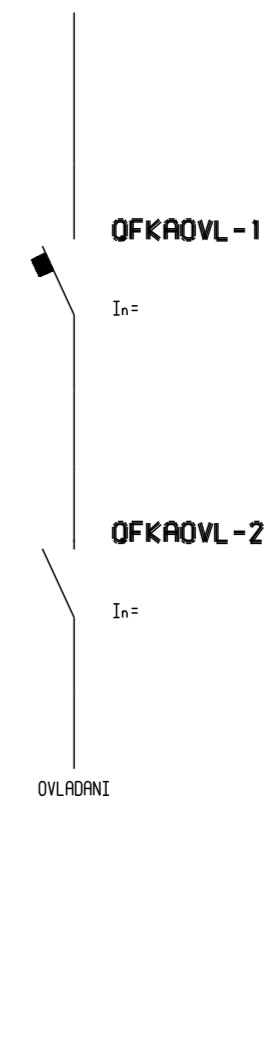
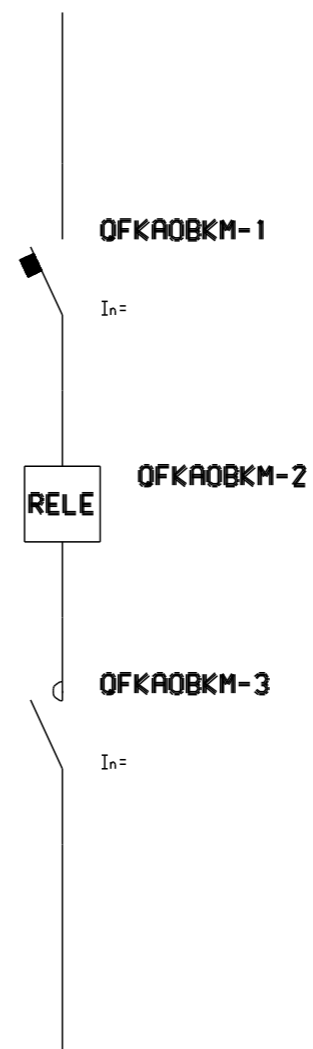
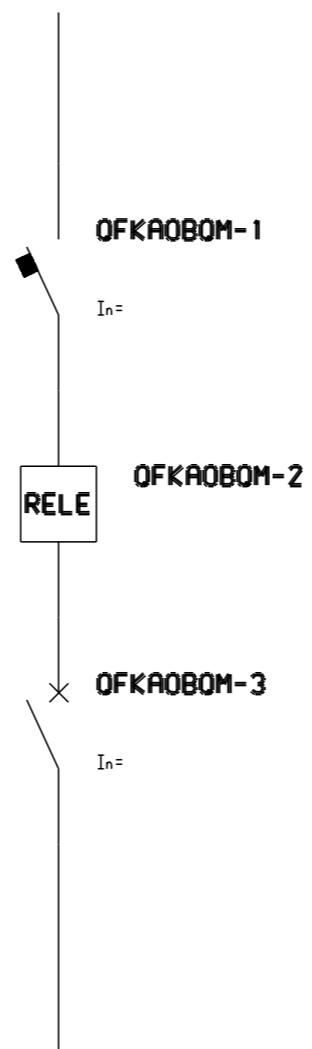
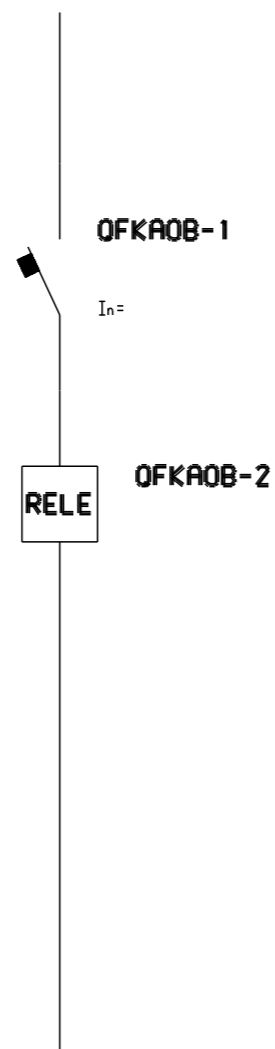
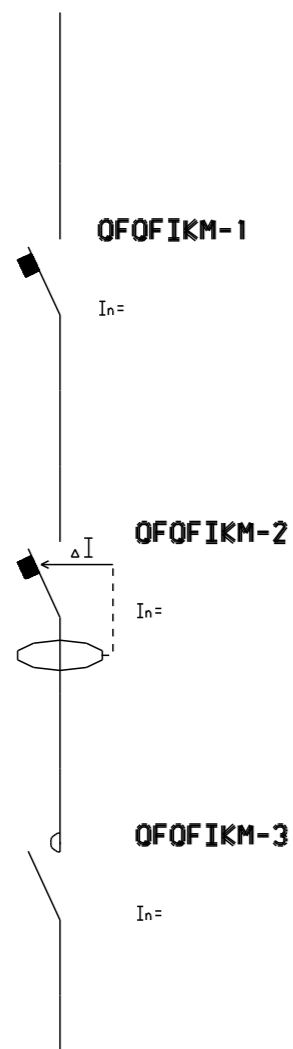
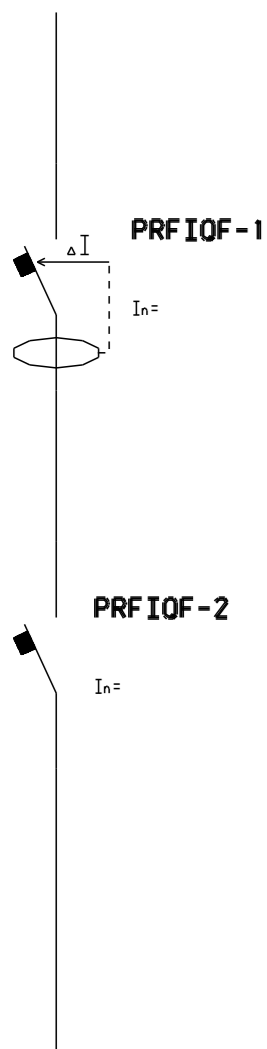

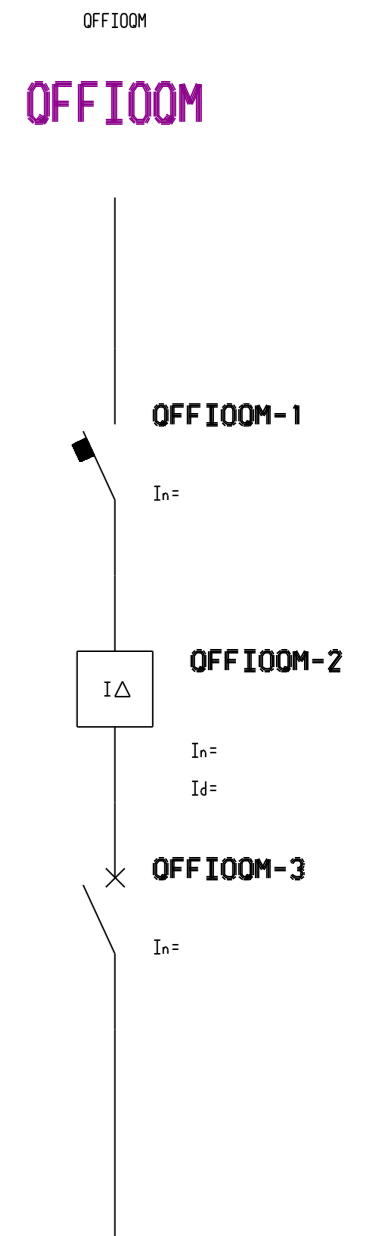
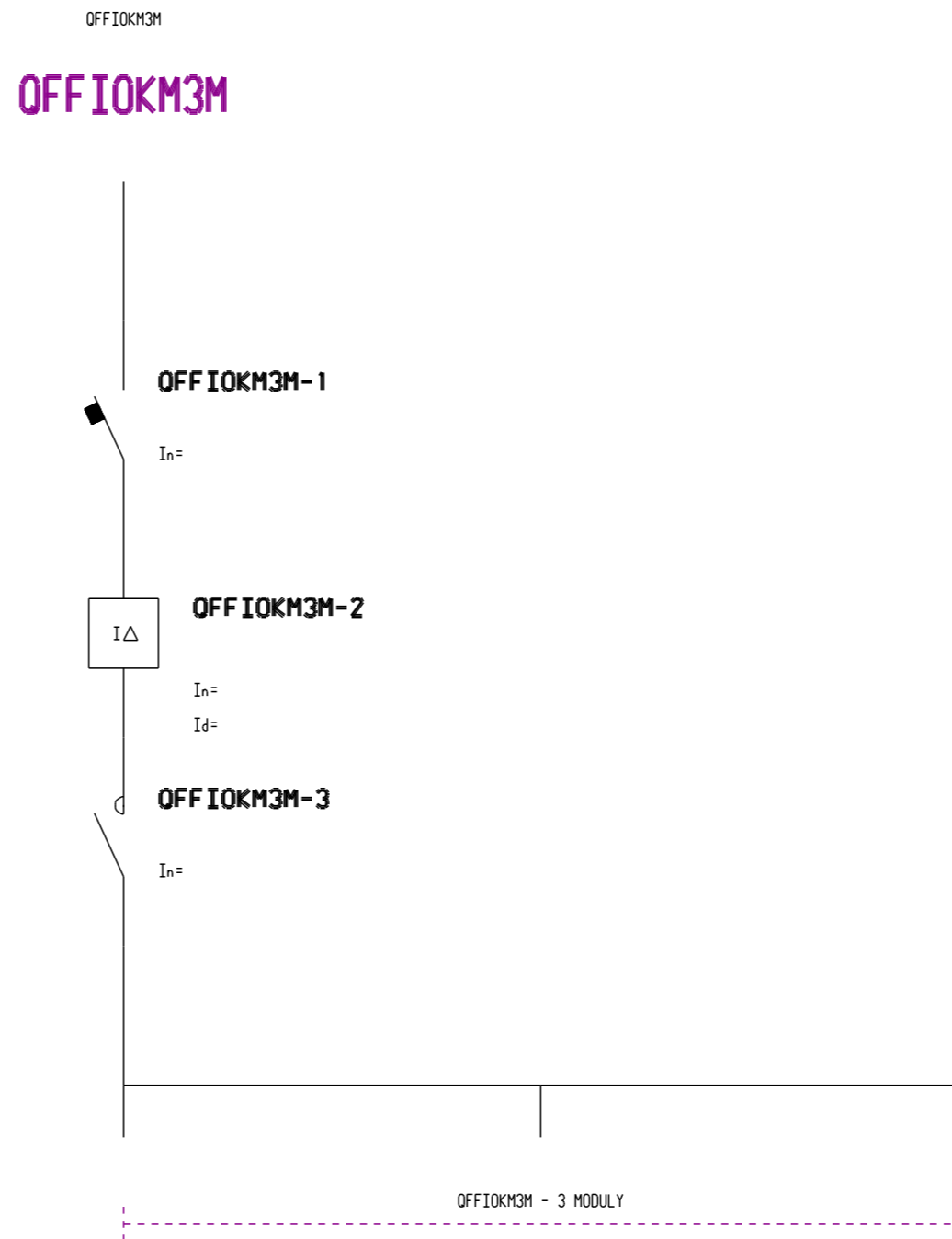
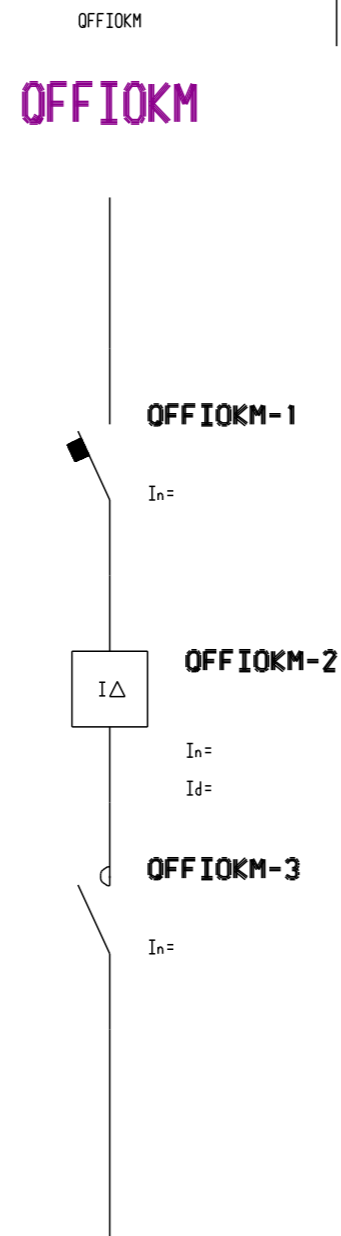
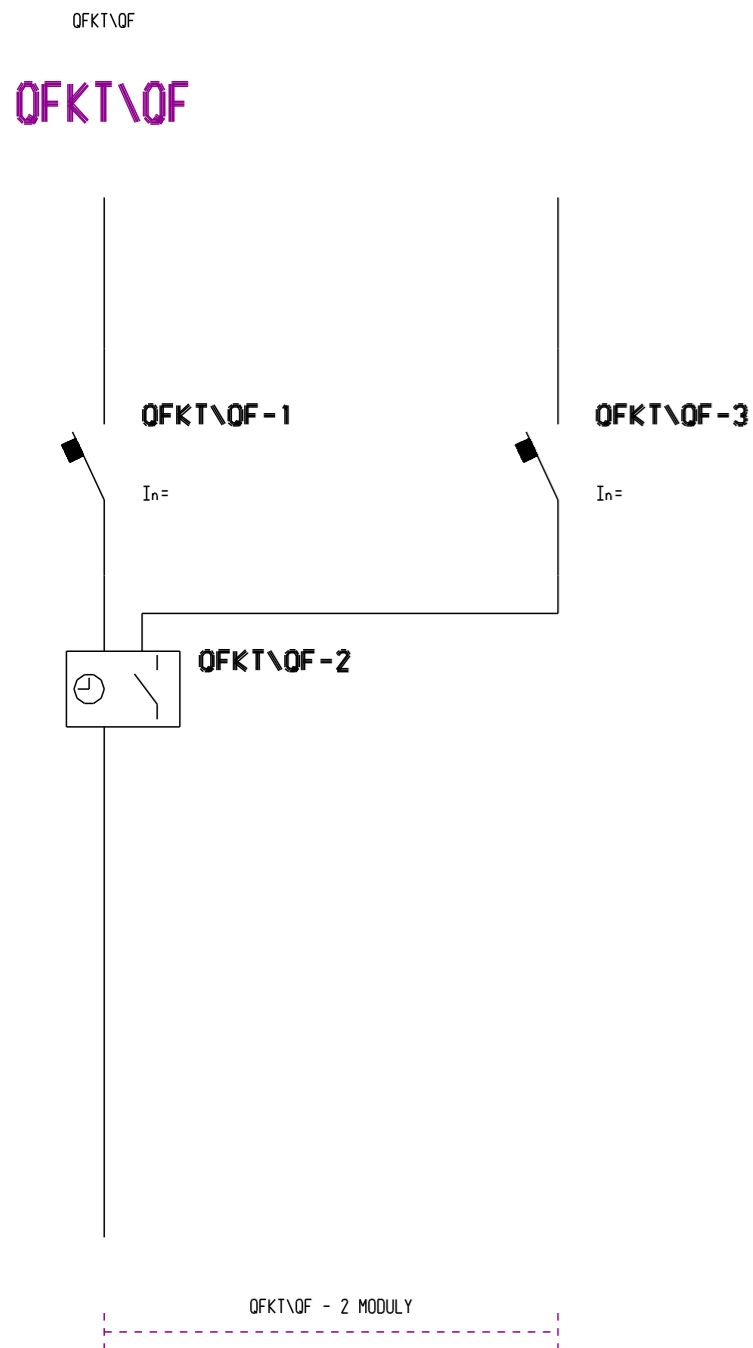

PRTAQ\FU\QF

PRTAQ\FU\QF

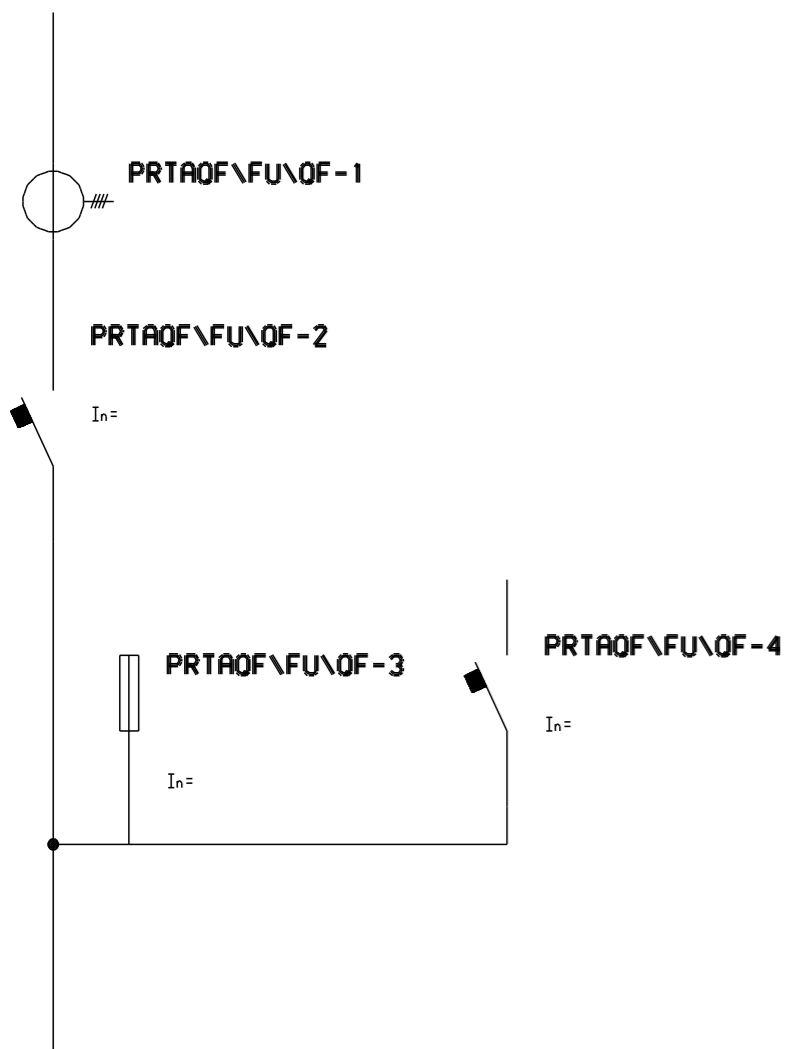

PRTAQ\FU\QF - 2 MODULY

QFKMVZ\QF

QFKMVZ\QF

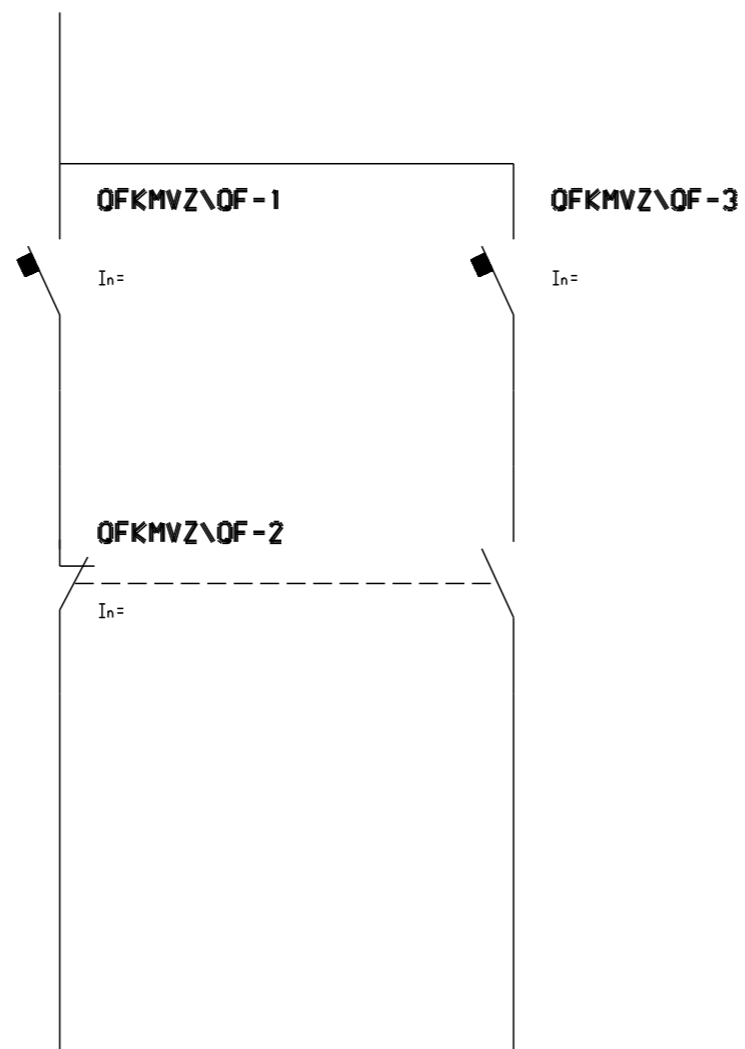

QFKMZVSYMBL

QFKMZVSYMBL

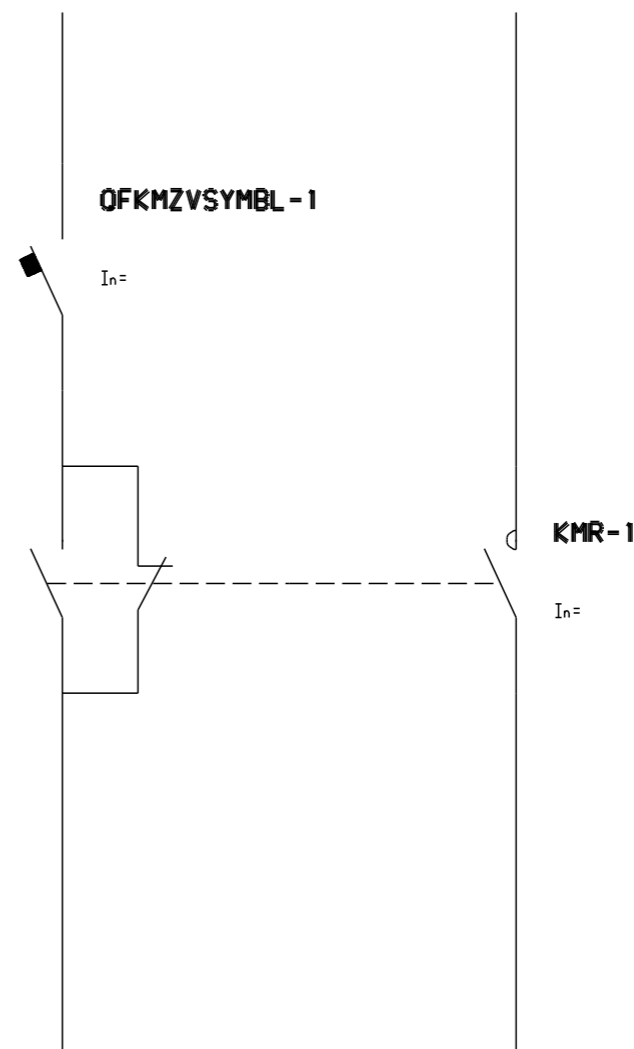

KMR

KMR

PROF\FU\FV

PROF\FU\FV

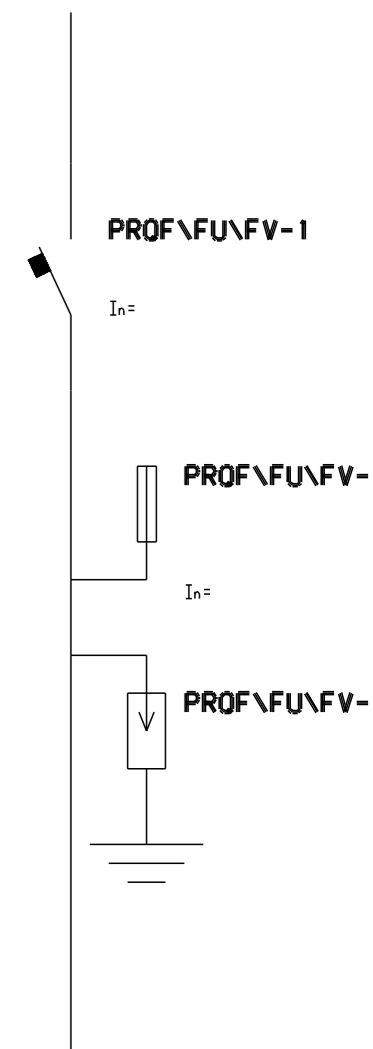

QFKMNG\TZKM\TZK

QFKMNG\TZKM\TZKM\KM

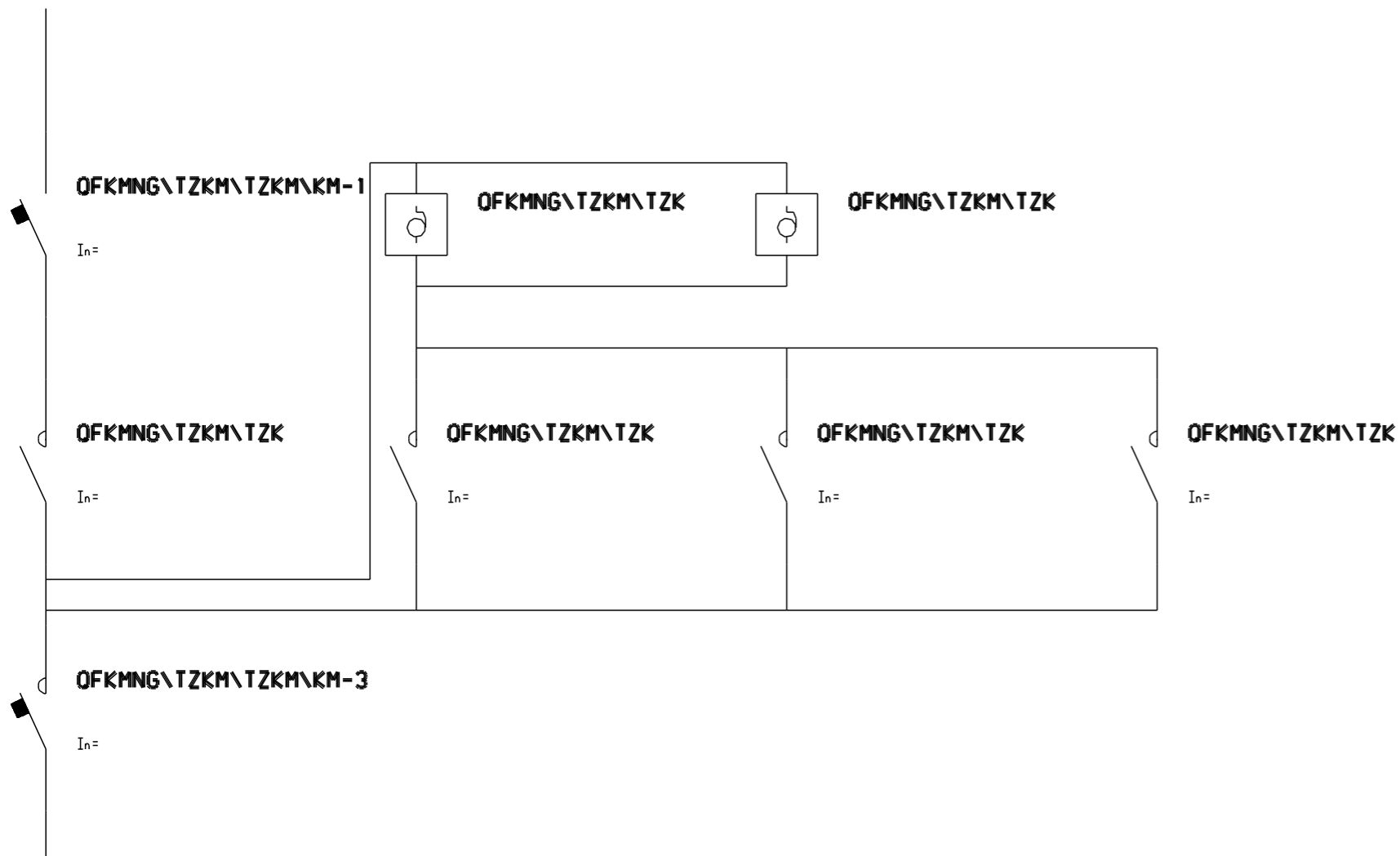

QFKMNG\TZKM\TZKM\KM - 4 MODULY

QFQMOBP

QFQMOBP

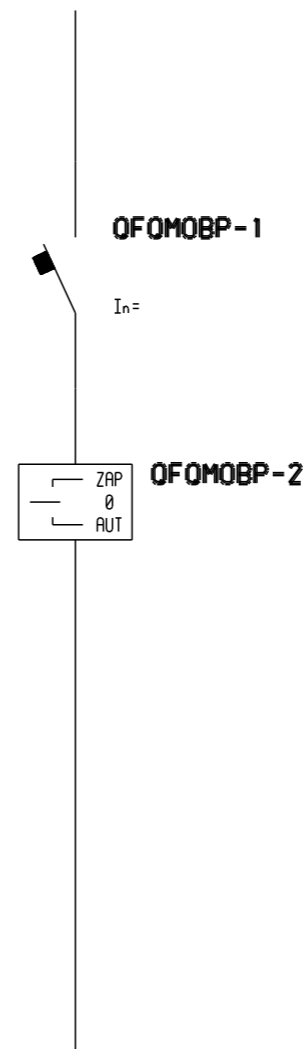

PROF\FV

PROF\FV

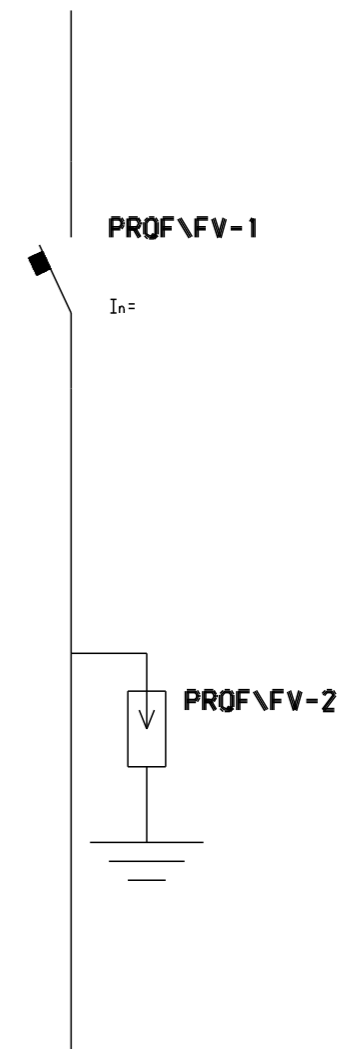

QFTRKX

QFTRKX

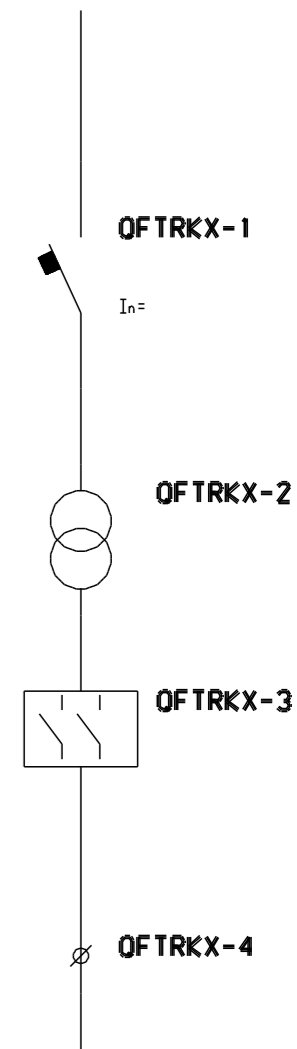

PROF\FUFU

OF2KM1

PROF\FU2

OFKM\FV

OFKAMR

PROF\FUFU

OF2KM1

PROF\FU2

OFKM\FV

OFKAMR

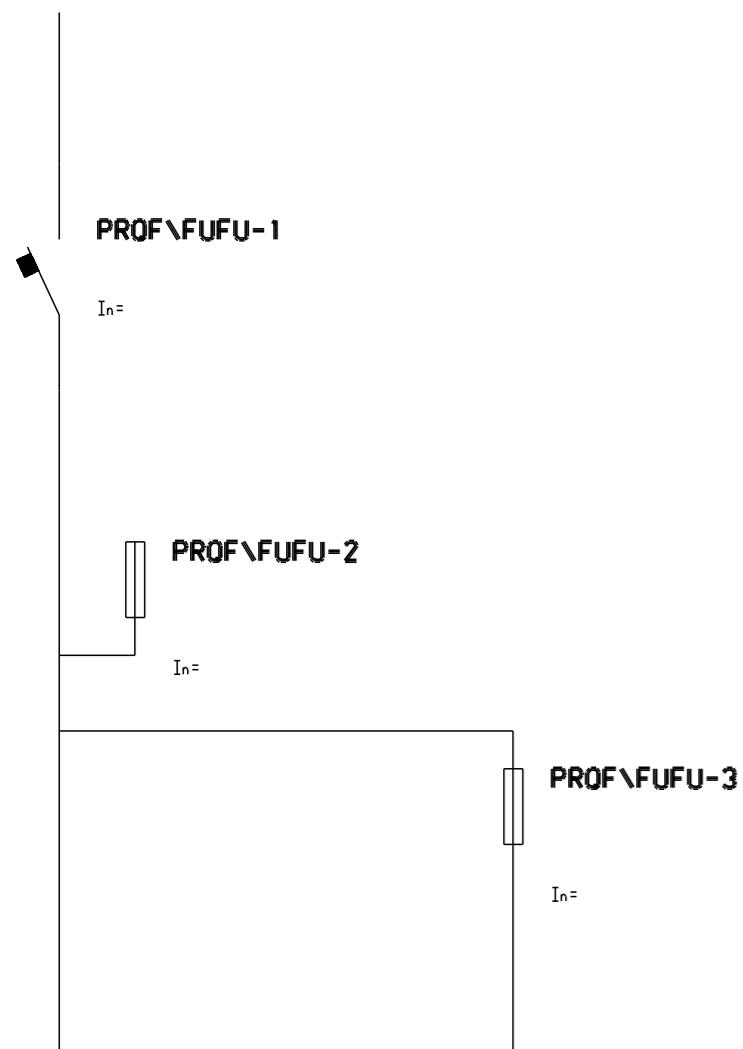

PROF\FUFU - 2 MODULY

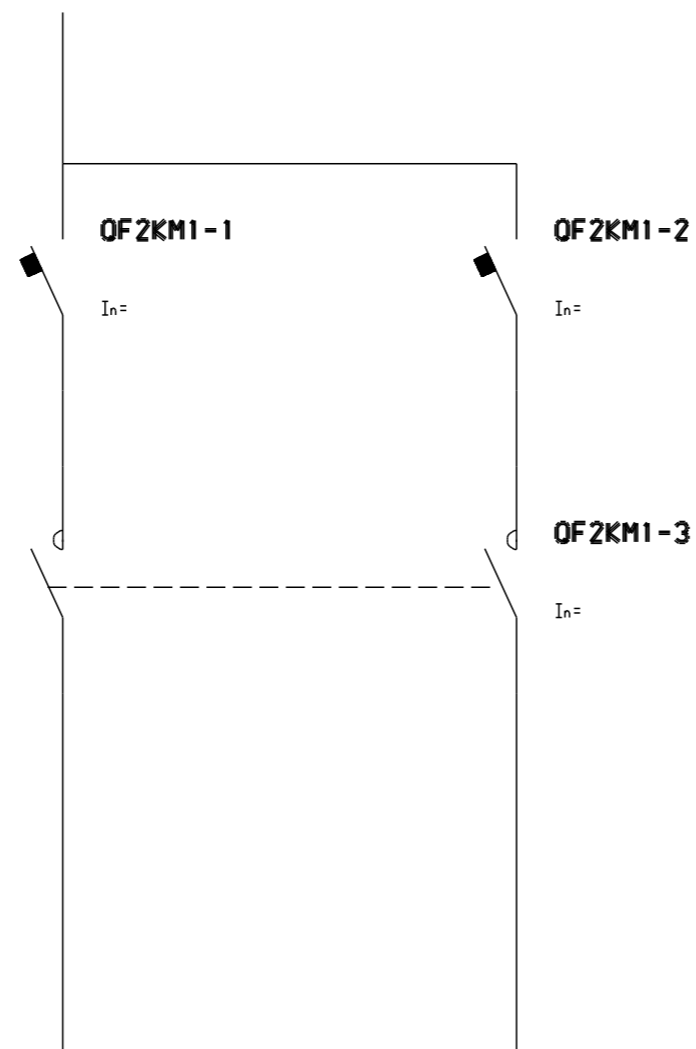

OF2KM1 - 2 MODULY

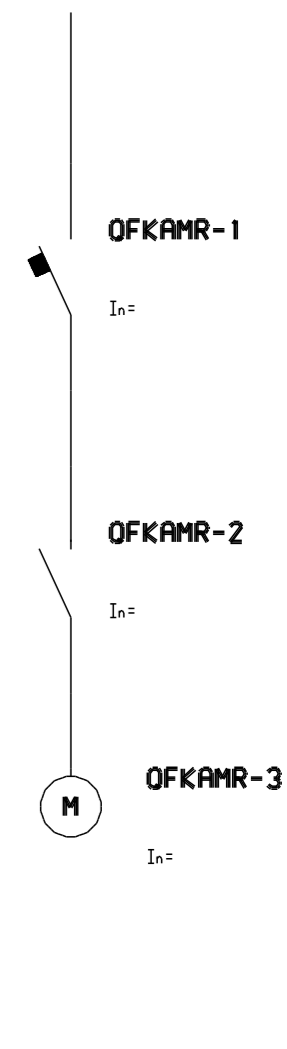
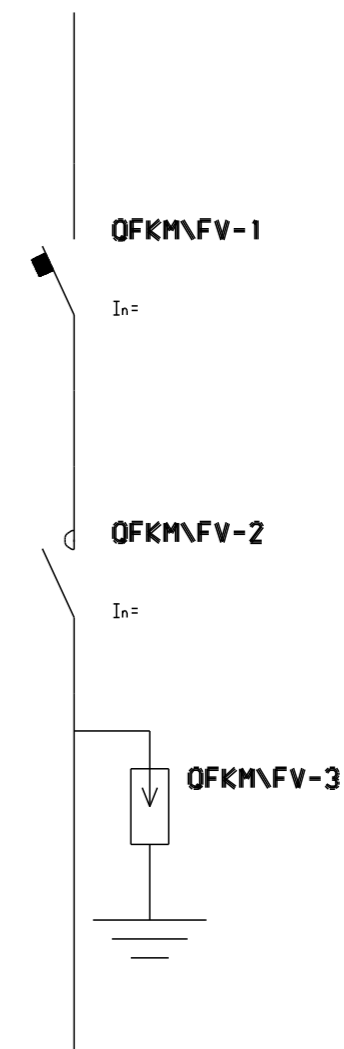
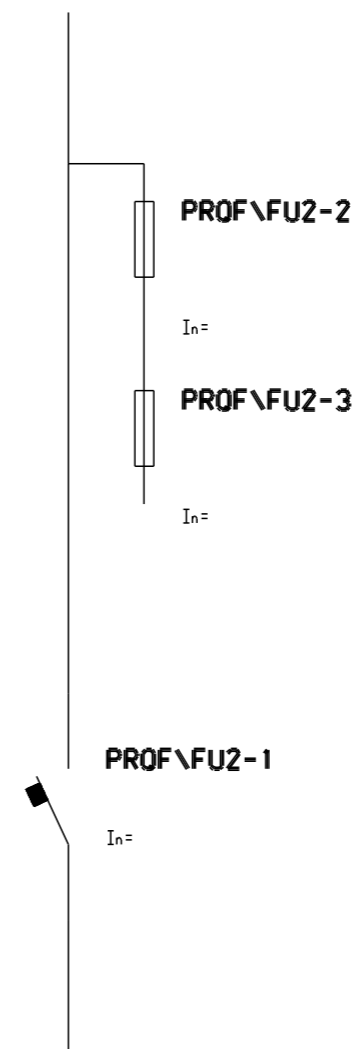

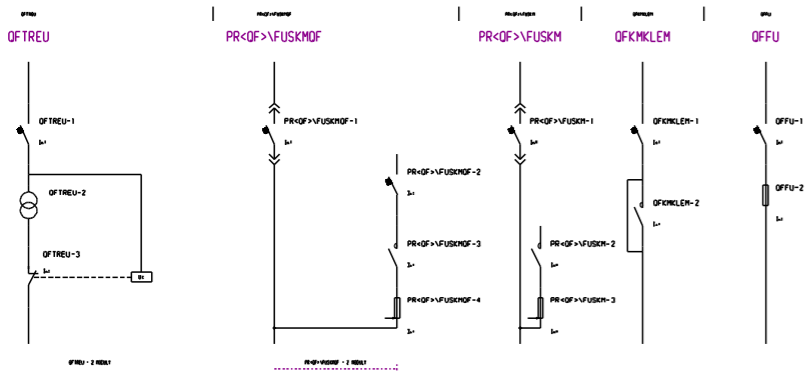

OF\Z

OF\Z

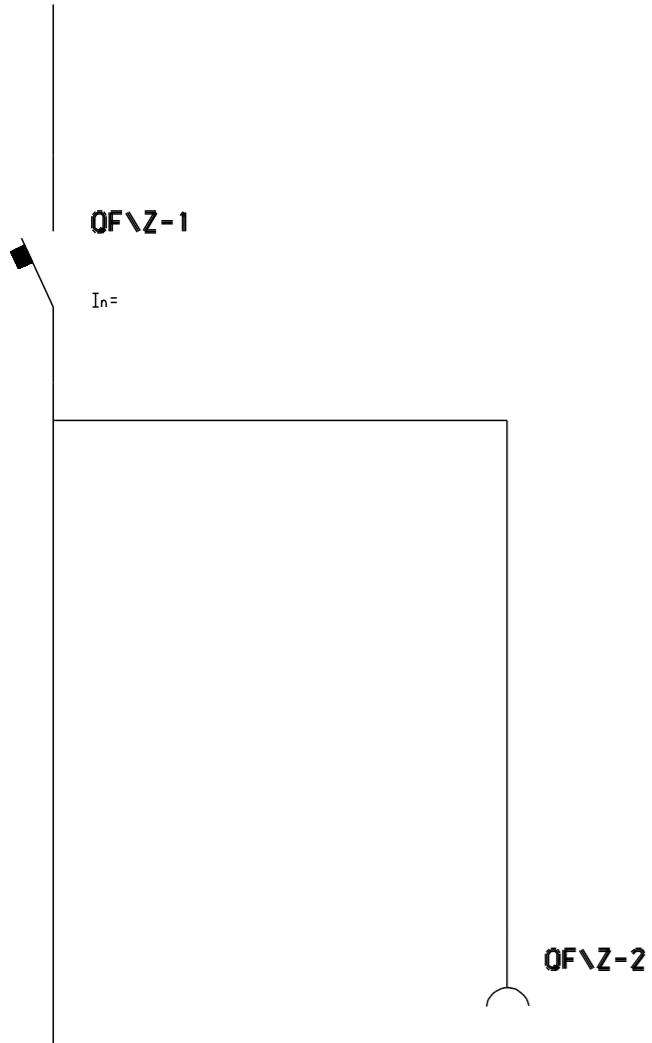

OF3

OF3

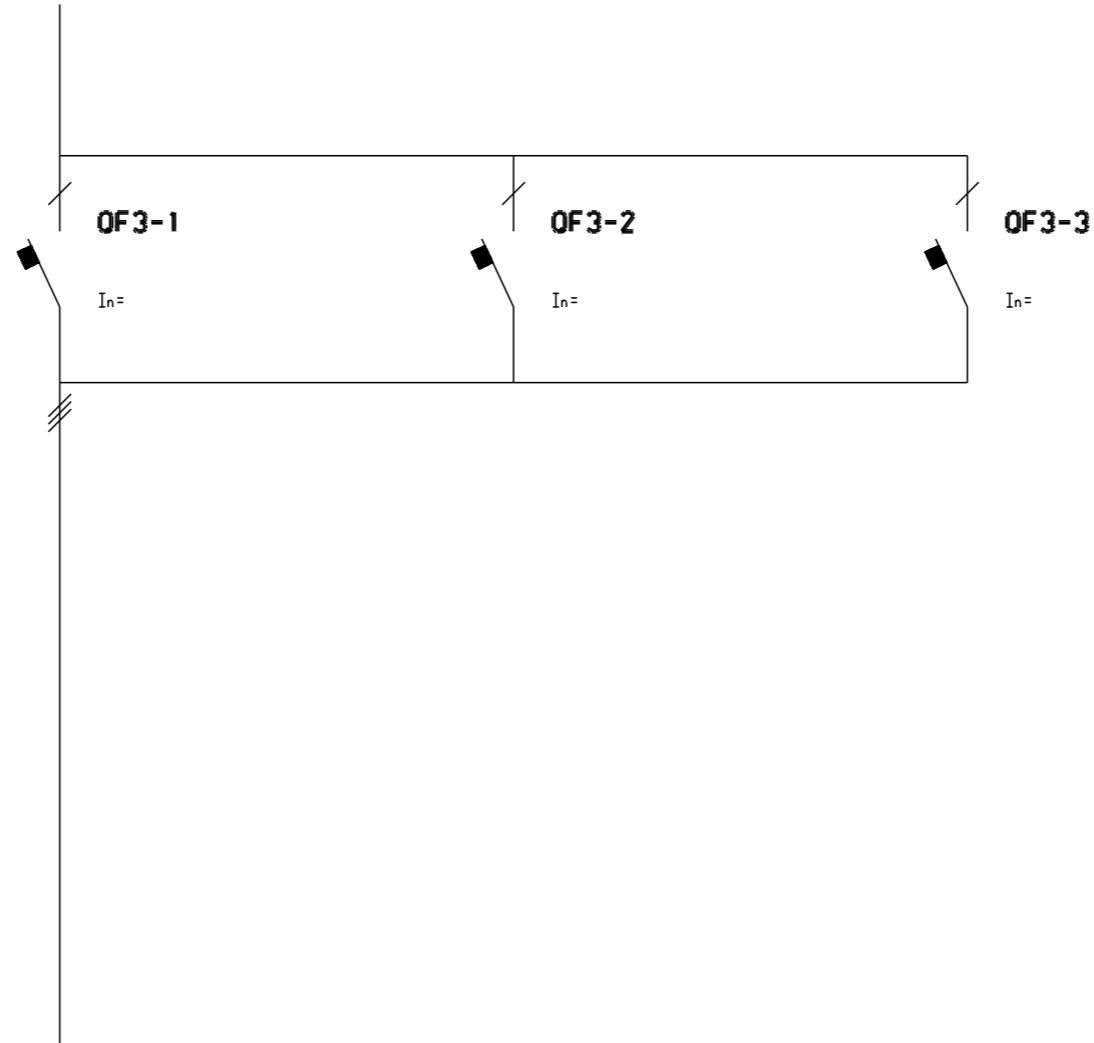

PR<OF>\FUS_M

PR<OF>\FUS_M

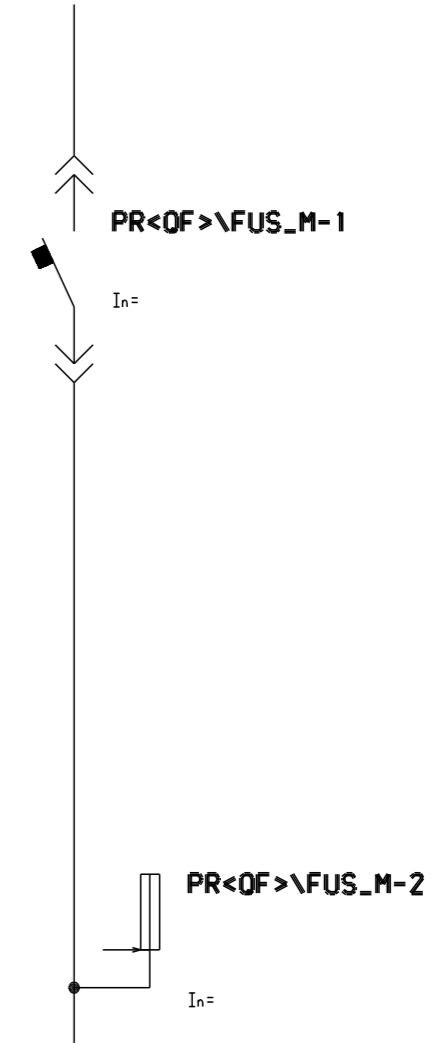

OFKAM

OFKAM

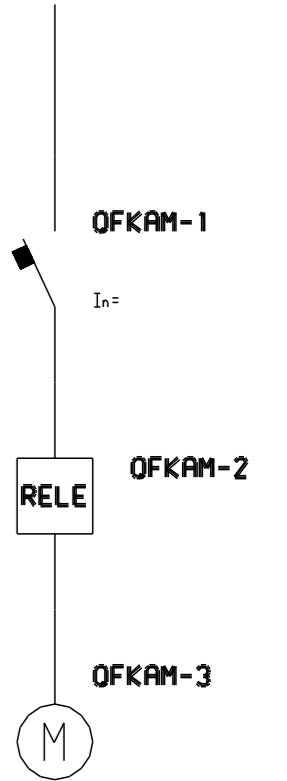

PR<OF>\OSF2

PR<OF>\OSF2

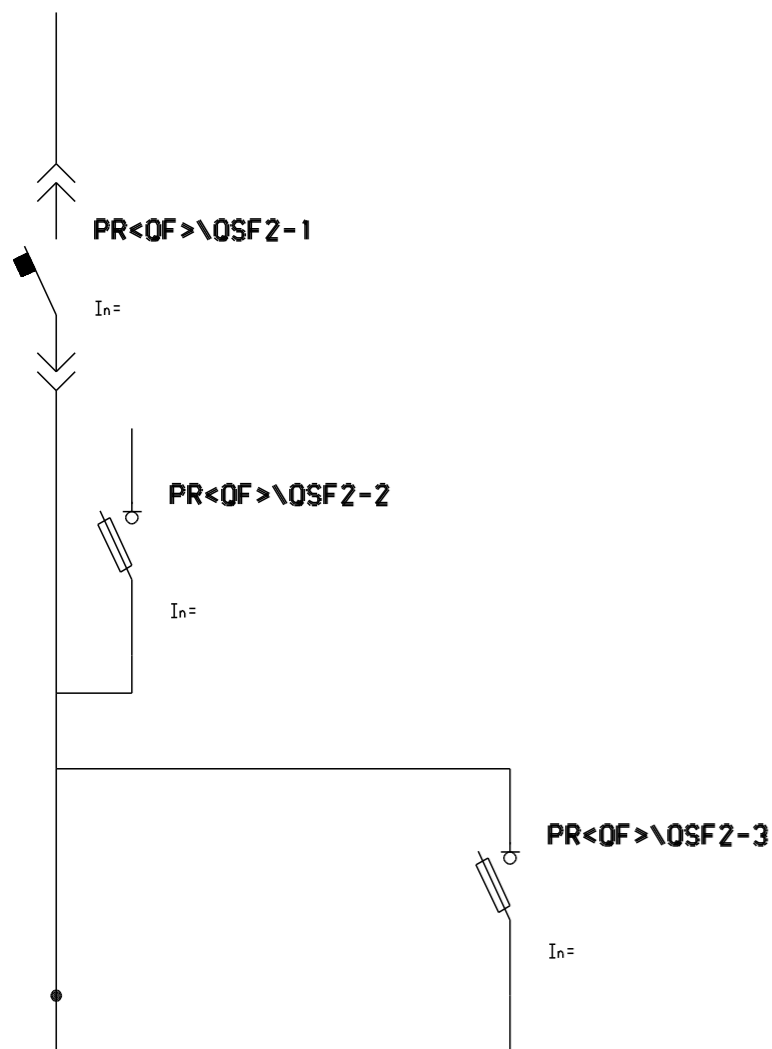

PR<OF>\OSF2 - 2 MODULY

OFKMF44

OFKMF44

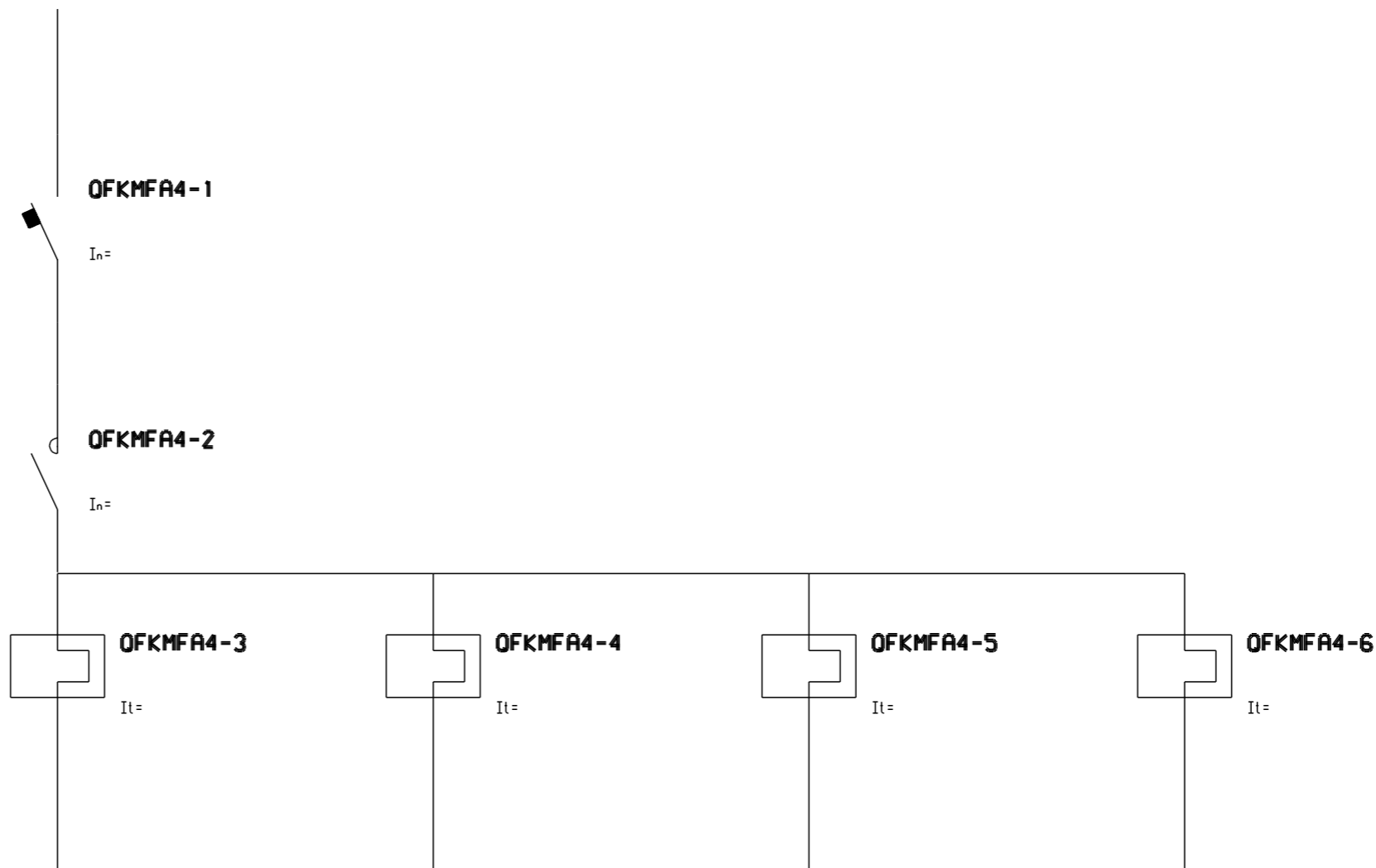

OFKMF44 - 4 MODULY

OFFMX

OFFMX

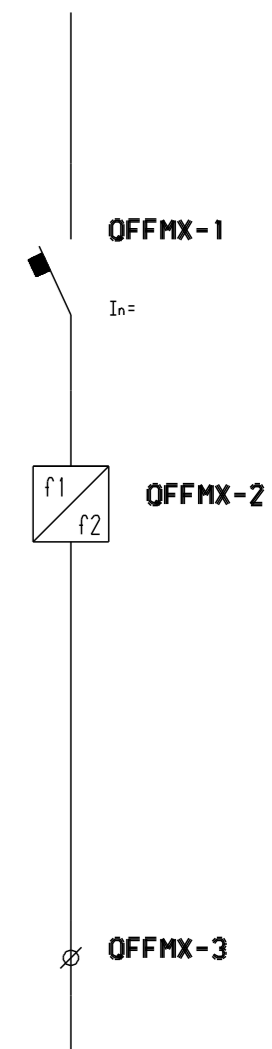

OFKMFA3

OFKMFA4

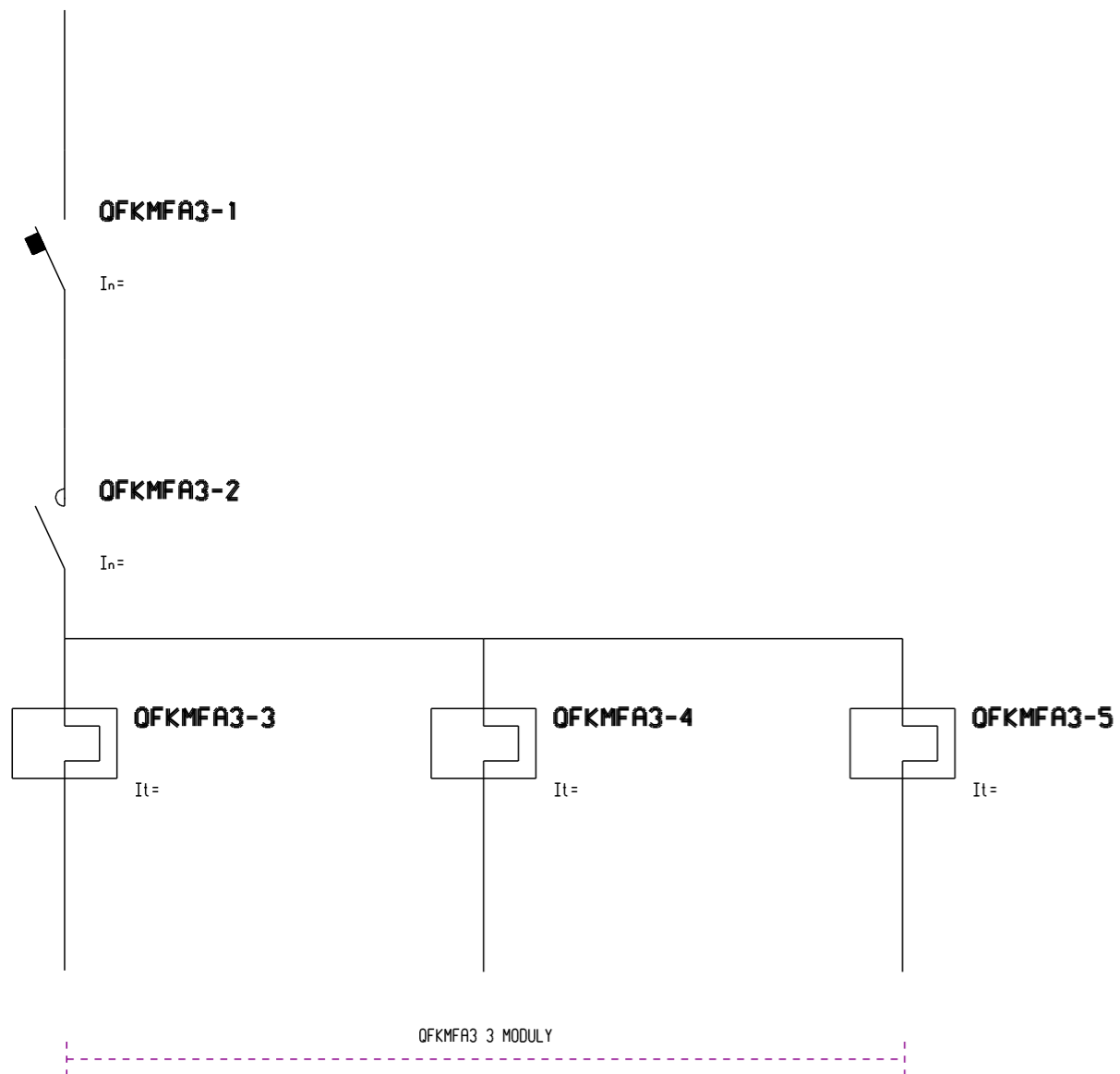

OSFOVL

OSFOVL

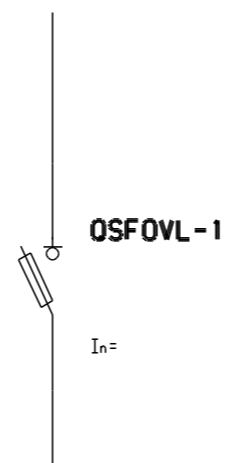

OF\OF2

OF\OF2

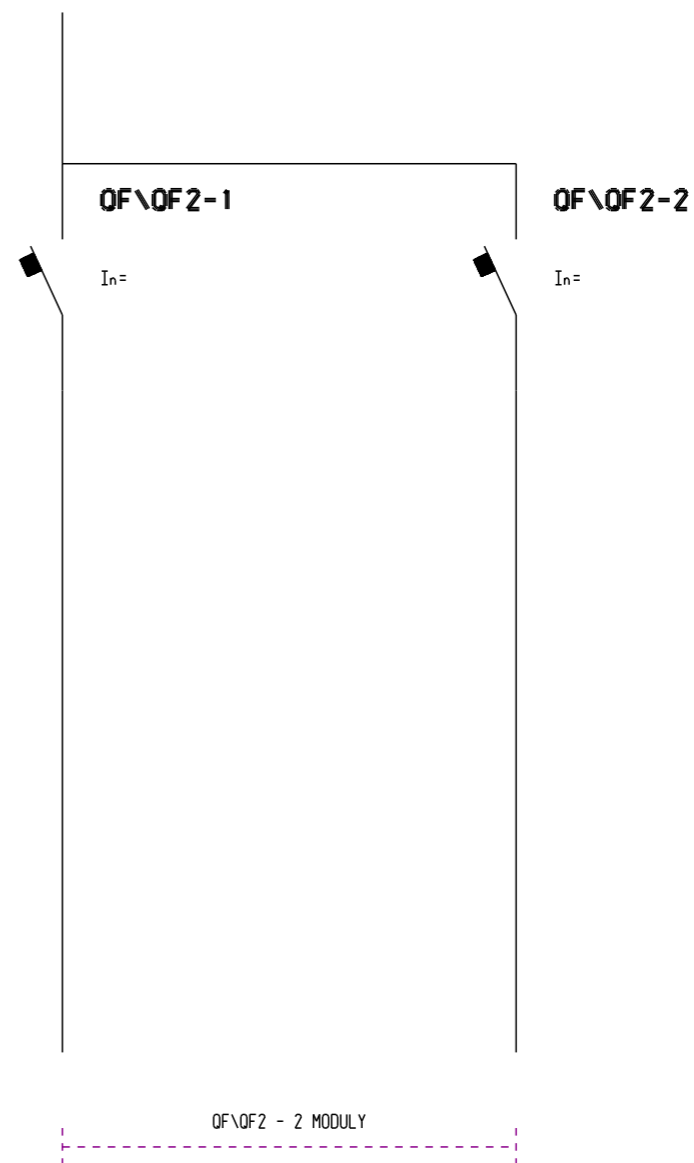

PROFX\OSF\OSFFV

PROFX\OSF\OSFFV

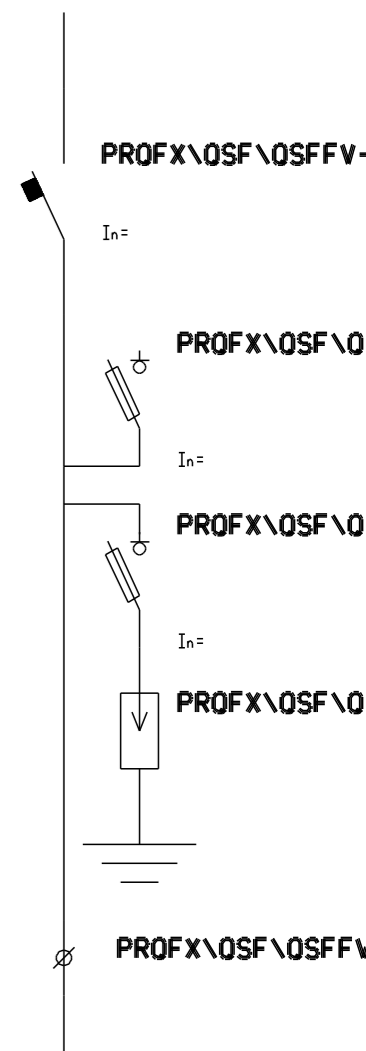

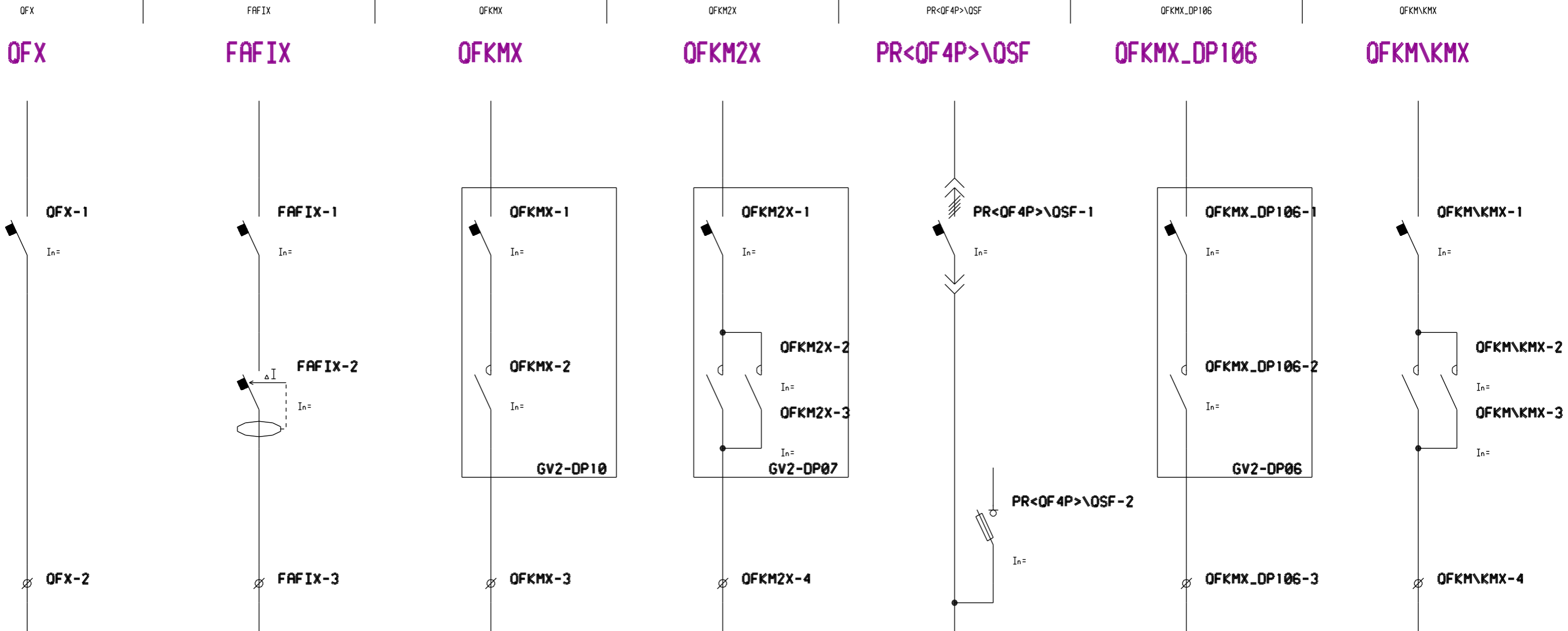

QFKMX_DP108

QFKAOBX

QFKMX1

QFKAOBX1

QFOS

QF\FV

QFNG2X

QFKMX_DP108

QFKAOBX

QFKMX1

QFKAOBX1

QFOS

QF\FV

QFNG2X

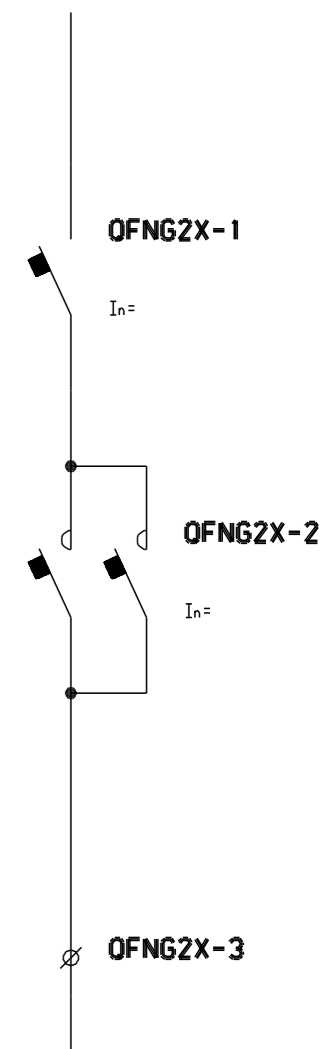
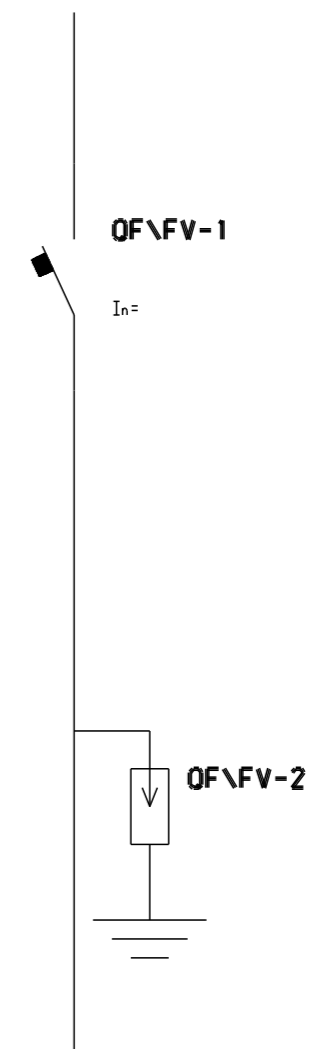
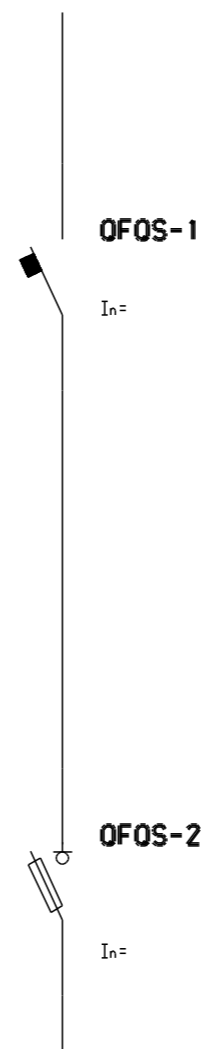
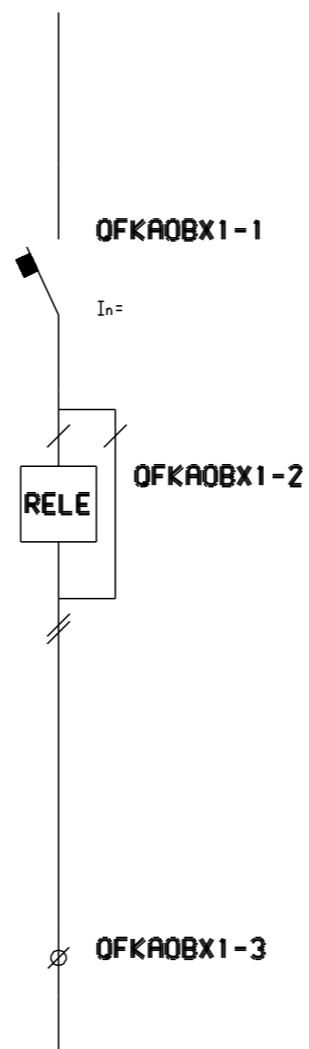
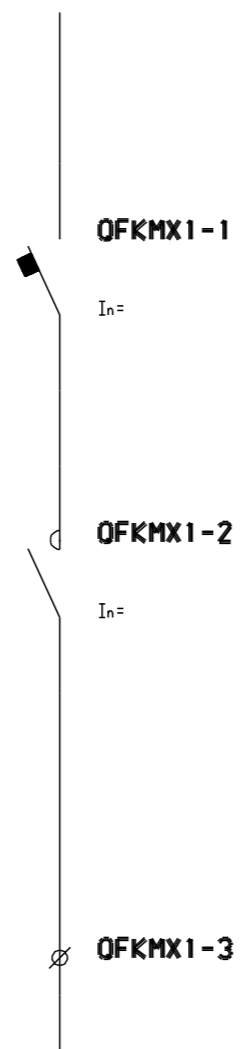
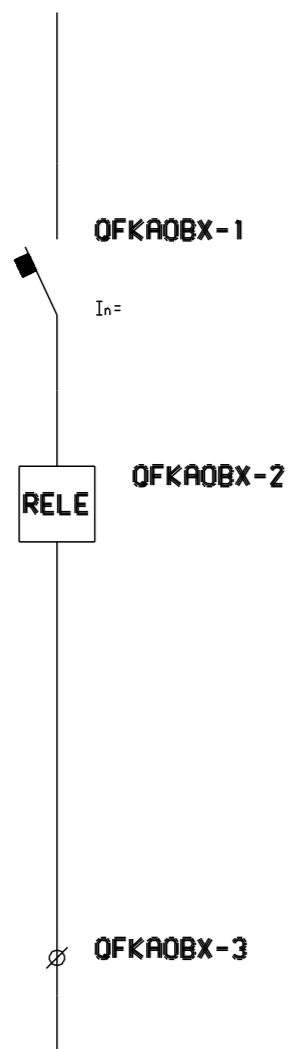
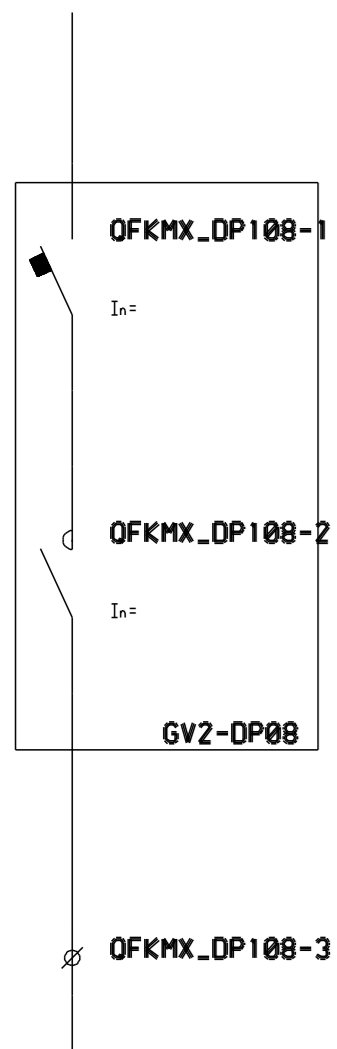

OFOSX

OFQFX

OF4KM8

PROFX

OFOSX

OFQFX

OF 4KM8

PROFX

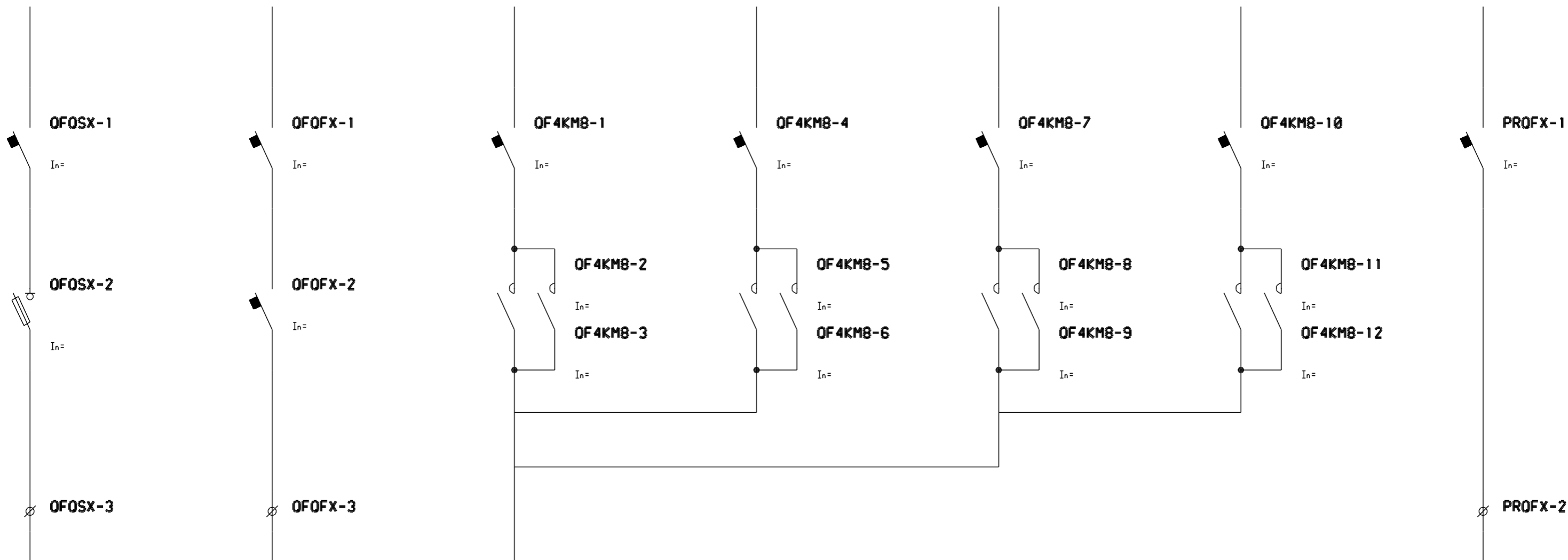

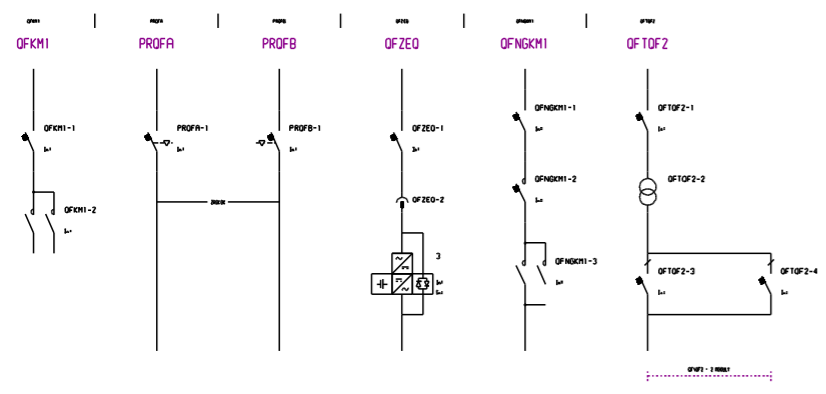

ZALOZENO DNE 12.2.2015
 ARCH.CISLO 4700-X-000100

OFFV\FV

OFFV\FV

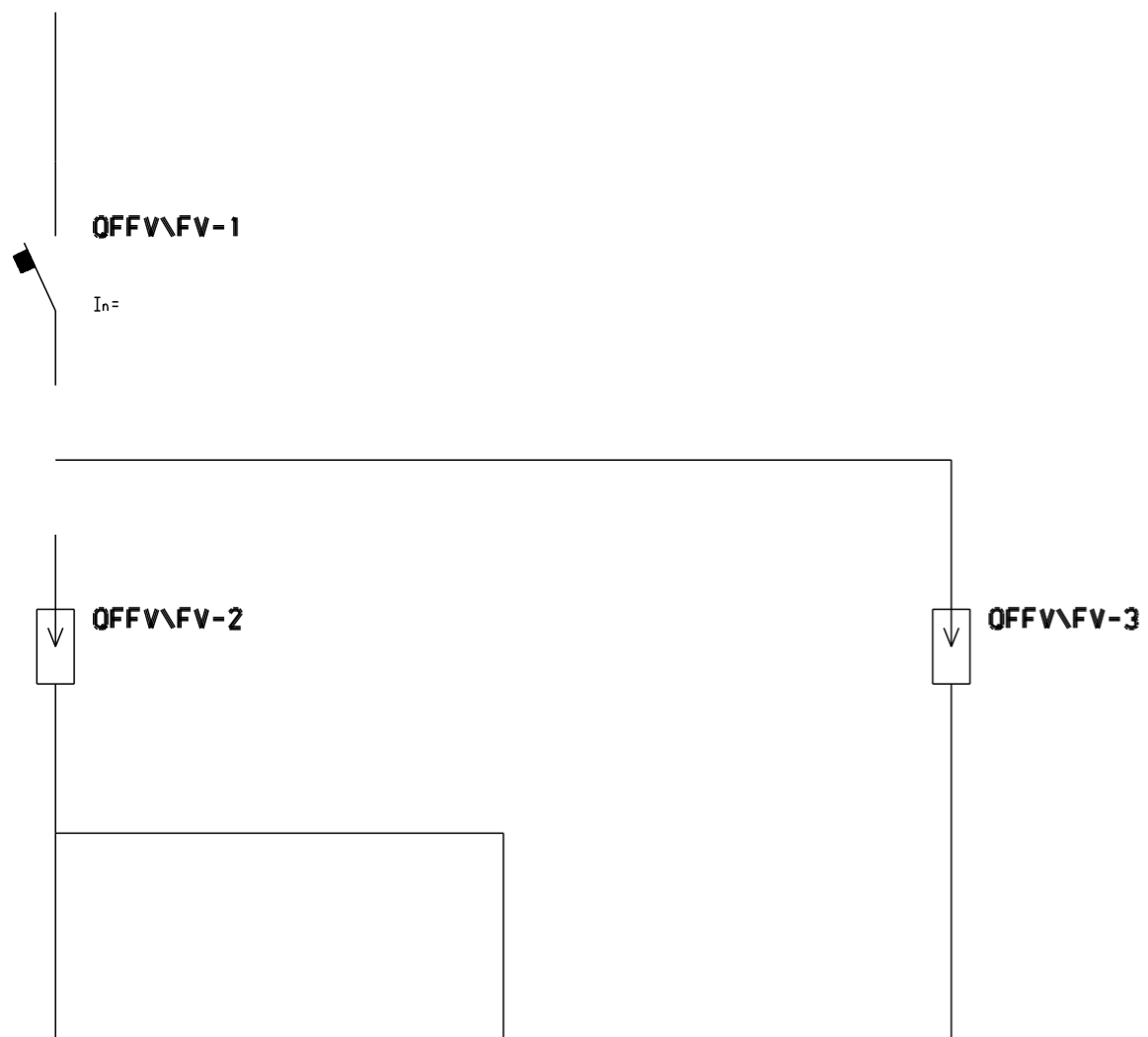

OFFV\FV - 3 MODULY

OFREG\KM

OFREG\KM

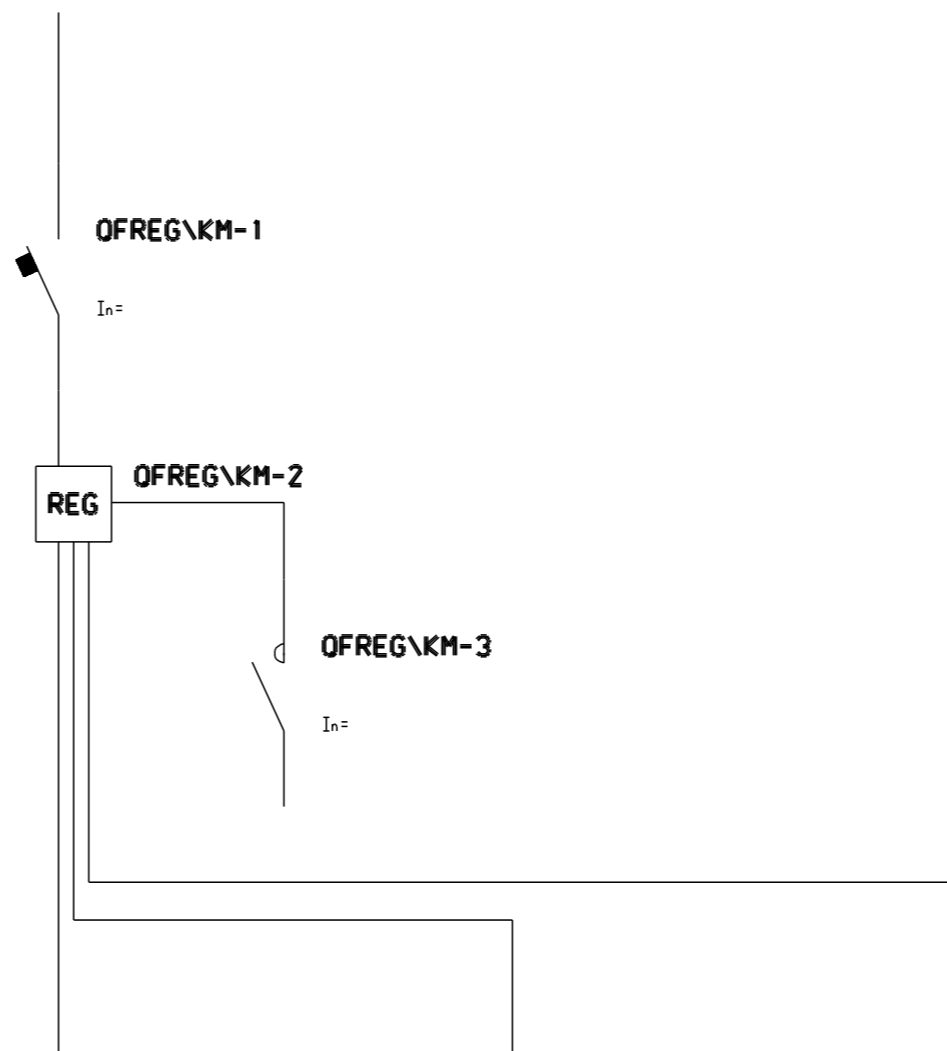

OFREG\KM - 3 MODULY

OFKAX

OFKAX

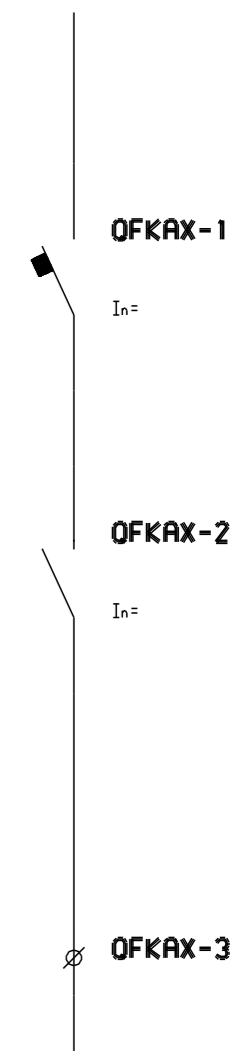

OF\T

OF\T

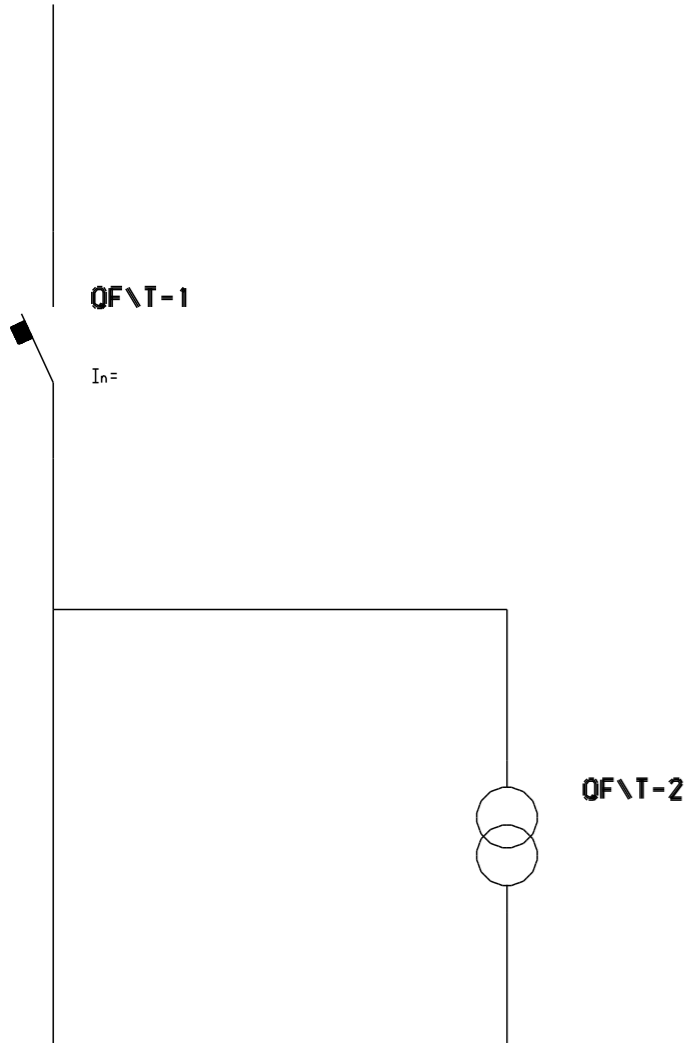

OF\T - 2 MODULY

OFKAOB2

OFKAOB2

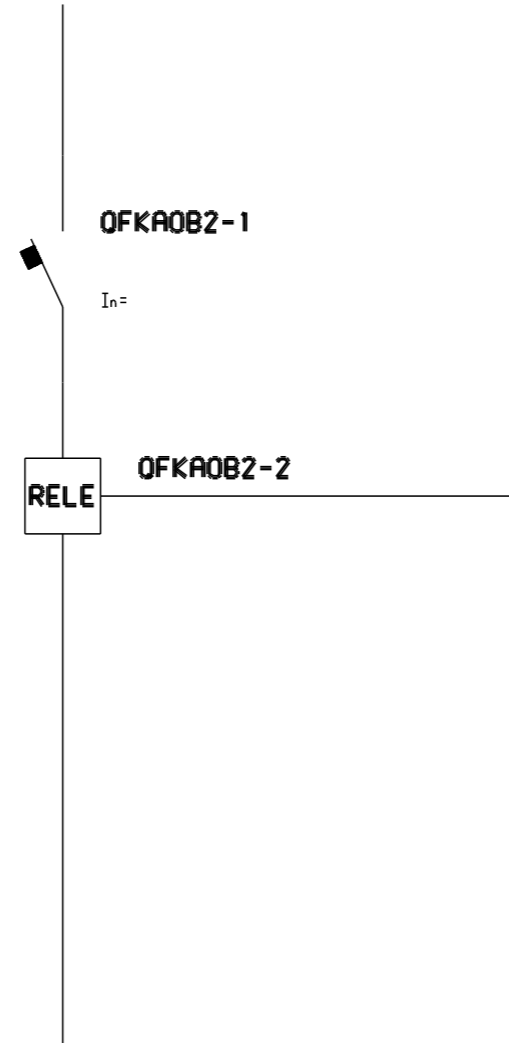

OFKAOB2 - 2 MODULY

<OF>OF_OSF

<OF>OF_OSF

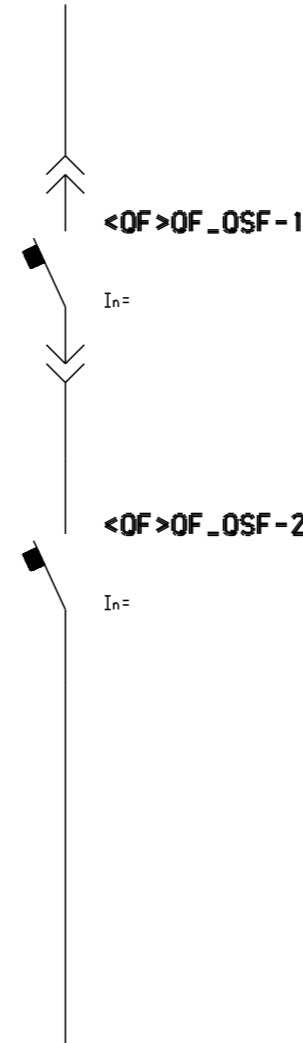

<OF>OF_OSF-3

In=

<OF><OF>_OSF\OSF

<OF><OF>_OSF\OSF

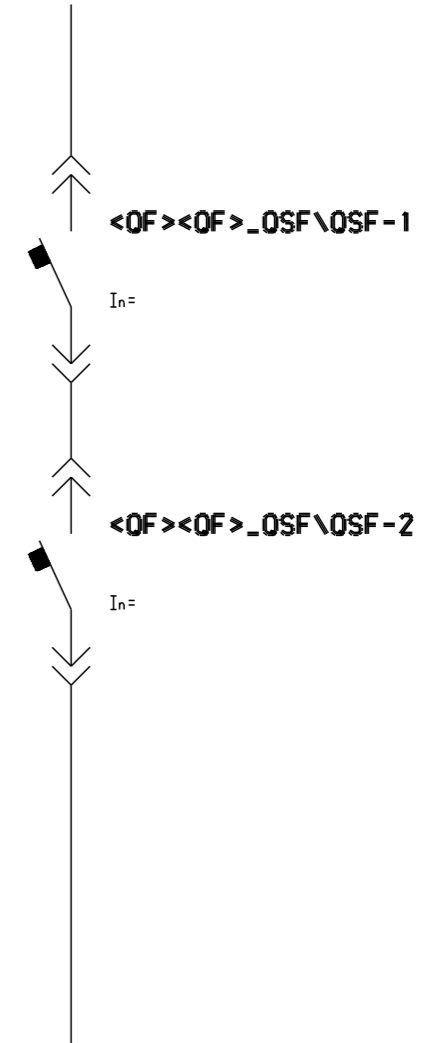

<OF><OF>_OSF\OSF - 2 MODULY

<OF><OF>_OSF\OSF-3

In=

<OF><OF>_OSF\OSF

In=

<OF>_OSF\OSF

<OF>_OSF\OSF

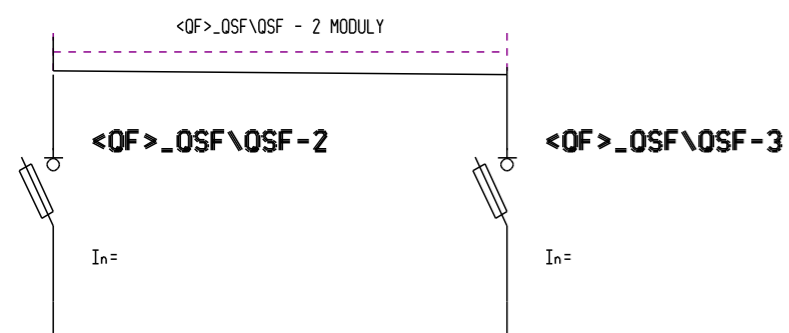
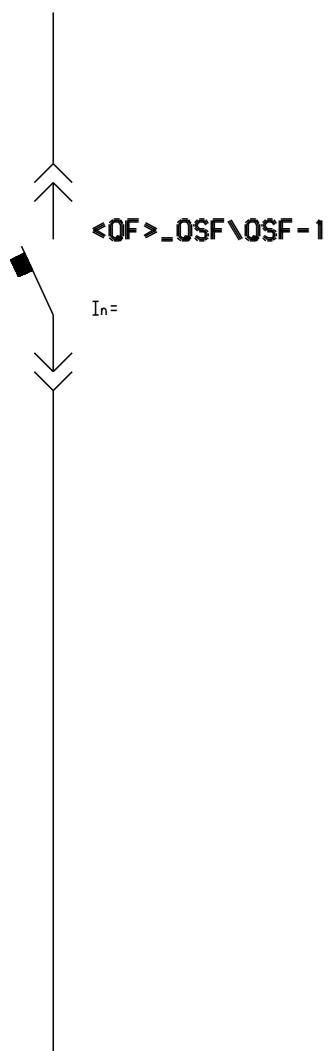

<OF>FA_OSF

<OF>FA_OSF

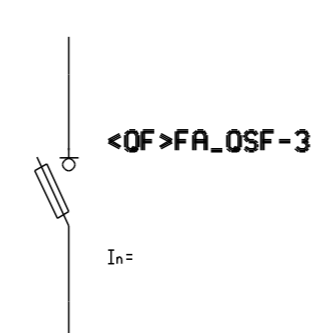
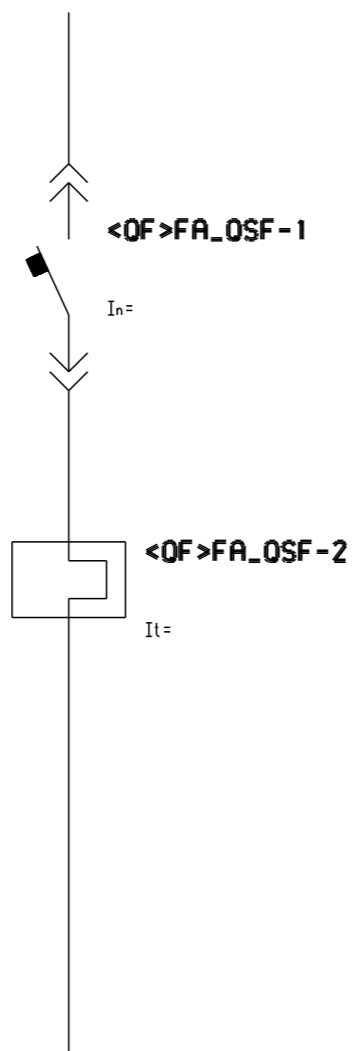

<OF><QM>

<OF><QM>

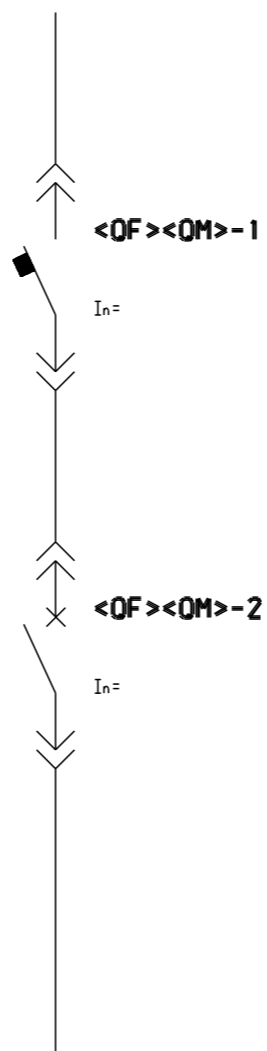

OFKM3FAX

OFKM3FAX

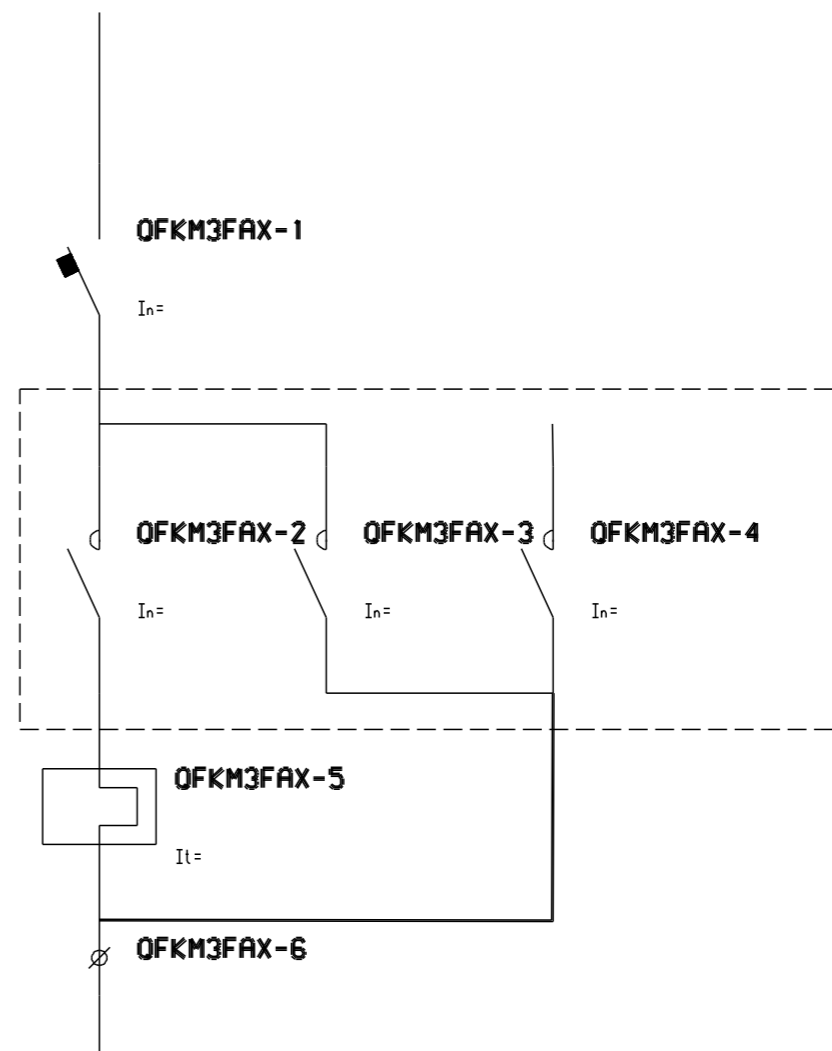

OFKM3FAX - 2 MODULY

<OF>_OF

<OF>_OF

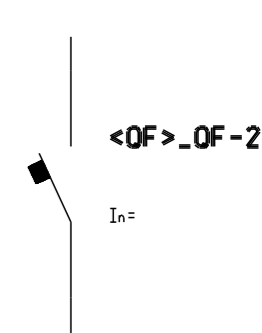
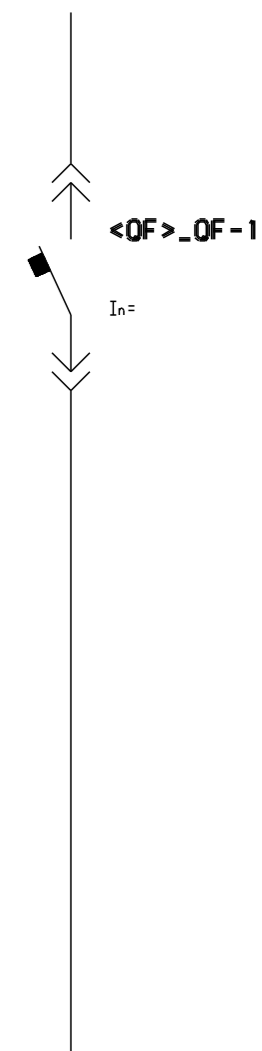

QFKMX\KM

QFKMOM

QFSV

QFTETO

QFX\KA

PROF\QF\QSFFV

QFKMX\KM

QFKMOM

QFSV

QFTETO

QFX\KA

PROF\QF\QSFFV

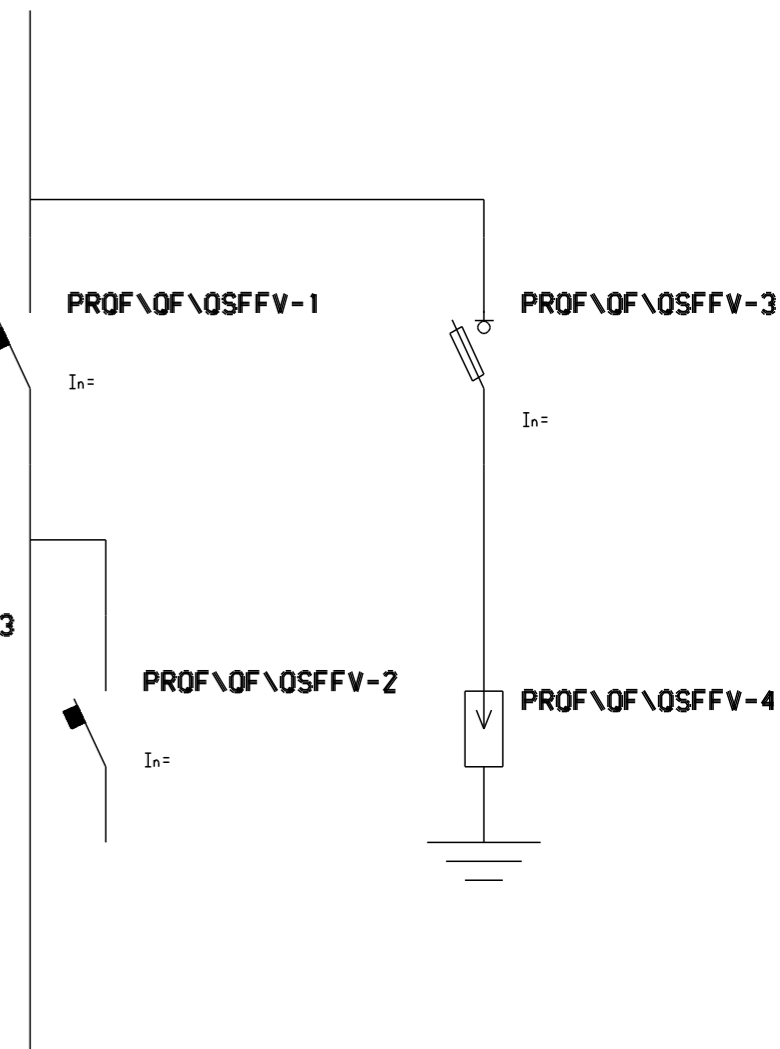
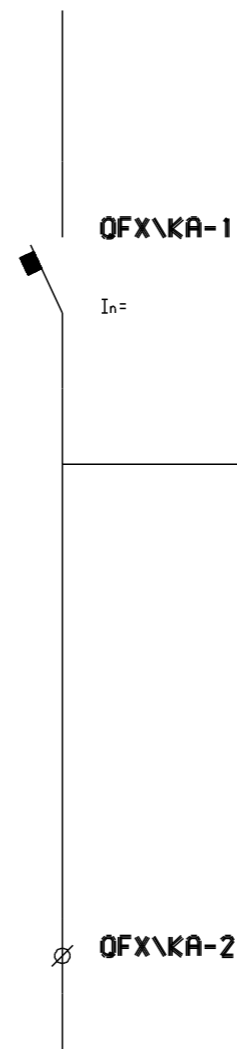
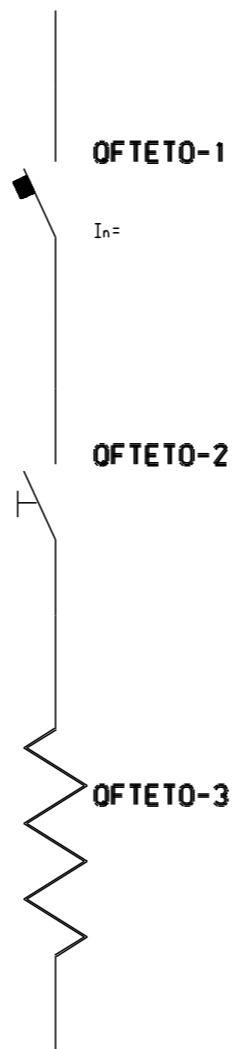
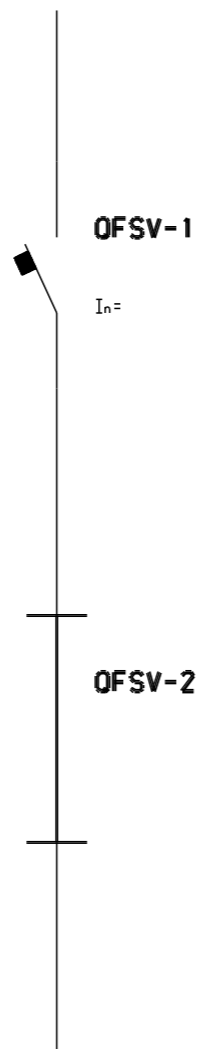
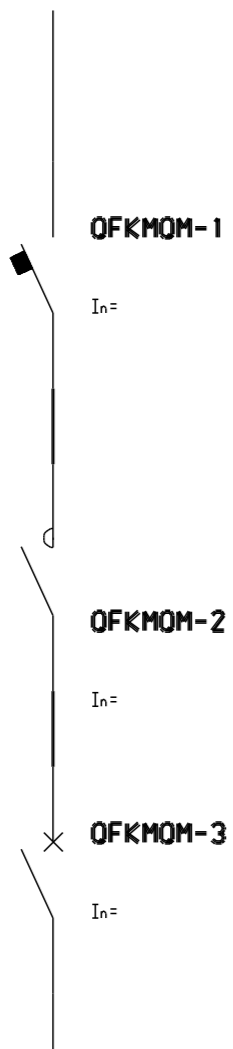
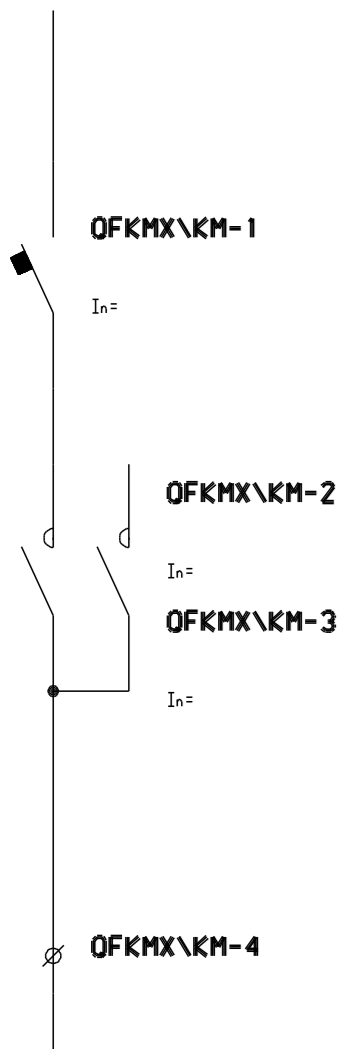

PROF\QF\QSFFV - 2 MODULY

OFFIOKMX\X

FIO

FIOX

OFFIOX

OFKM\KM

OFFIOKMX\X

FIO

FIOX

OFFIOX

OFKM\KM

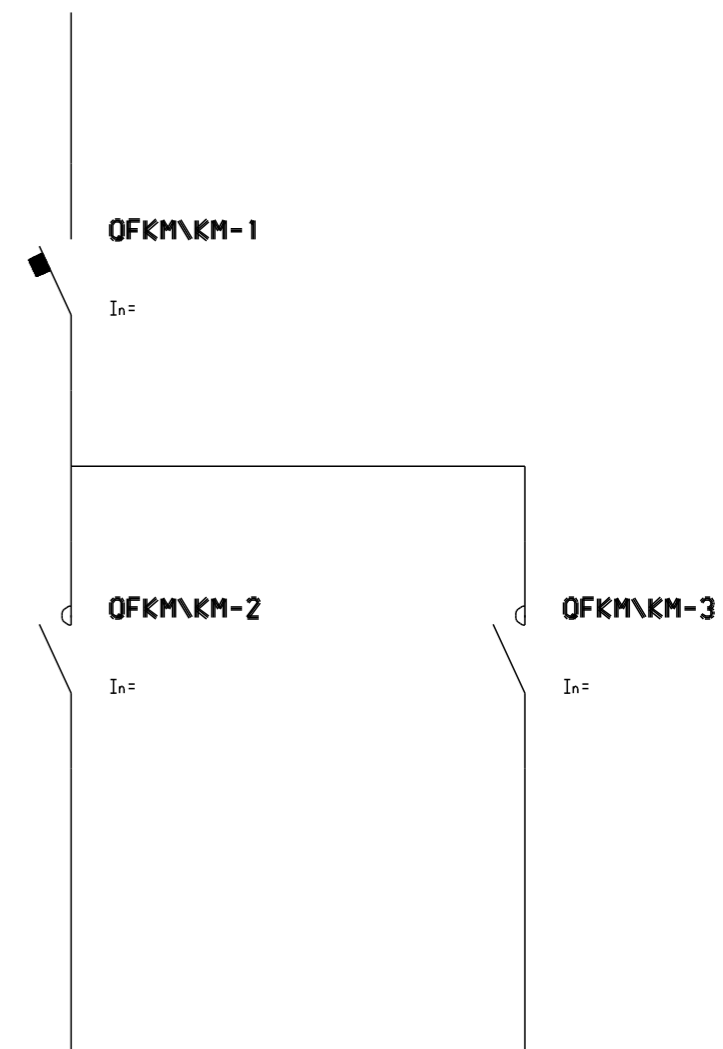
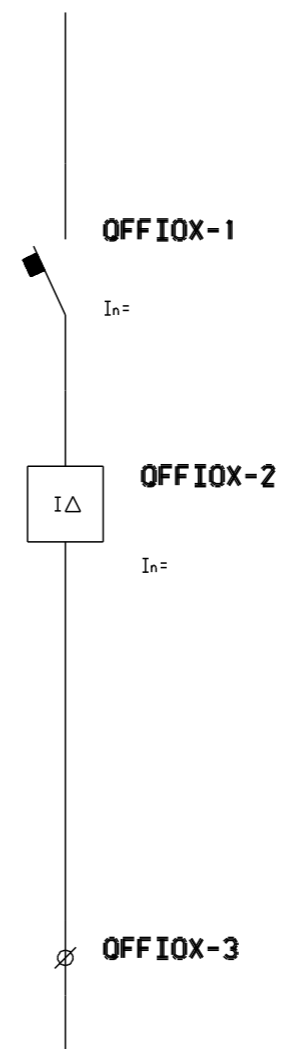
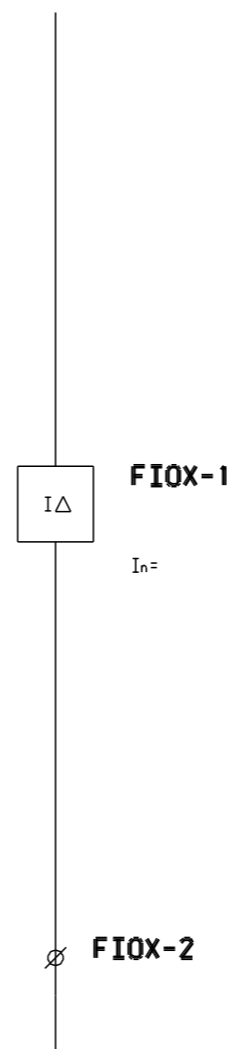
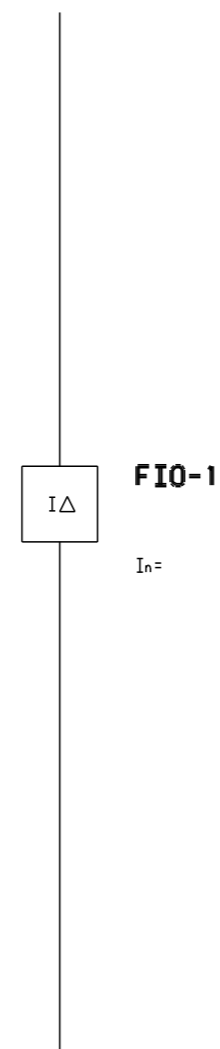
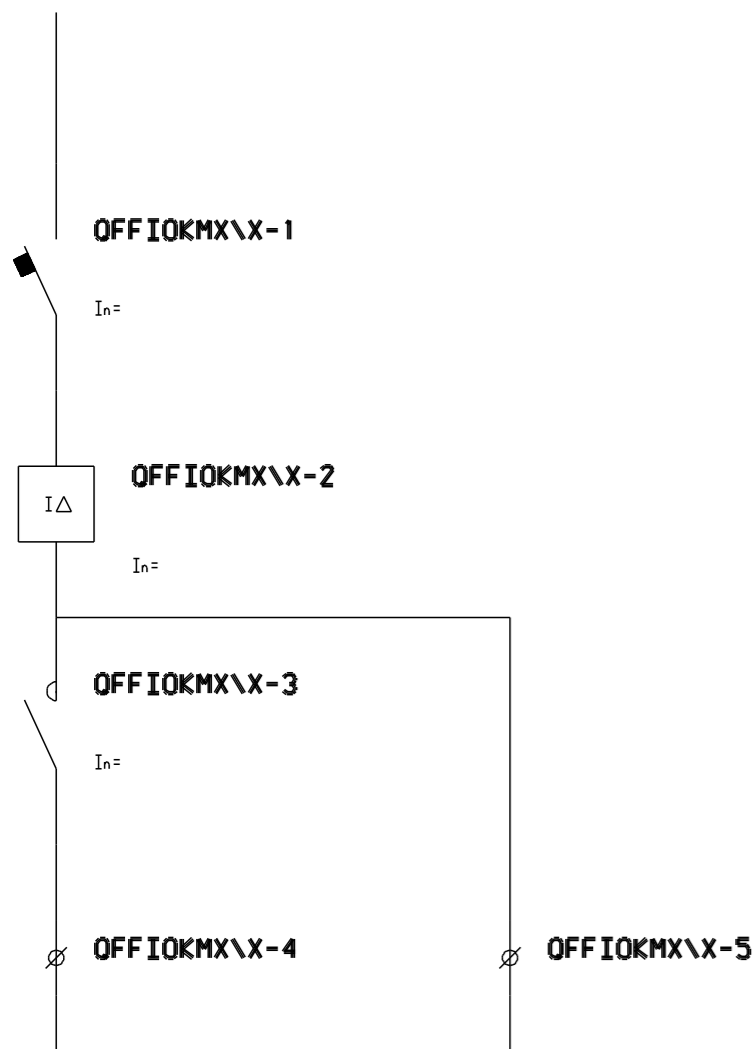

OFFIOKMX\X - 2 MODULY

OFKM\KM - 2 MODULY

OFSTM2

OFSTM2

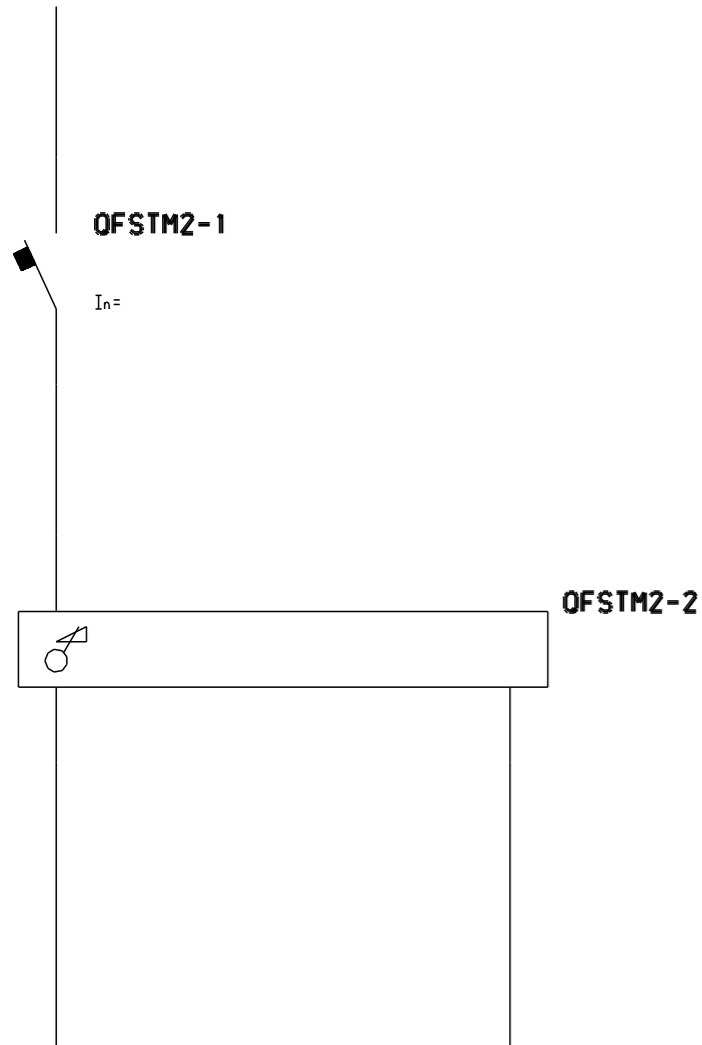

OFSTM2 - 2 MODULY

OFSTM4

OFSTM4

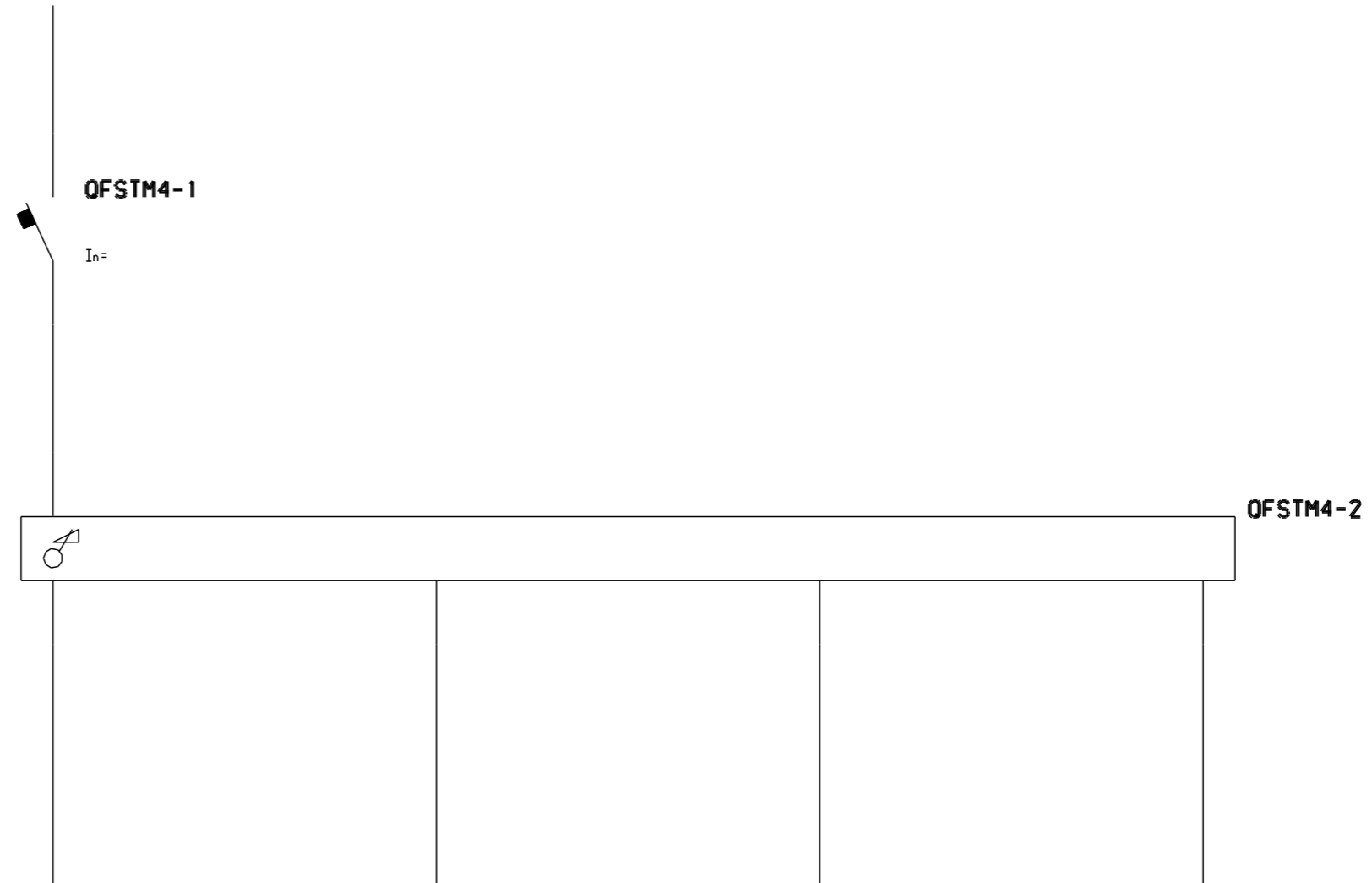

OFSTM4 - 4 MODULY

OFFA

OFFA

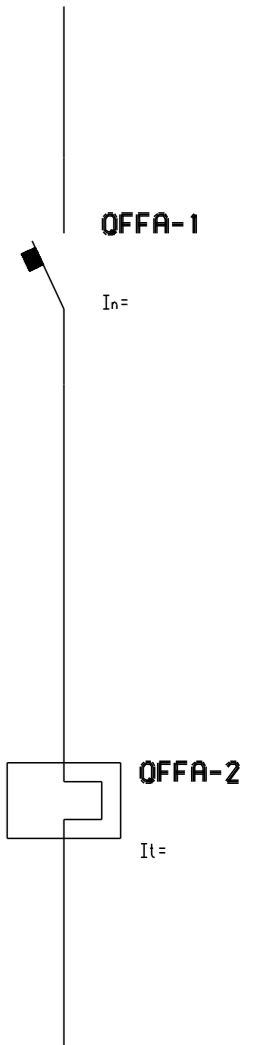

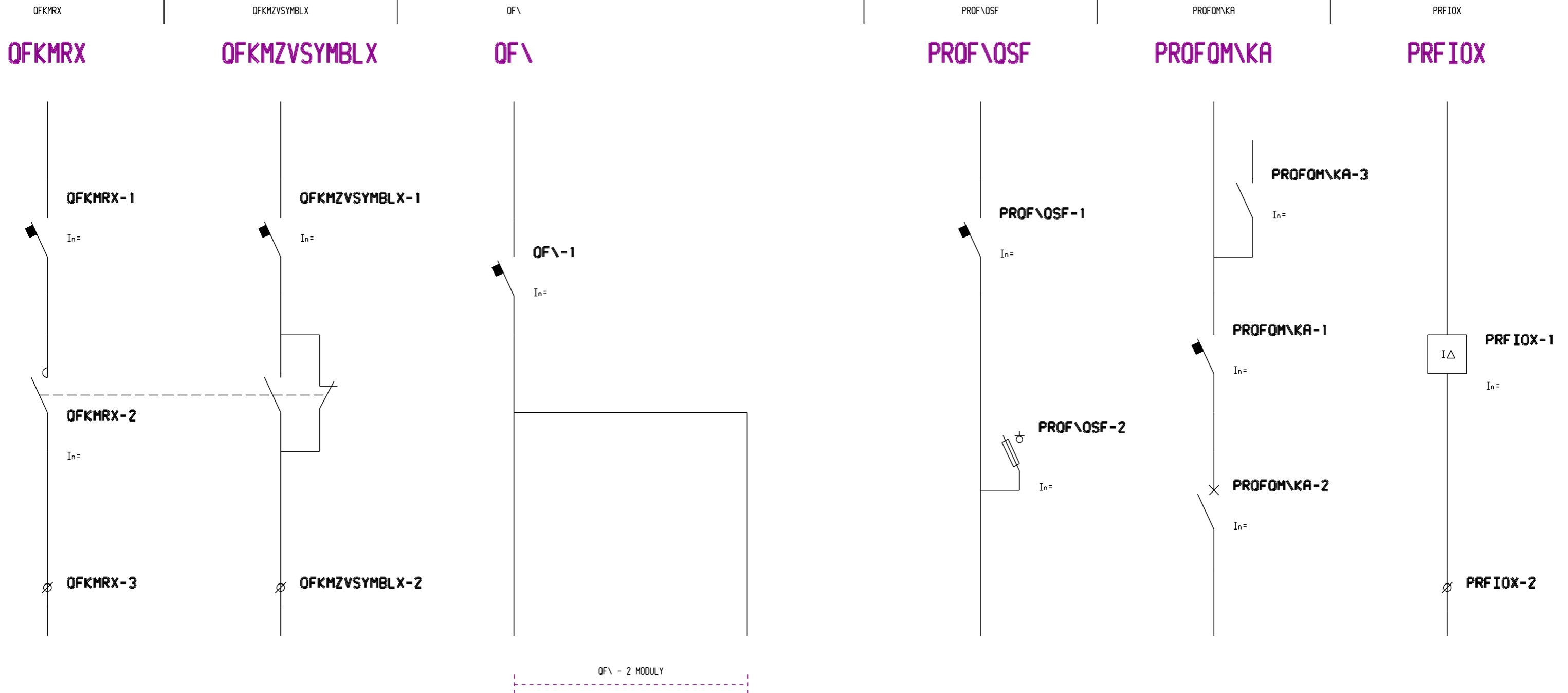

PR<OF>\QM

OF<OF>2F

OFKMFAX

PRTA2TA1OF

OFIOF\OF

PR<OF>\QM

OF<OF>2F

OFKMFAX

PRTA2TA1OF

OFIOF\OF

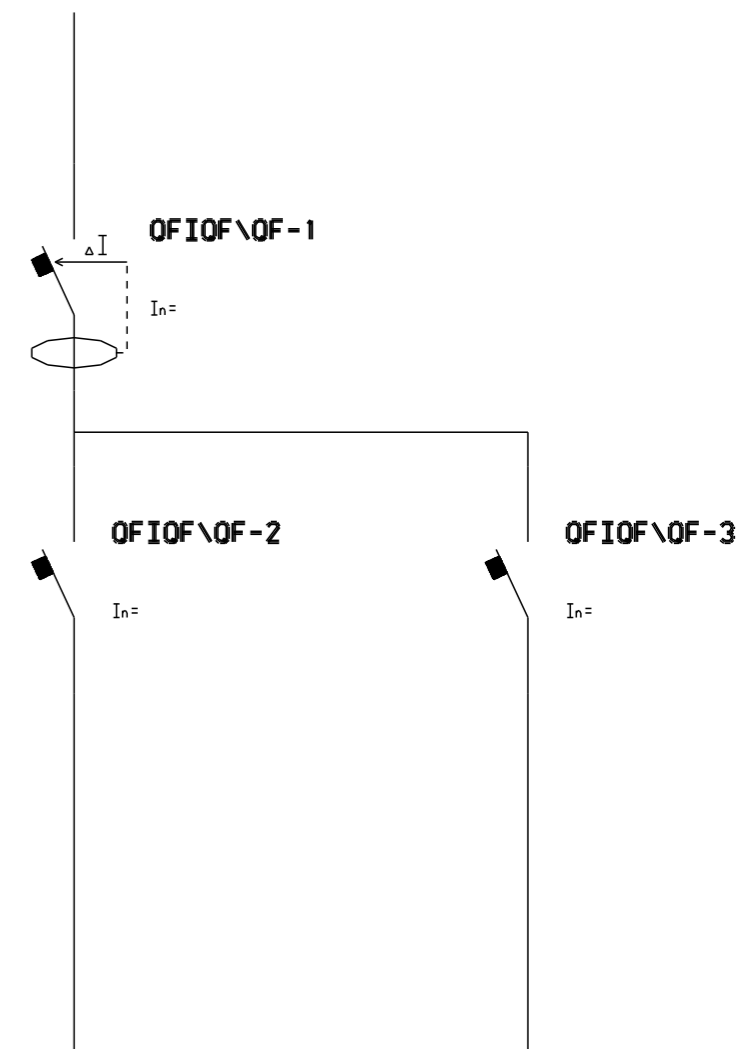
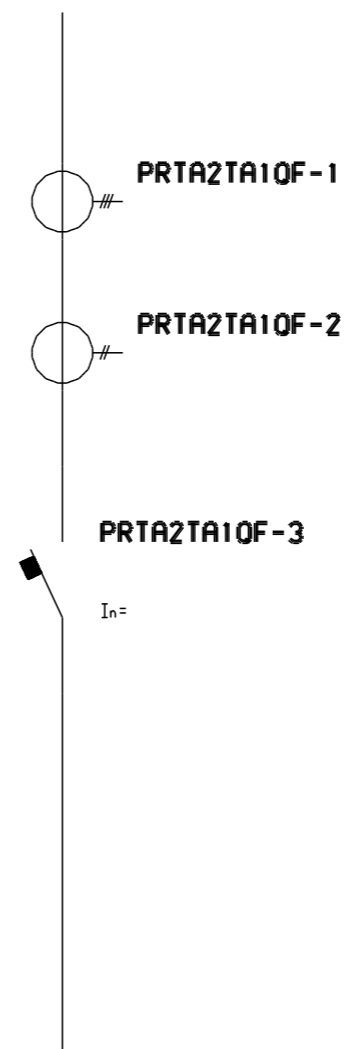
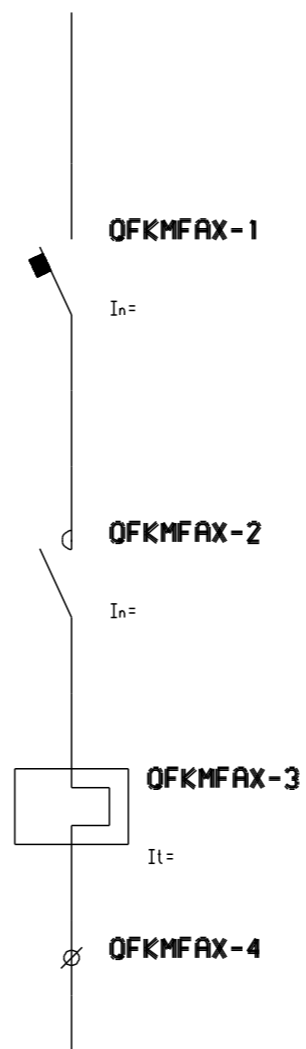
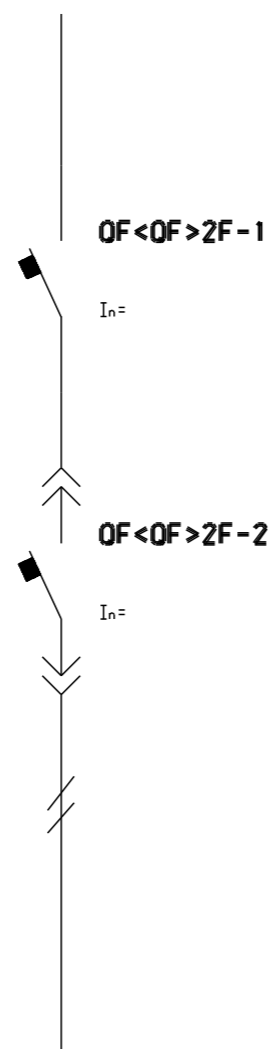
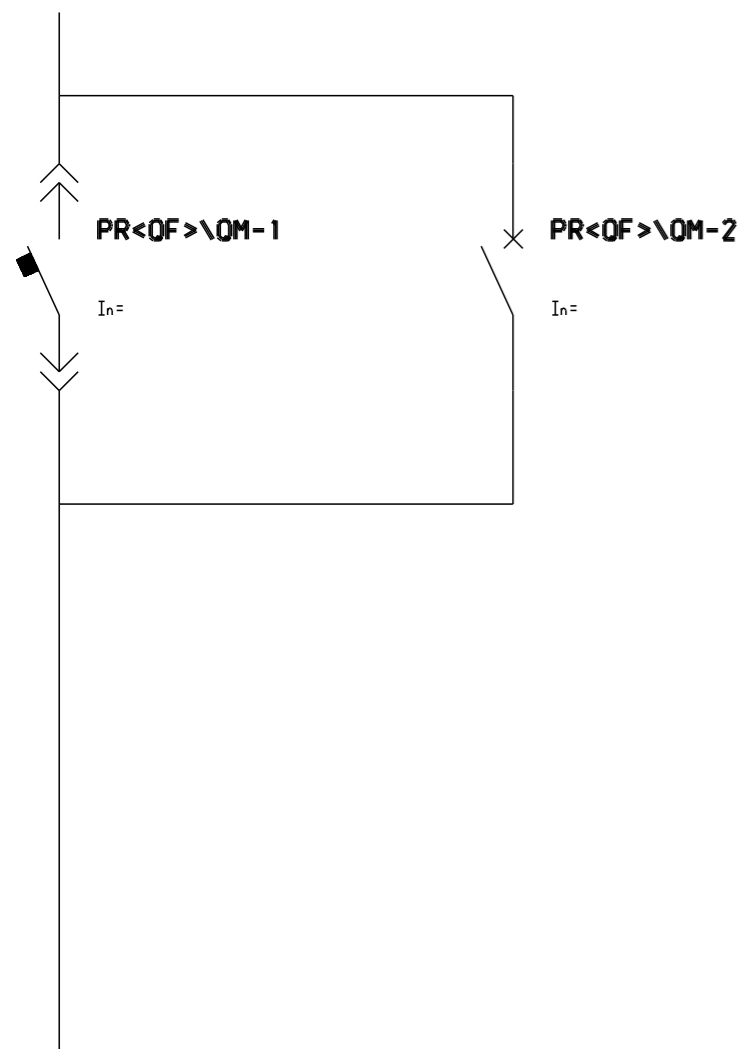

PR<OF>\QM - 2 MODULY

OFIOF\OF - 2 MODULY

OFKMFAX\X

PR<QF>TAX\QSFA

PR<QF>TAX\OSFB

PROFD2X

QFD2X

PR<QF>X\QF

OFKMFAX\X

PR<QF>TAX\QSFA

PR<QF>TAX\OSFB

PROFD2X

QFD2X

PR<QF>X\QF

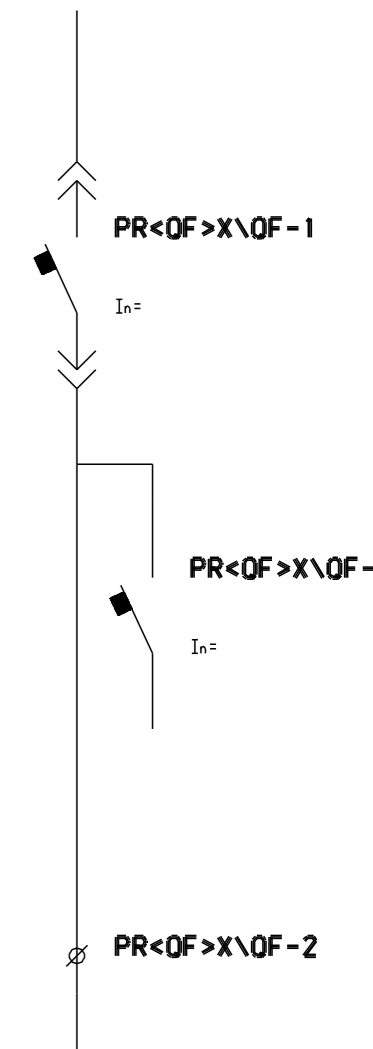
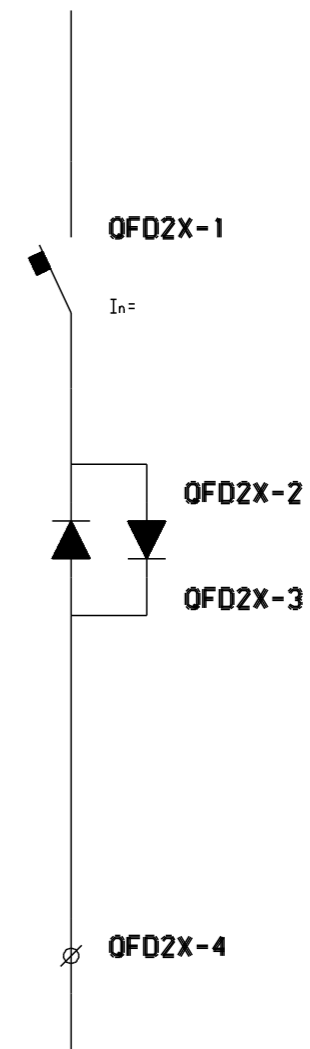
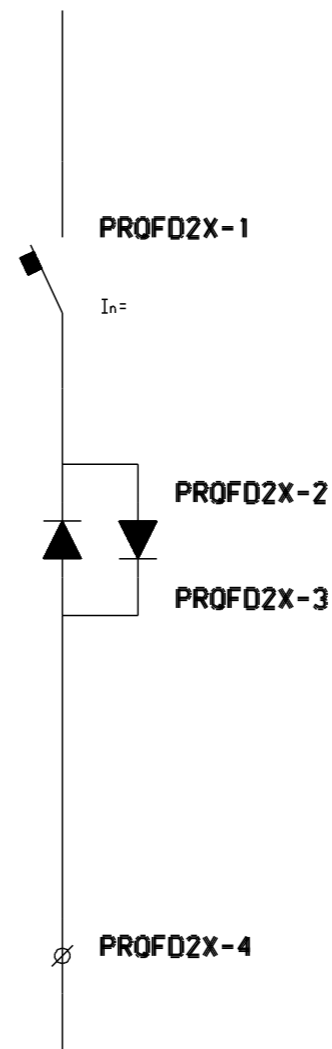
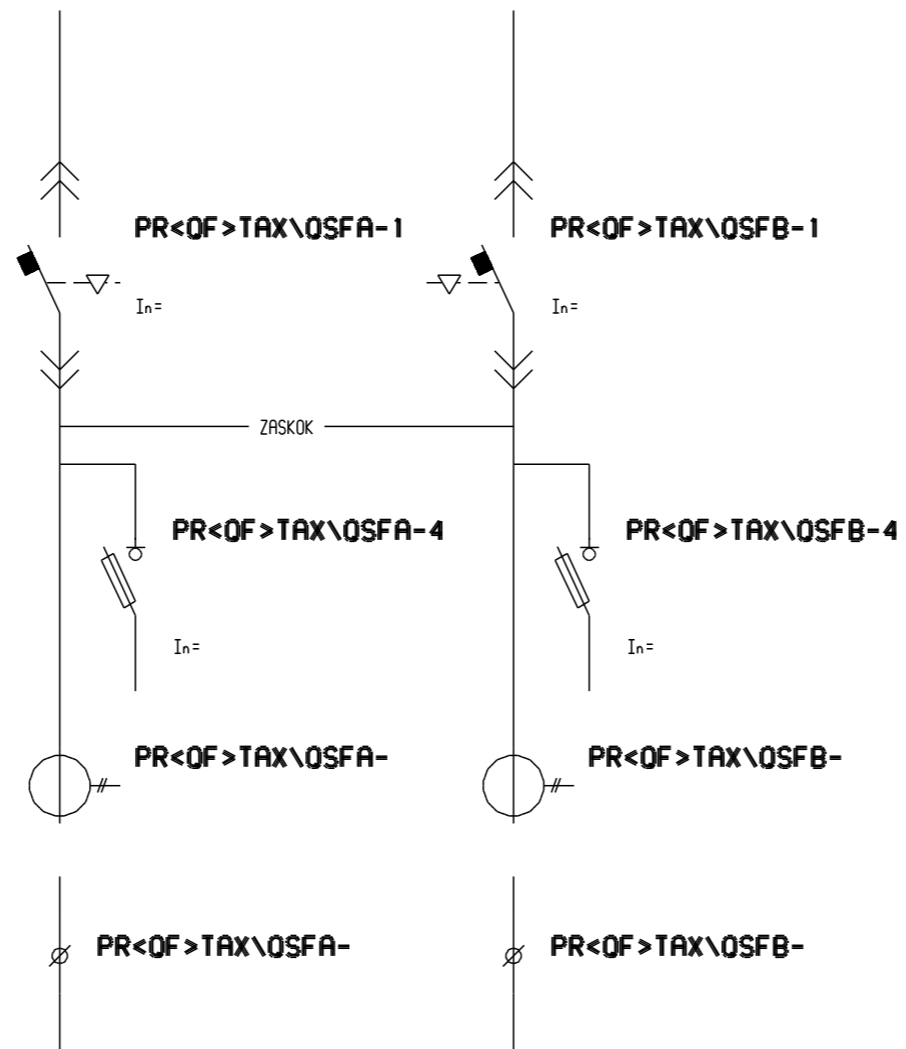
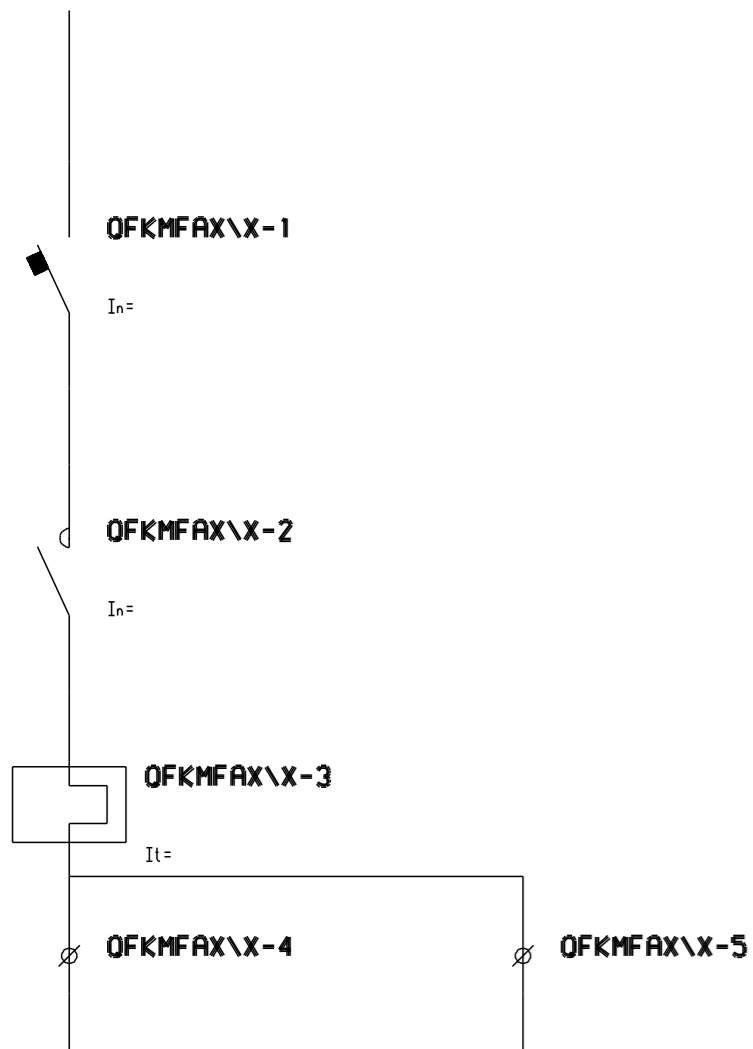

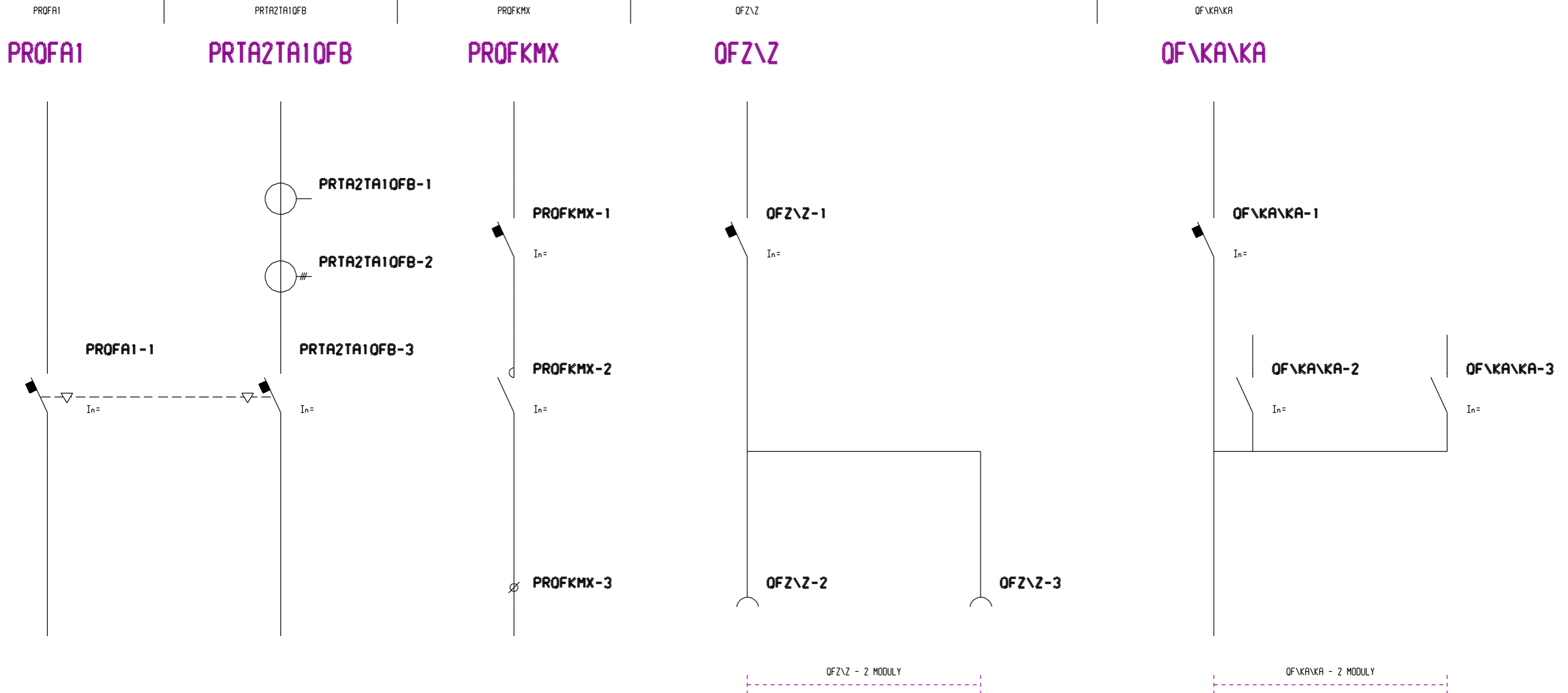

PRTA1<QF>TA2

<QF><QF>A

<QF><QF>B

QFKMX\X

QFX\X

PRTA1<QF>TA2

<QF><QF>A

<QF><QF>B

QFKMX\X

QFX\X

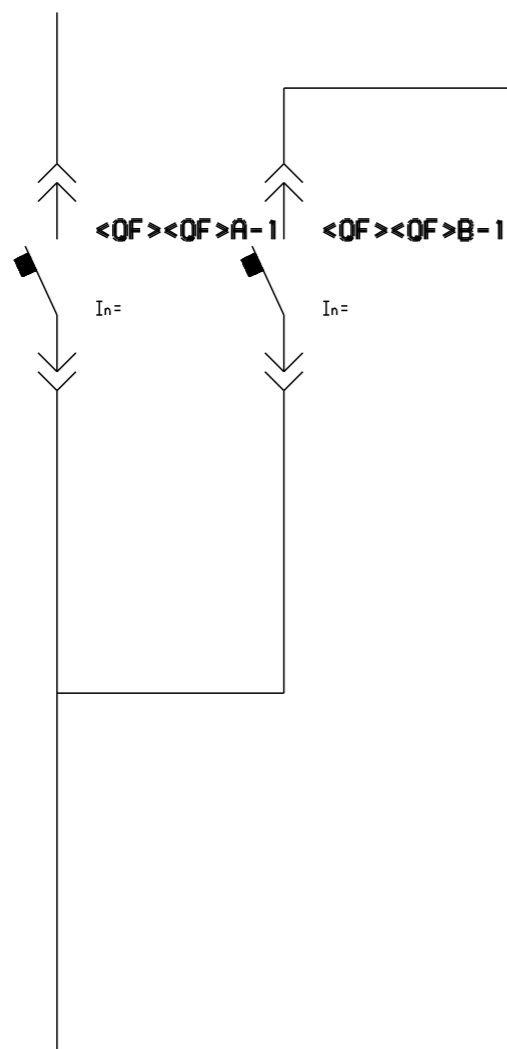
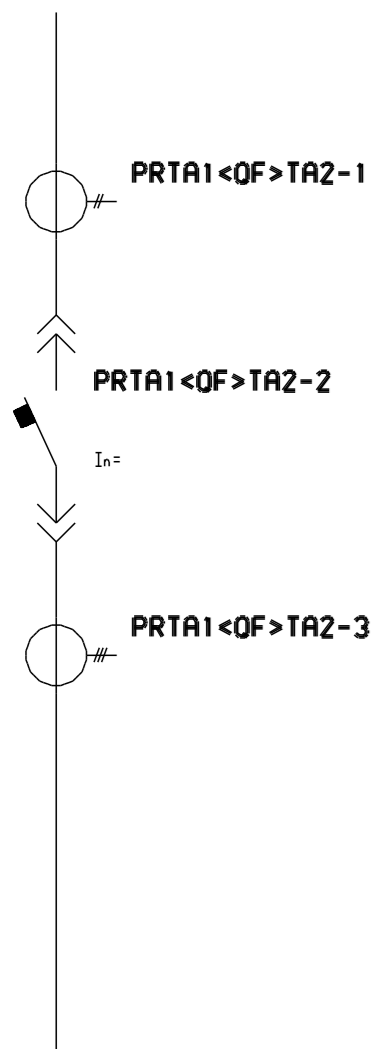

2 SAMOSTATNE MODULY POUZITELNE POUZE SPOLECNE

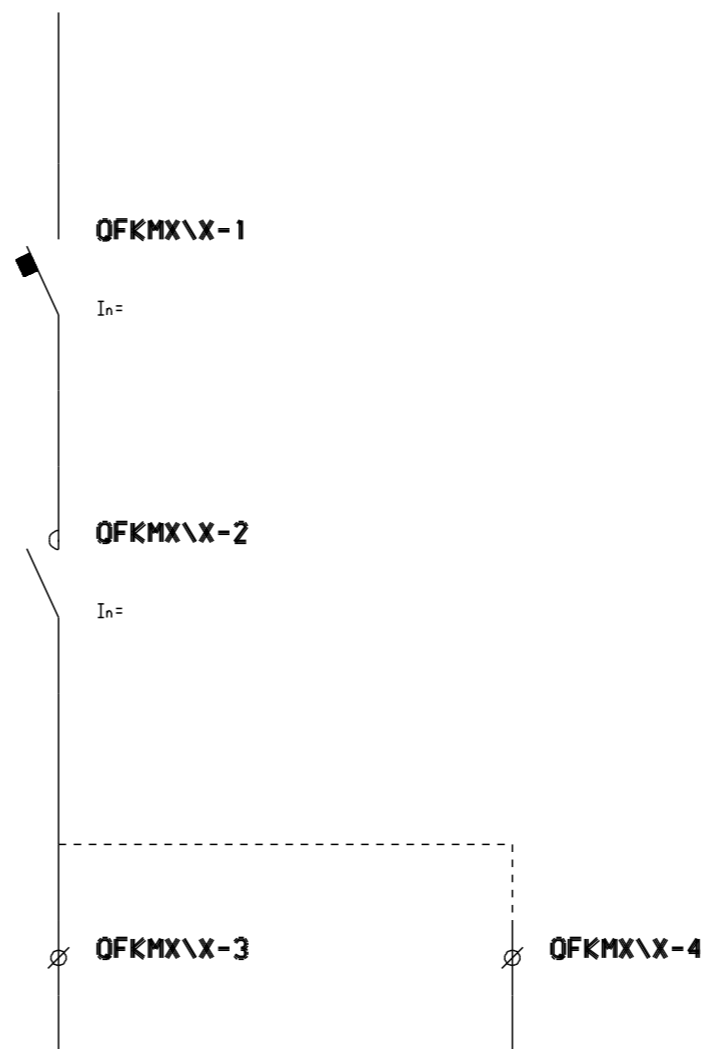

QFKMX\X - 2 MODULY

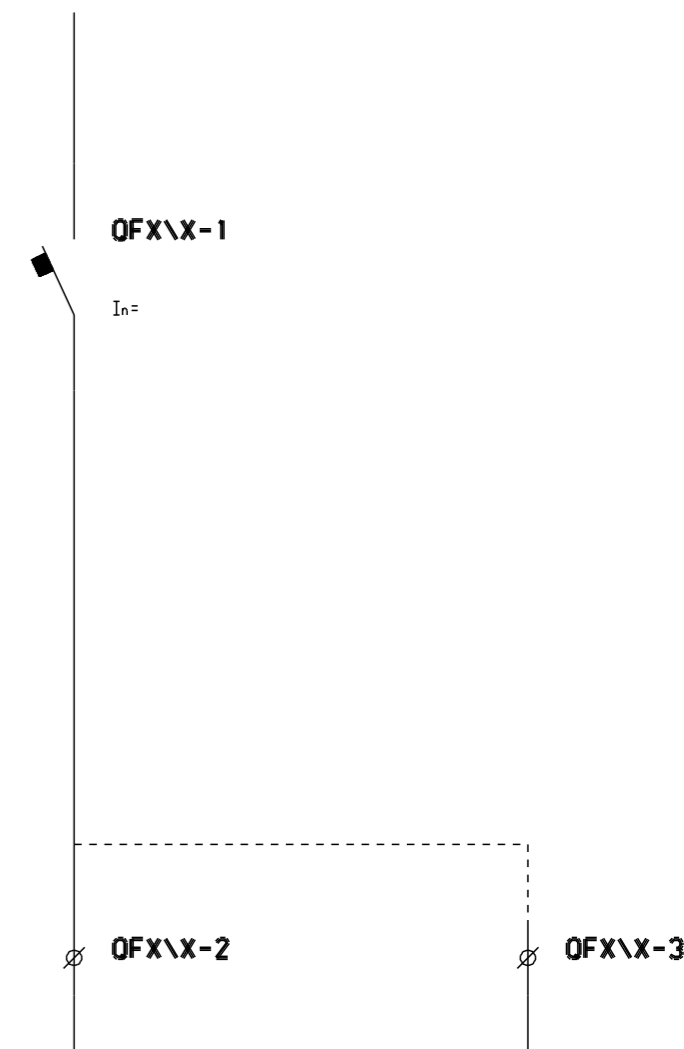

QFX\X - 2 MODULY

OFFIZ

OFFIZ

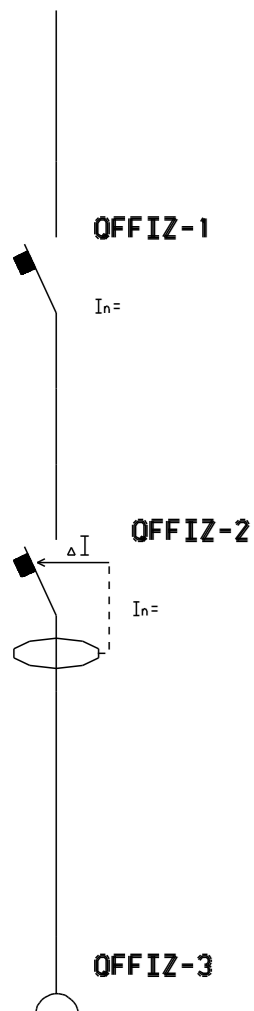

OFFIOZ

OFFIOZ

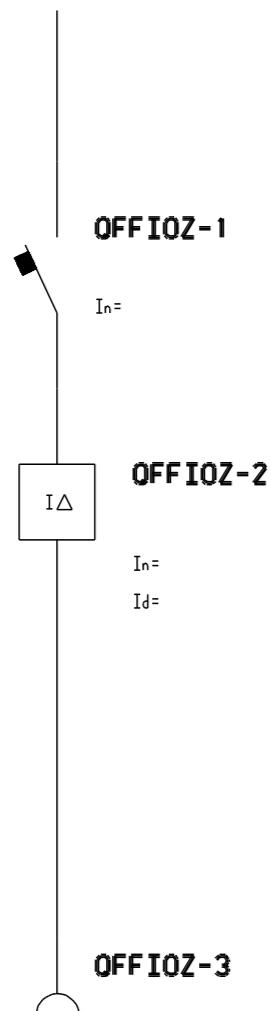

<OF>RA\OSFZ

<OF>RA\OSFZ

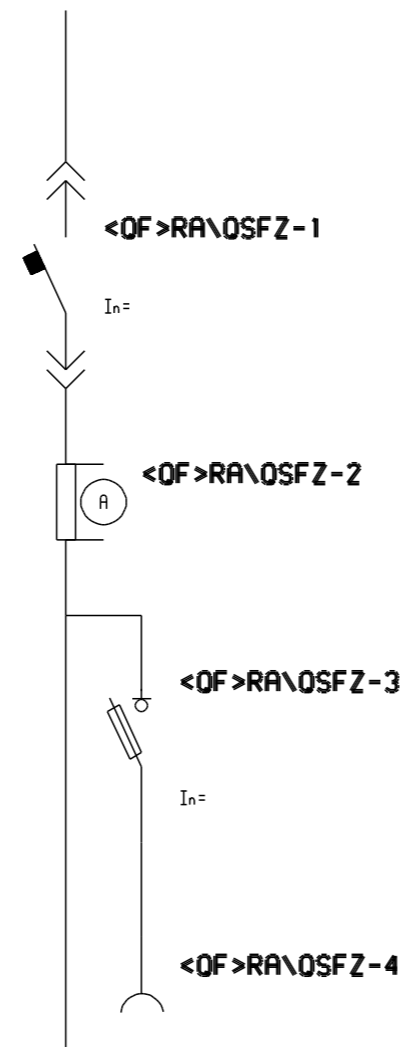

PR<OF>RA

PR<OF>RA

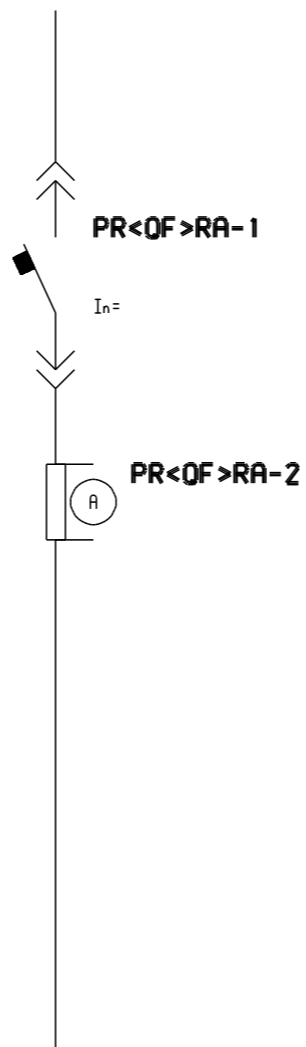

<OF>KMFATA1X

<OF>KMFATA1X

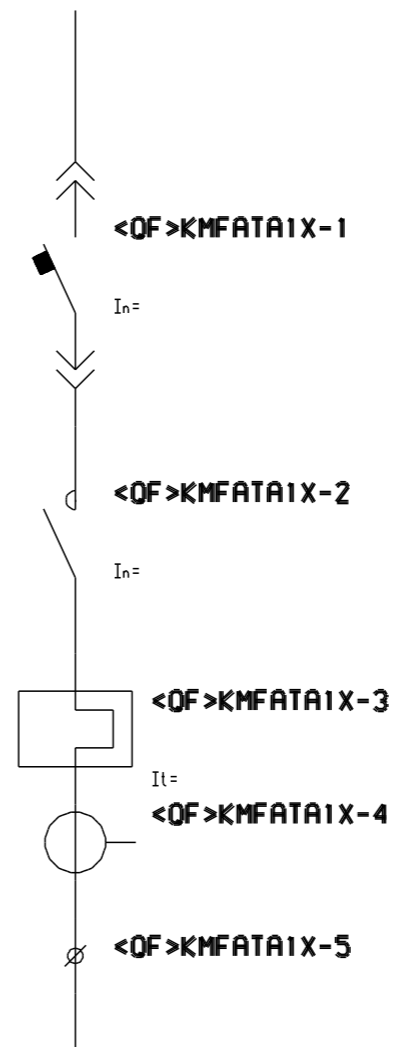

<OF>KMFAX

<OF>KMFAX

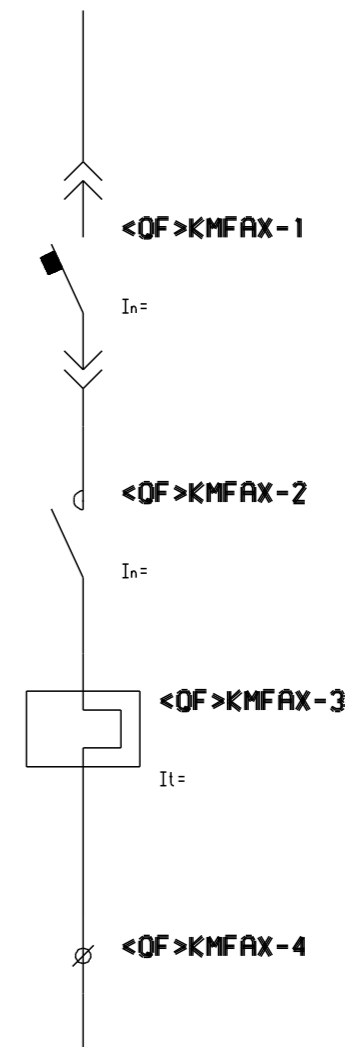

PR<OF>X\OSF

PR<OF>X\OSF

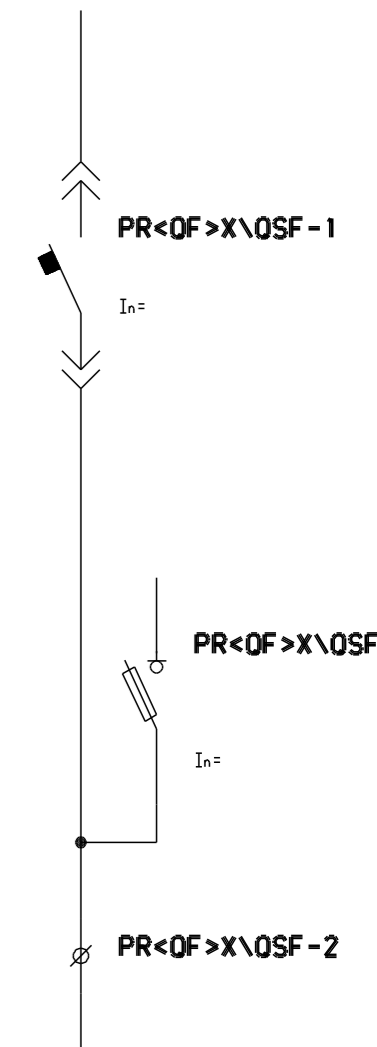

OF3KMX3

OF3KMX3

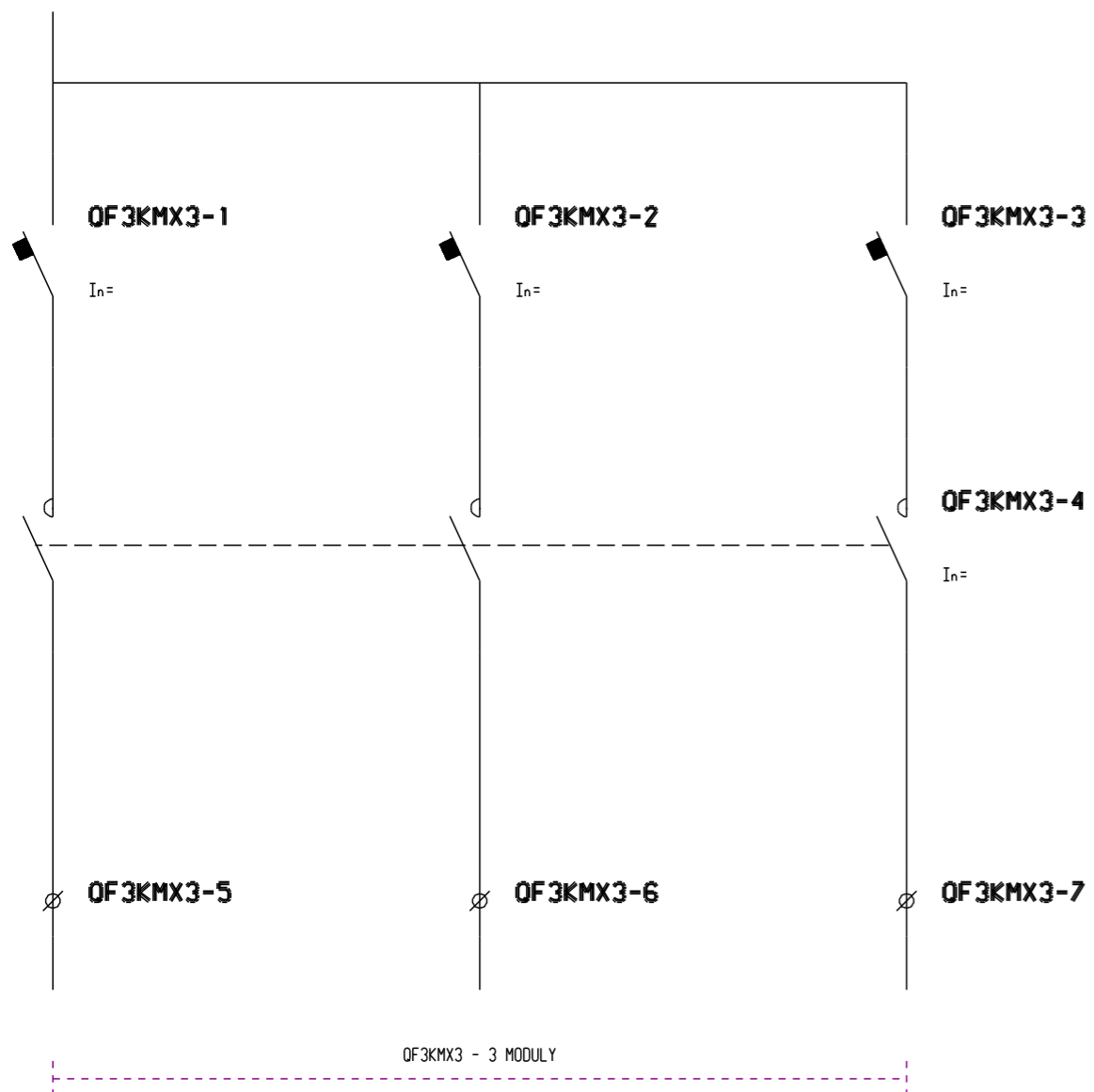

PR<OF>\FU\OF

PR<OF>\FU\OF

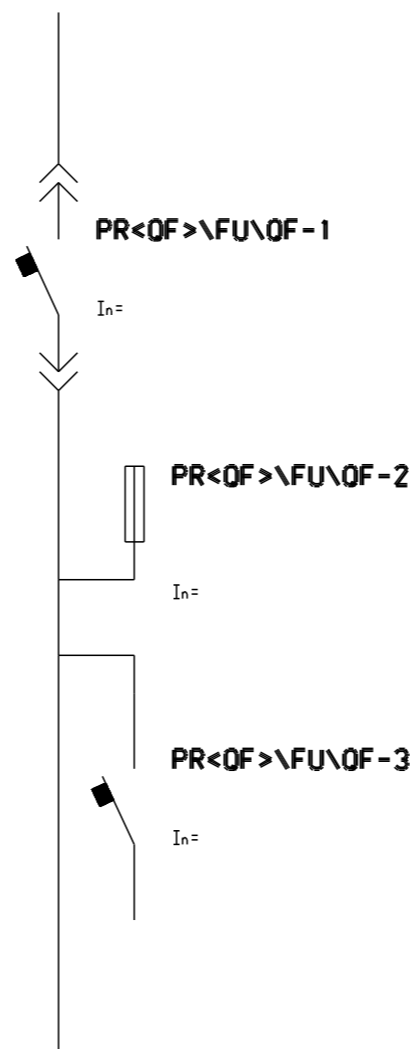

OFKM\KMX2

OFKM\KMX2

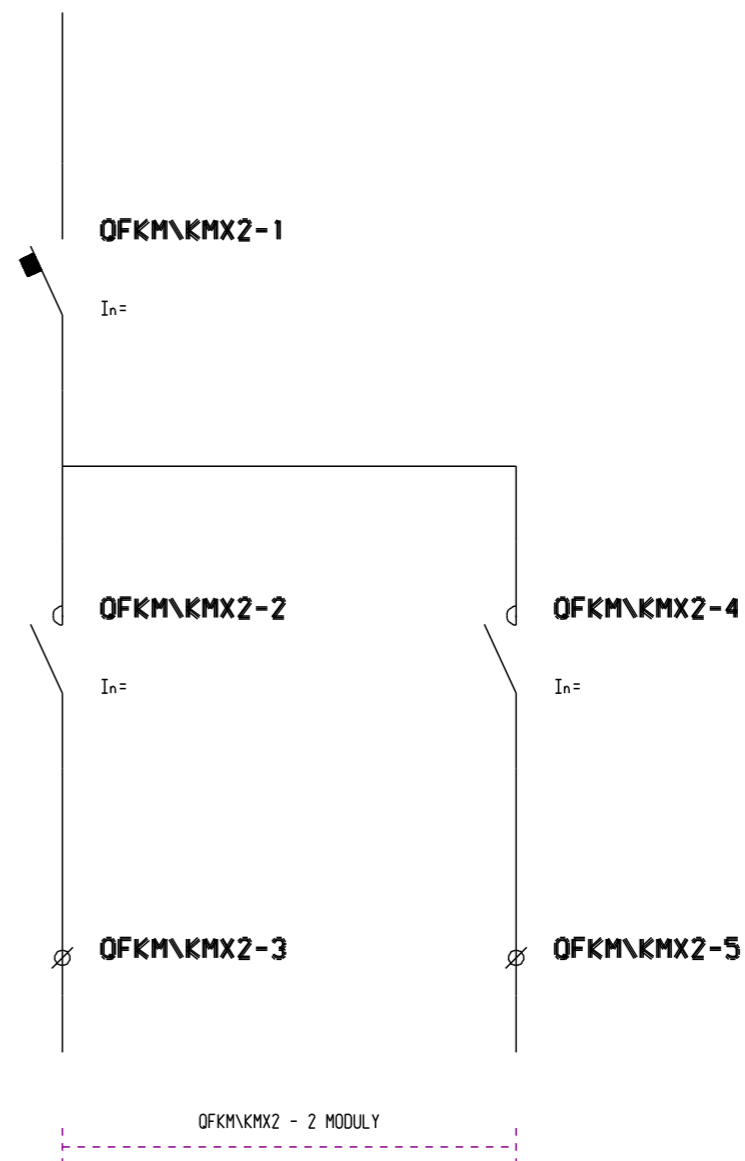

OF3KMX3_1

OFXT

OFOVLEDU

PROFW2

OFFAX

OF3KMX3_1

OFXT

OFOVLEDU

PROFW2

OFFAX

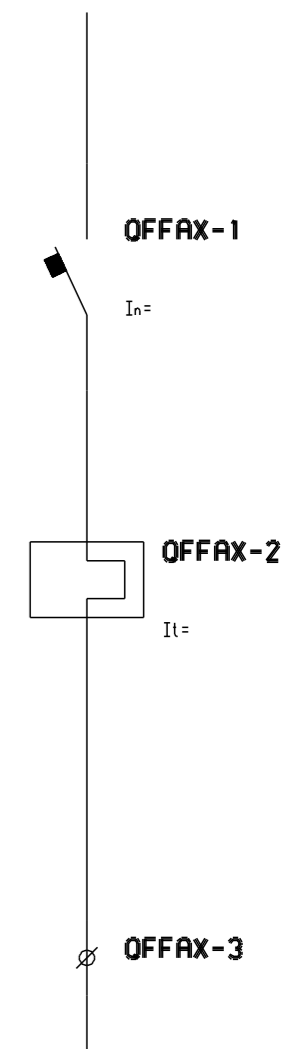
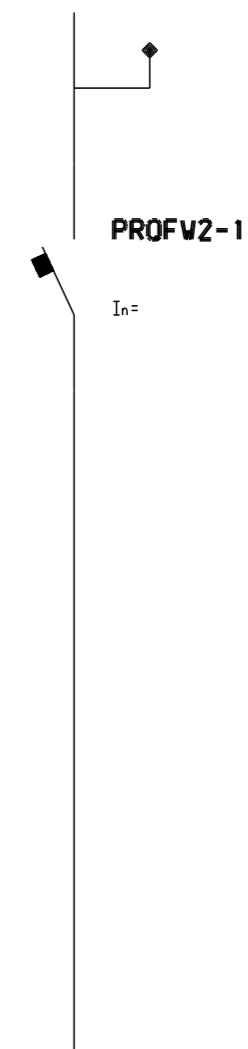
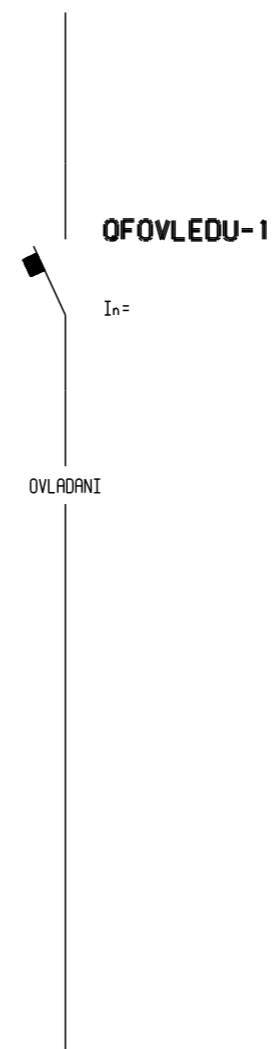
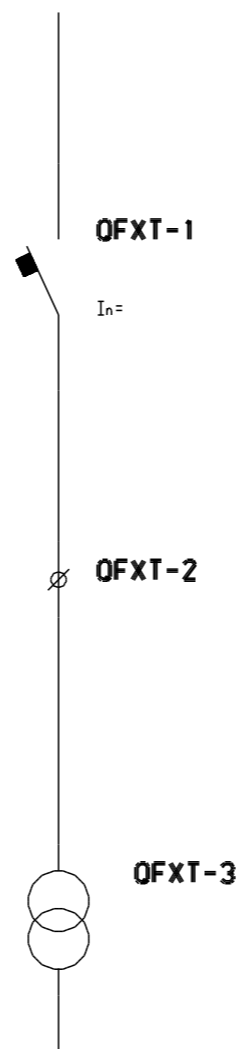
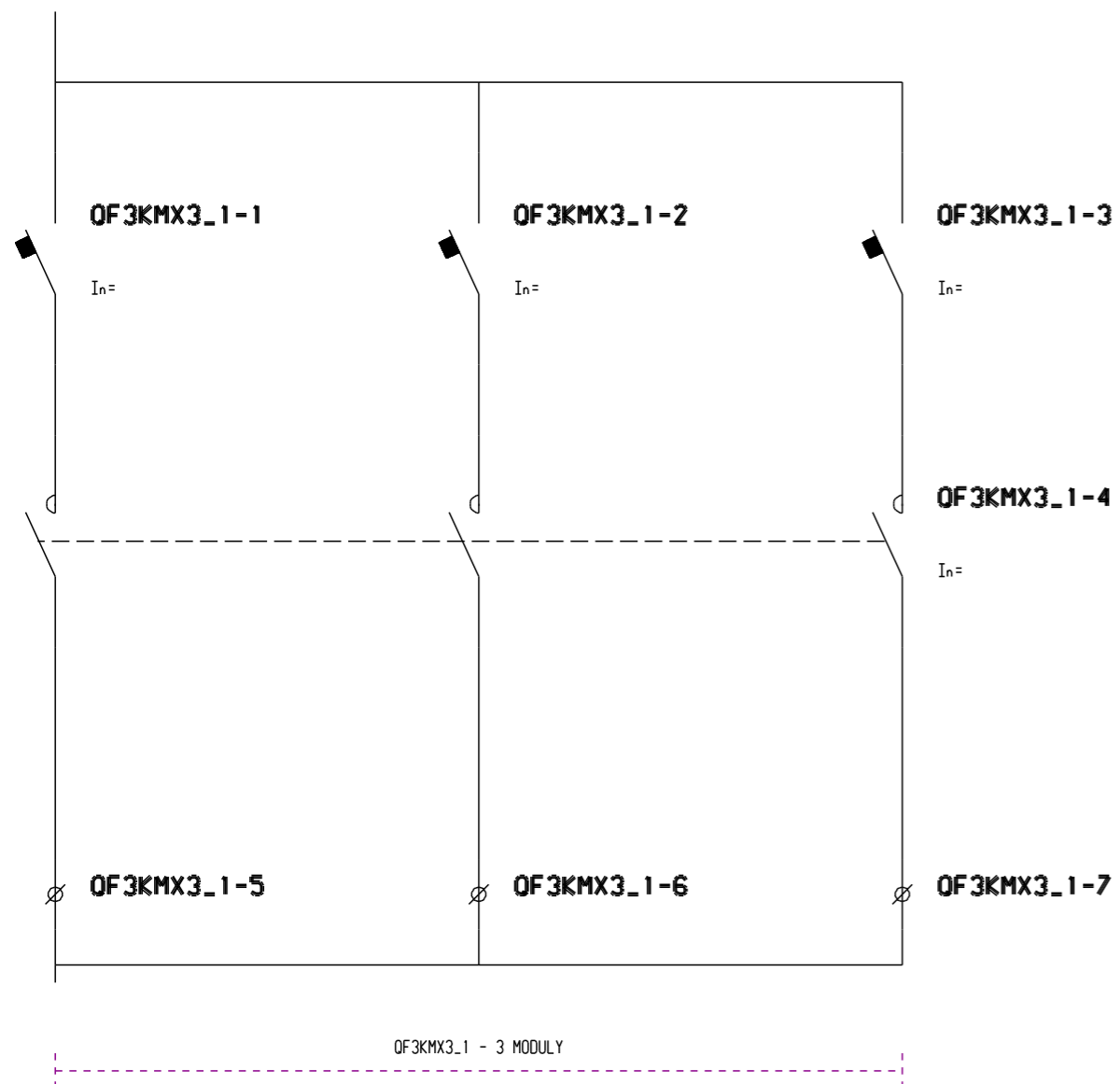

<OF>KMTA

PR<OF>RA\FUS\FU

PRTA1<OF>\FUS\FUS

PRTA1<OF>\FUSX

<OF>KMTAX

<OF>KMX

PRTA1<OF>\FUS\F

<OF>KMTA

PR<OF>RA\FUS\FUS

PRTA1<OF>\FUS\FUS

PRTA1<OF>\FUSX

<OF>KMTAX

<OF>KMX

PRTA1<OF>\FUS\FUSX

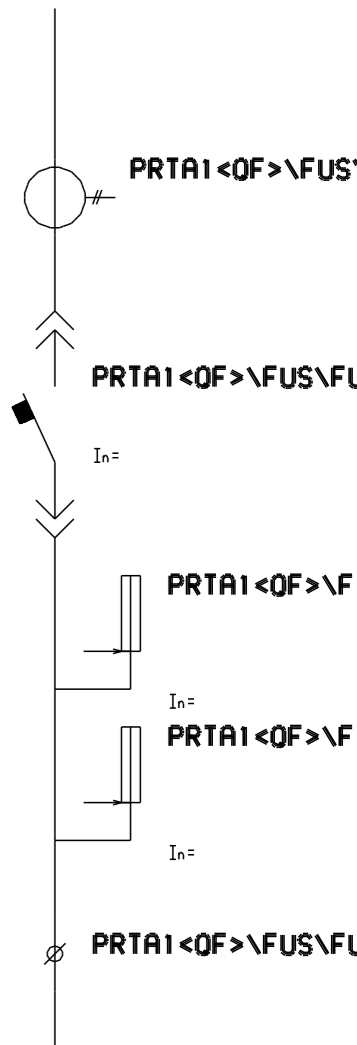
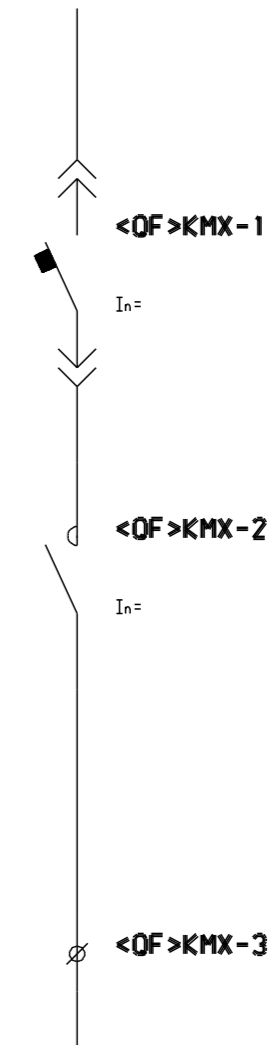
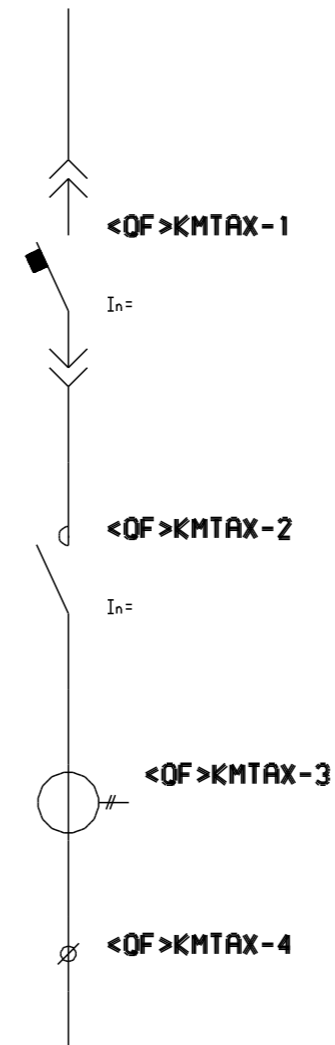
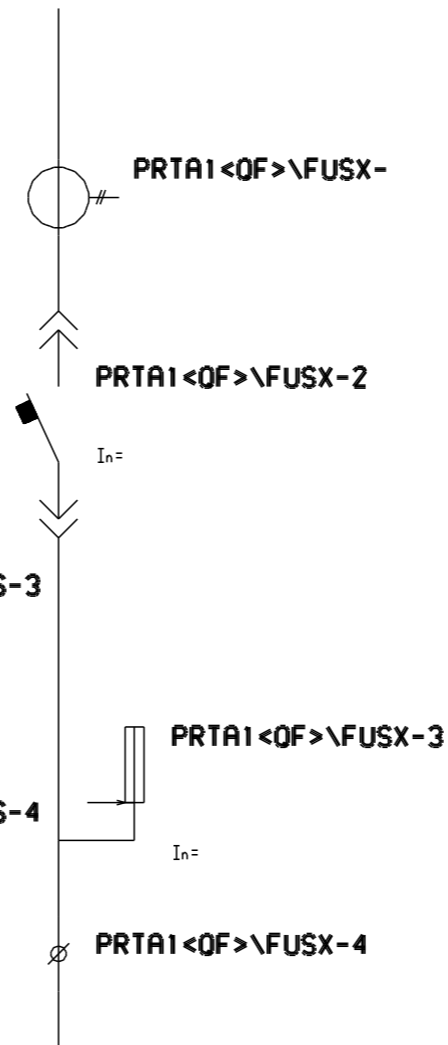
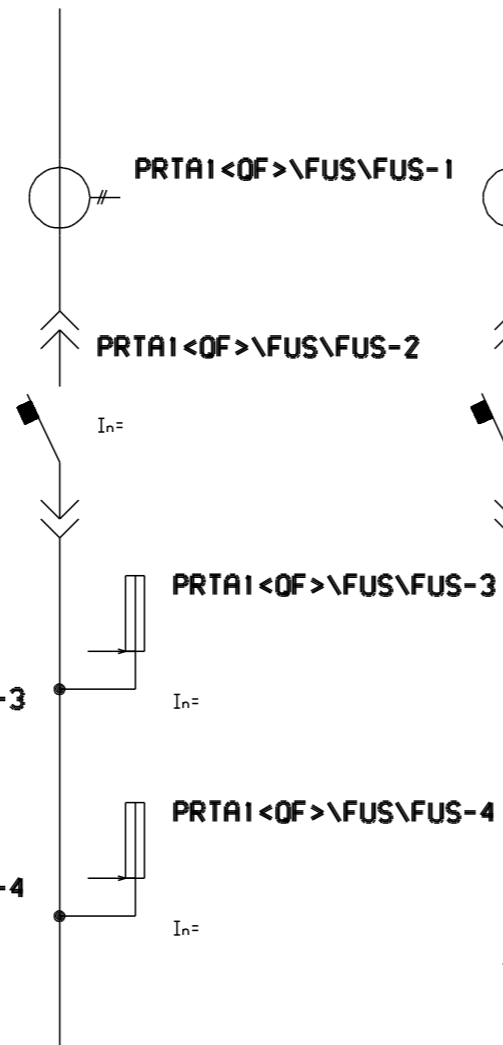
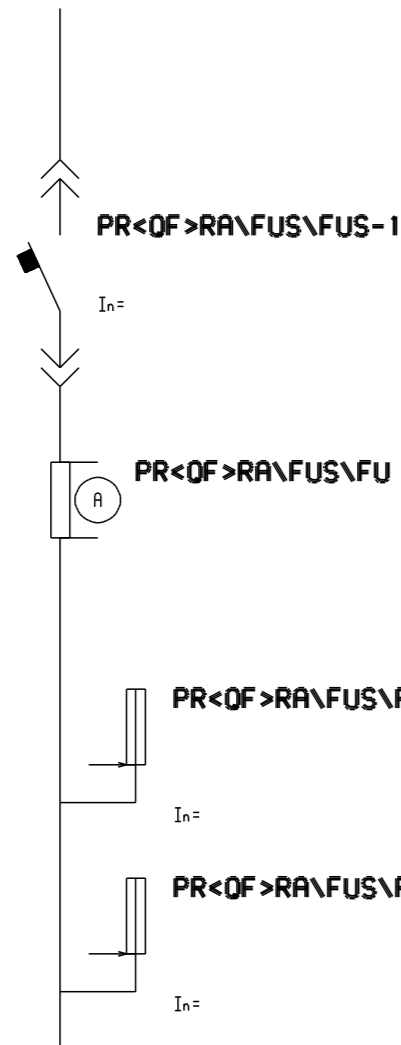
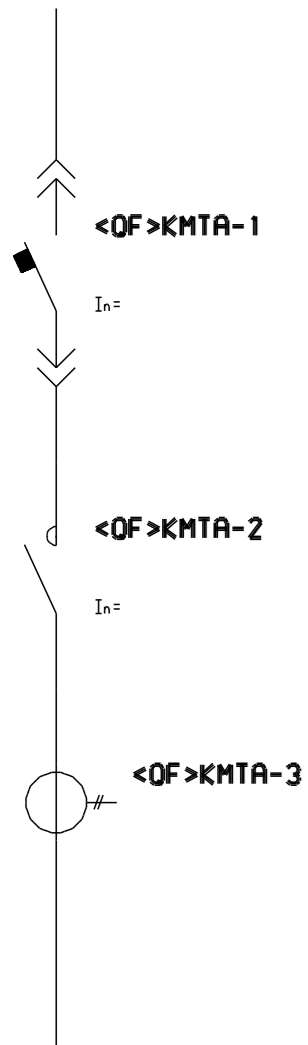

<OF>KMTAX\X

<OF>KMTAX\X

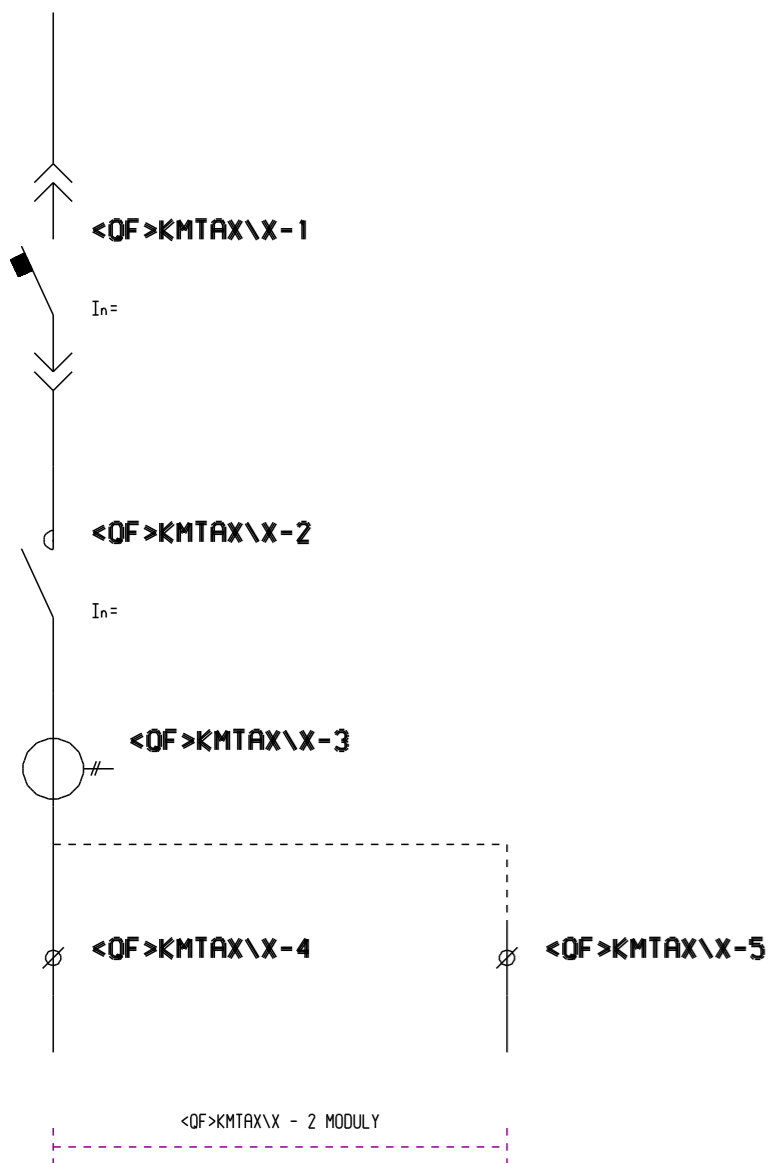

<OF>KMX\X

<OF>KMX\X

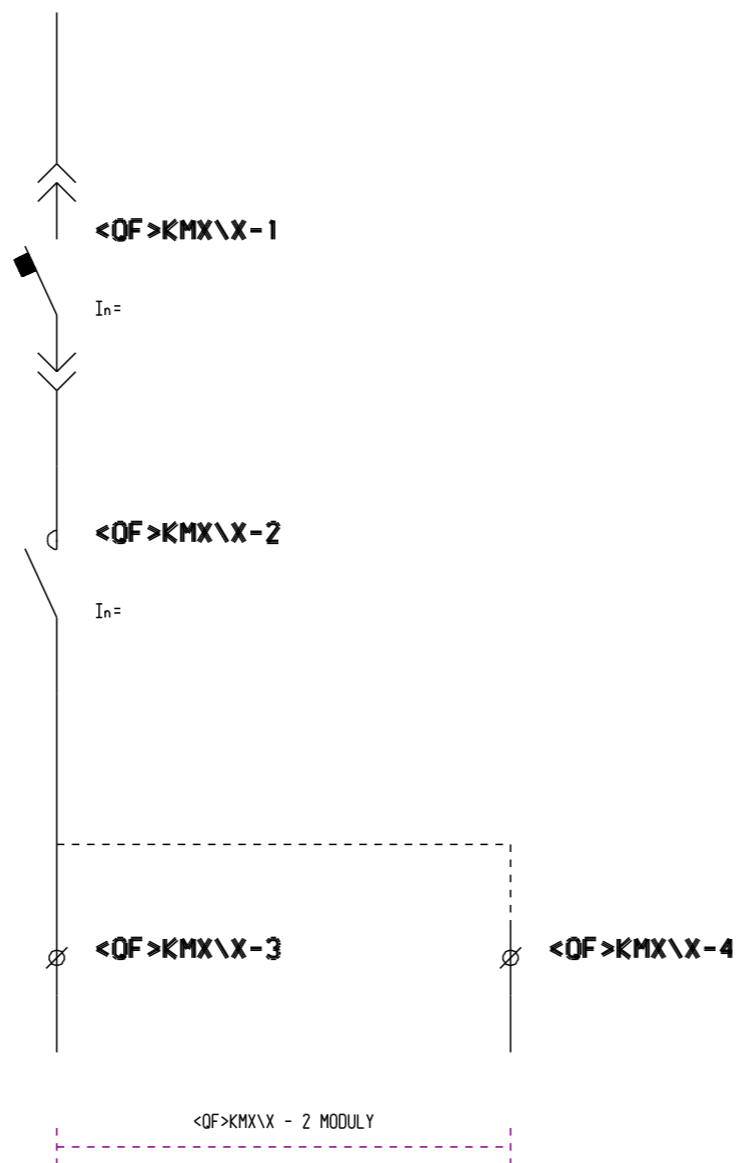

OFVKX\X

OFVKX\X

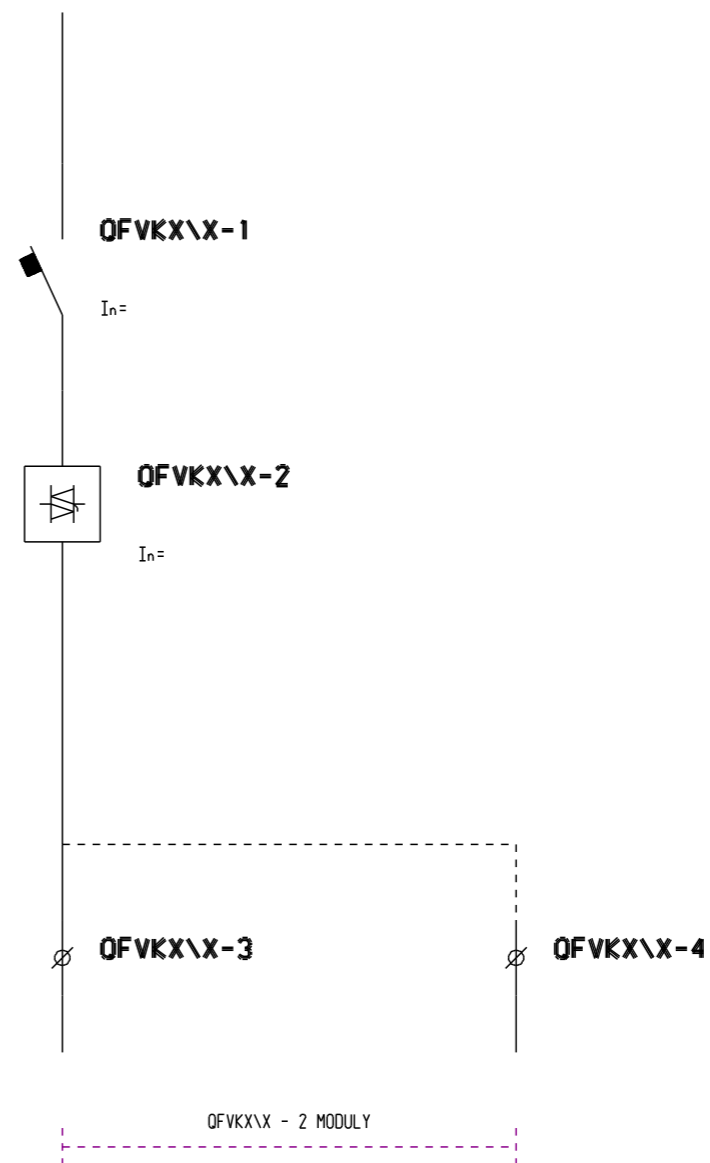

PR<OF>\FUSX

PR<OF>\FUSX

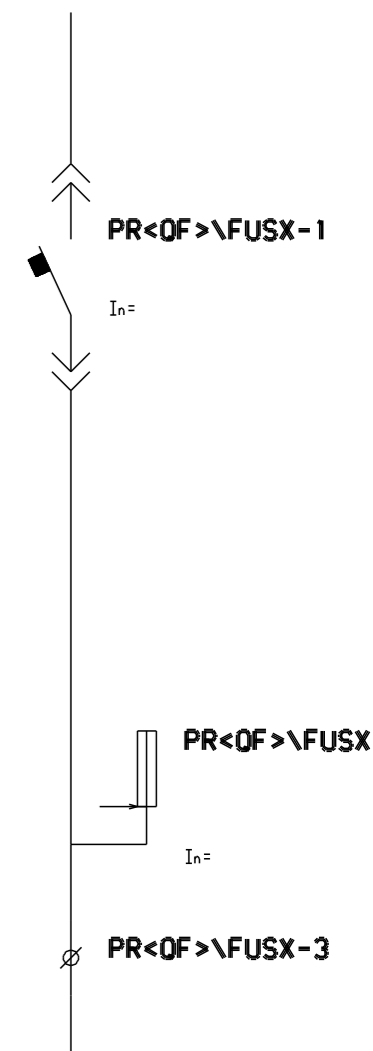

QFXBY60_3

QFXBY60_3

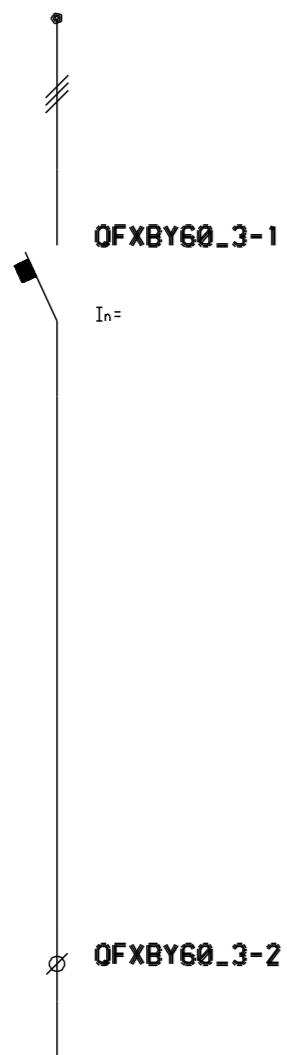

QFXBY60_3 - 2 MODULY

QFXBY60_1

QFXBY60_1

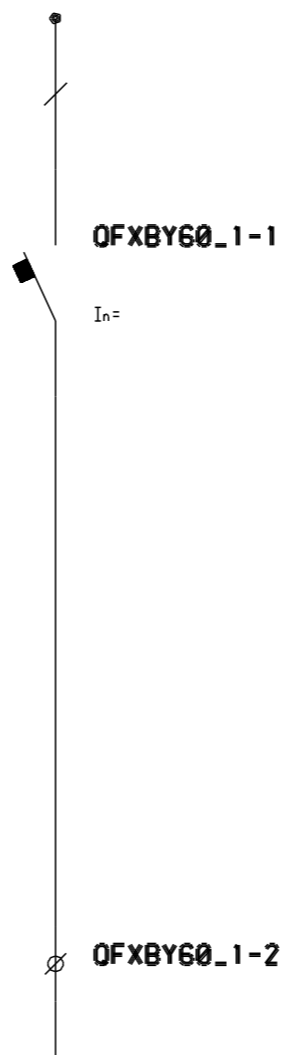

QFXBY60_1 - 2 MODULY

QFTA1KMXX

QFTA1KMXX

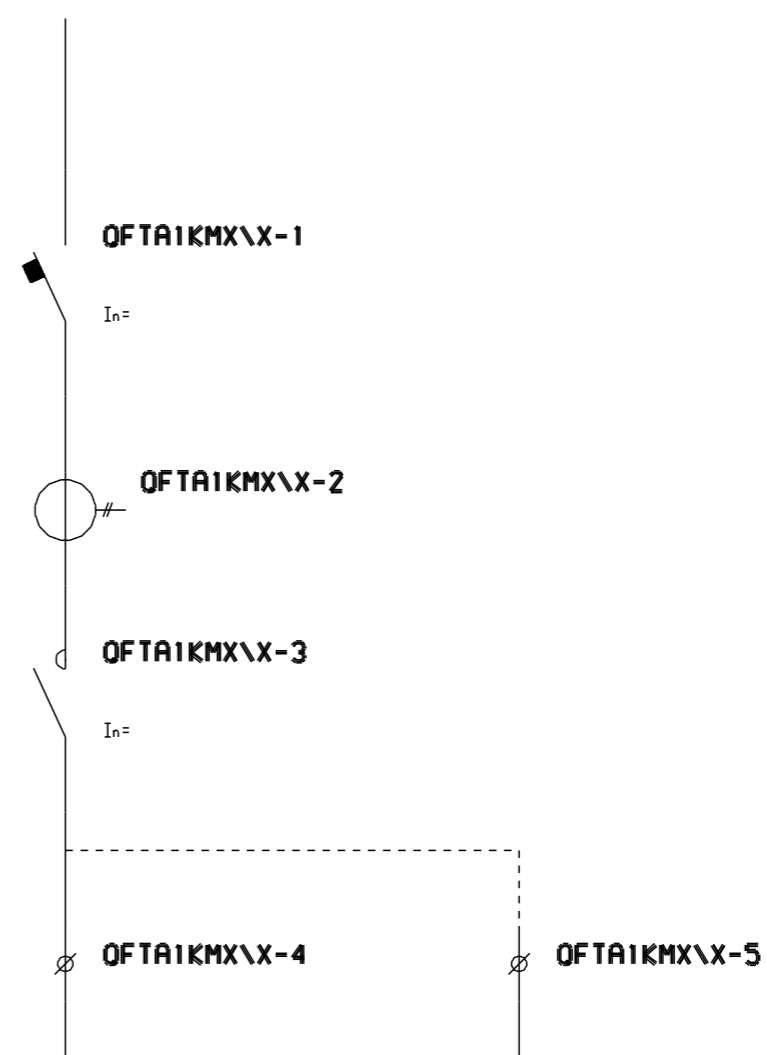

QFTA1KMXX - 2 MODULY

QFBY60_3

QFBY60_3

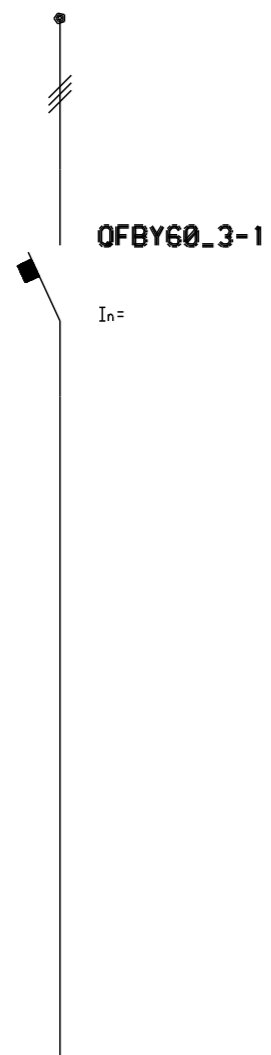

QFBY60_3 - 2 MODULY

QFBY60_1

QFBY60_1

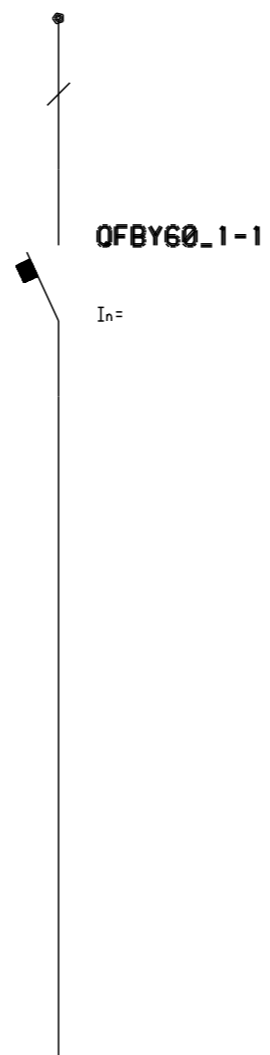

QFBY60_1 - 2 MODULY

PRTA30FX

PRTA30FX

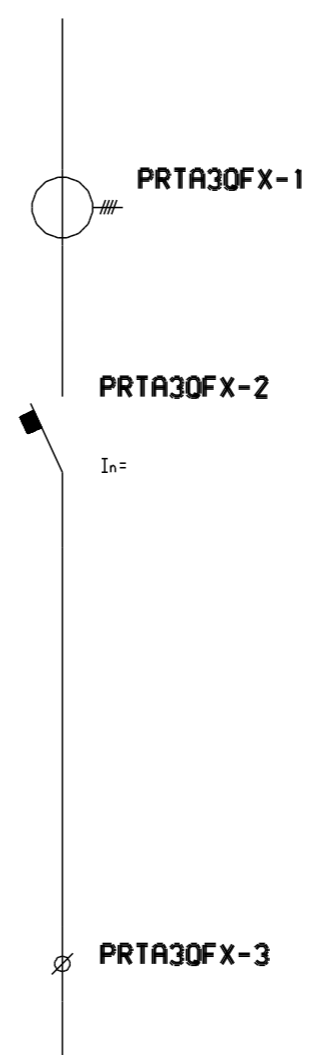

OFFIKMX

OFFIKMX

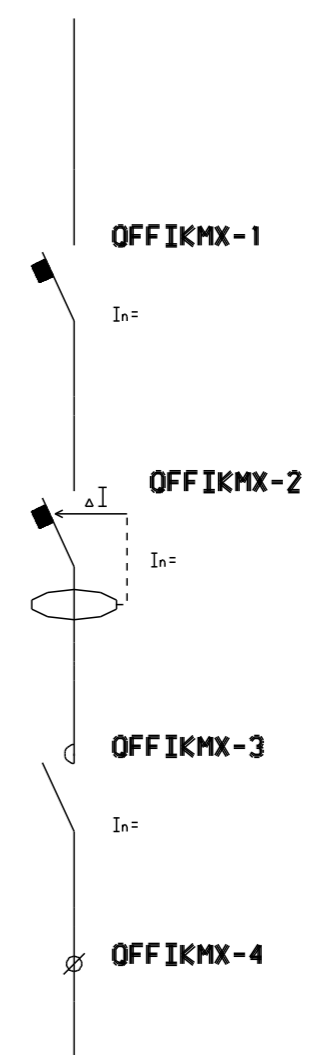

OFFIKMX\X

OFOMX

OFFIX1

OFKTX

OFNEZAPX

OFKT

OFFIKMX\X

OFOMX

OFFIX1

OFKTX

OFNEZAPX

OFKT

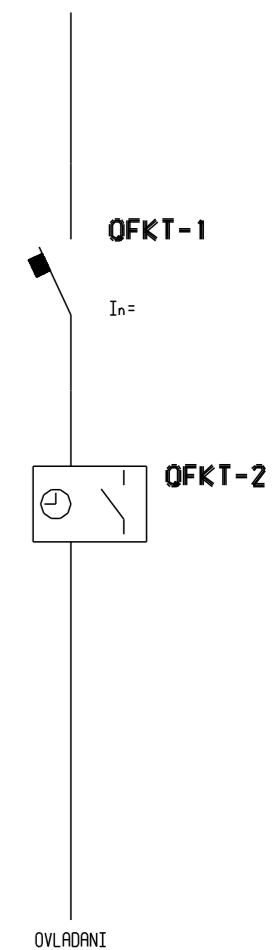
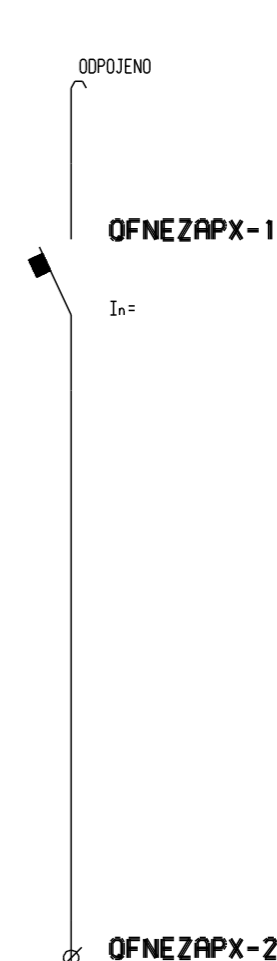
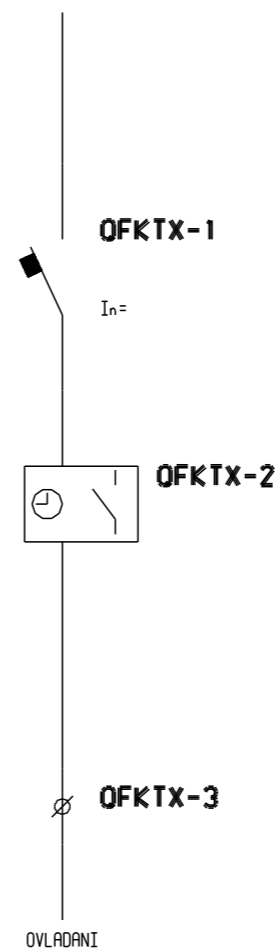
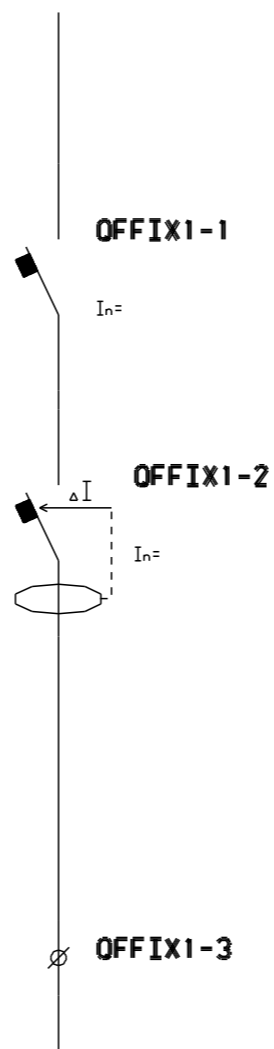
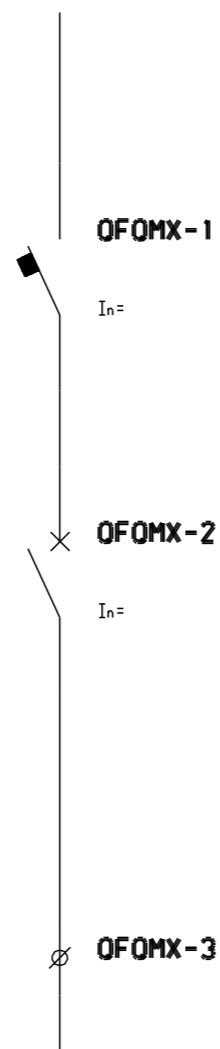
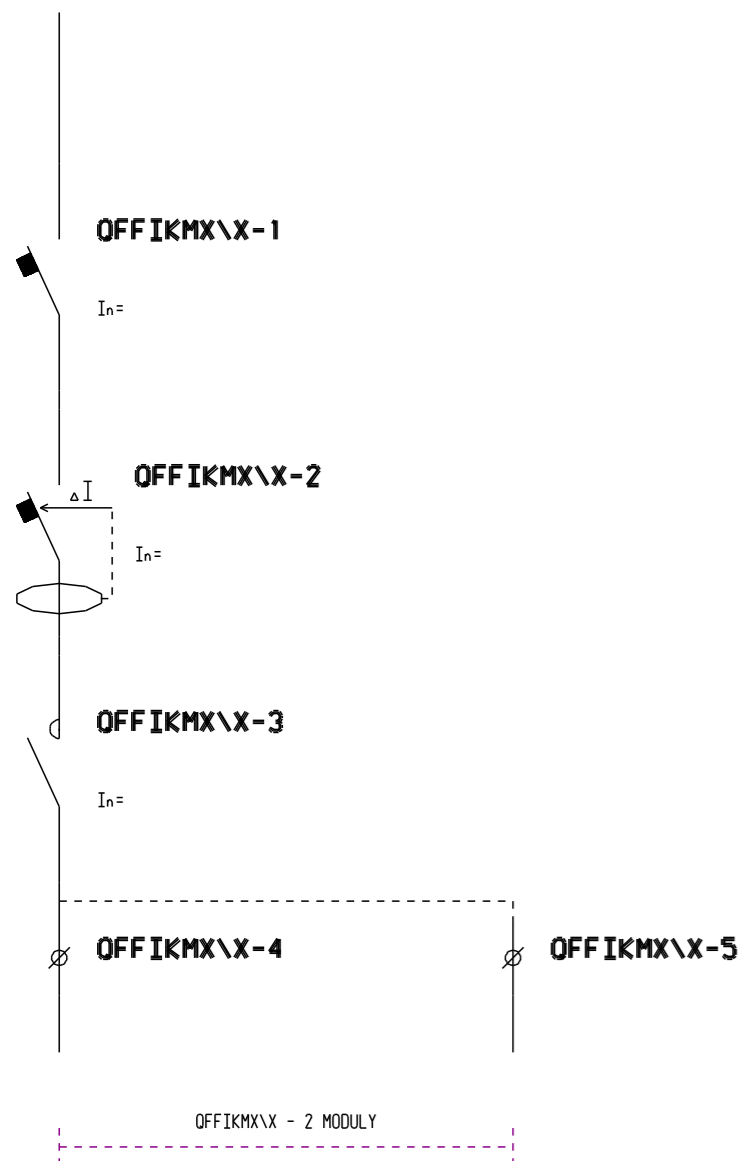

PRILOHA 2.1. TYPY ODBOCEK

ODBOCKY ZACINAJICI JISTICEM-70

<QF>KMFATA1X\X

<QF>KMFAX\X

QFQF3X3

<QF>KMFATA1X\X

<QF>KMFAX\X

QFQF3X3

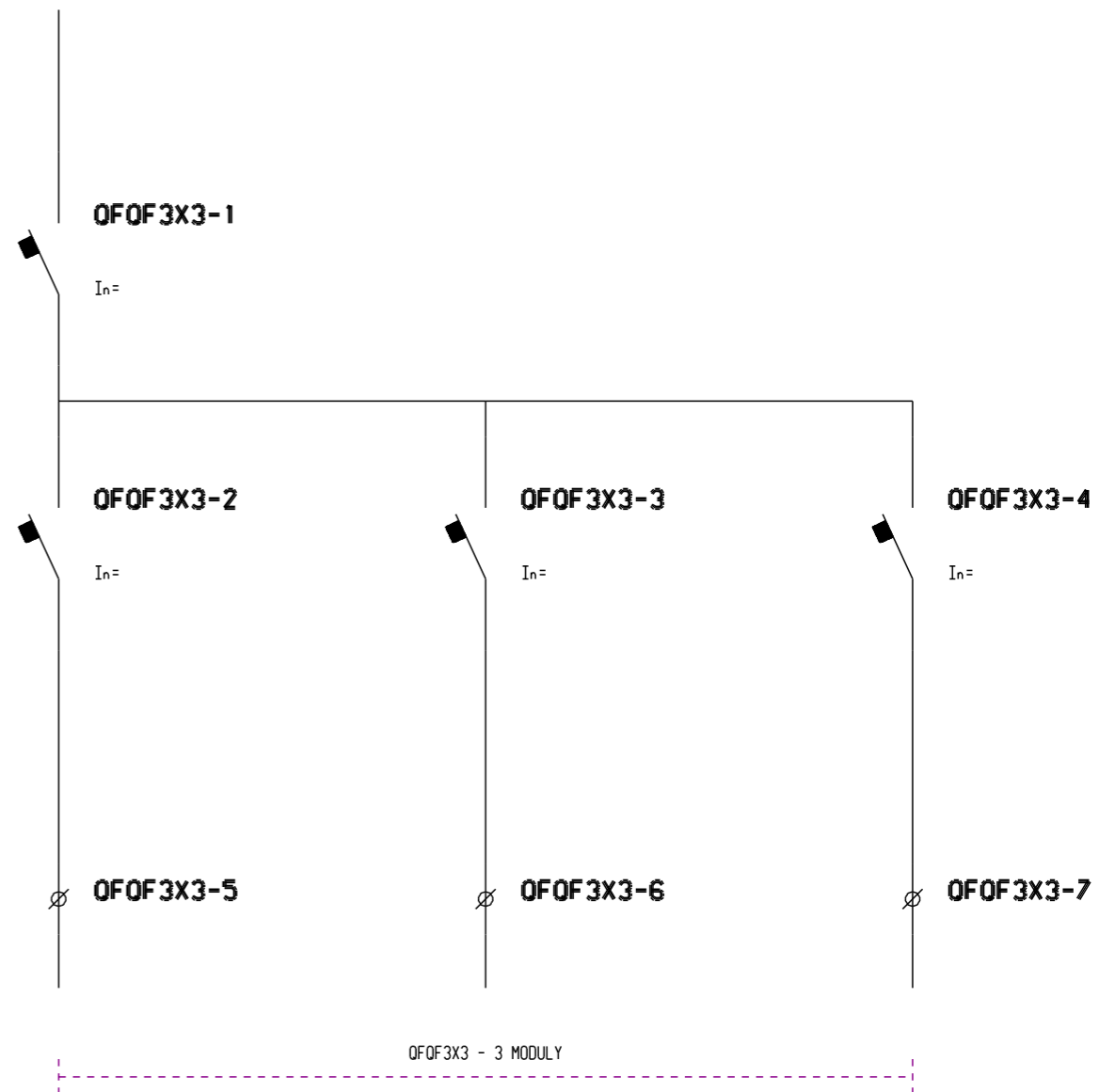
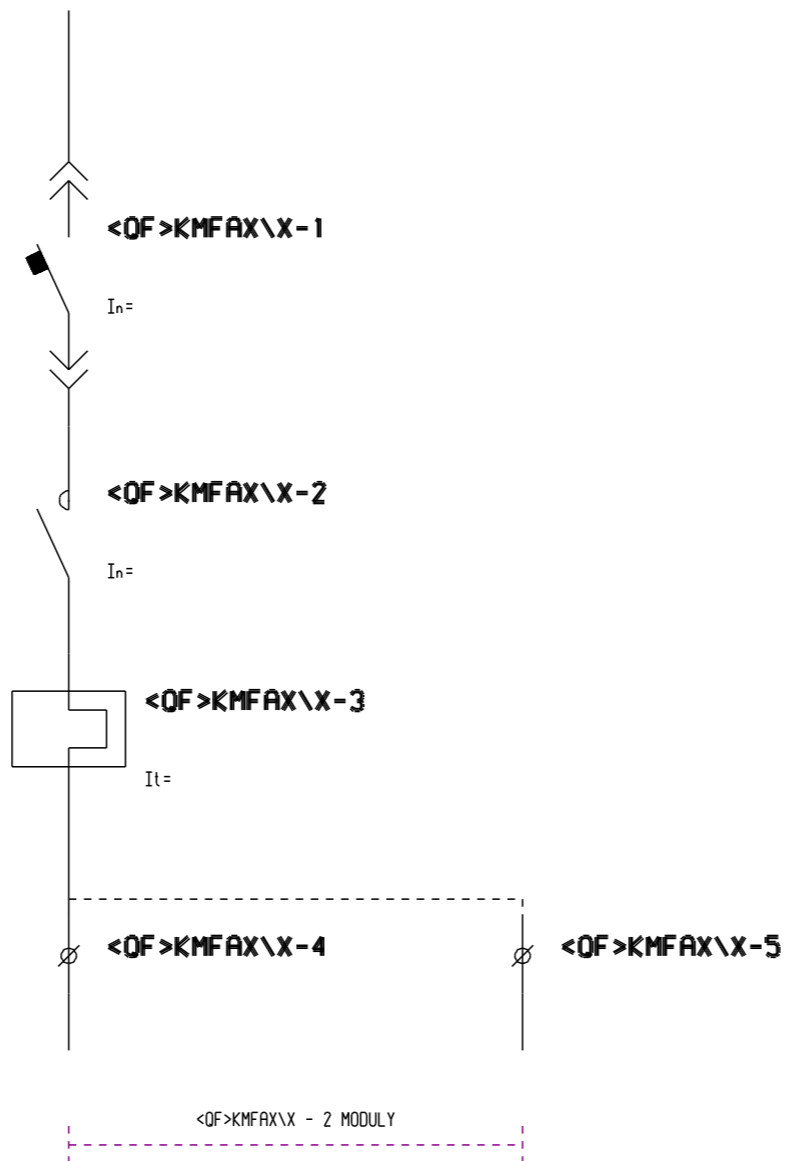
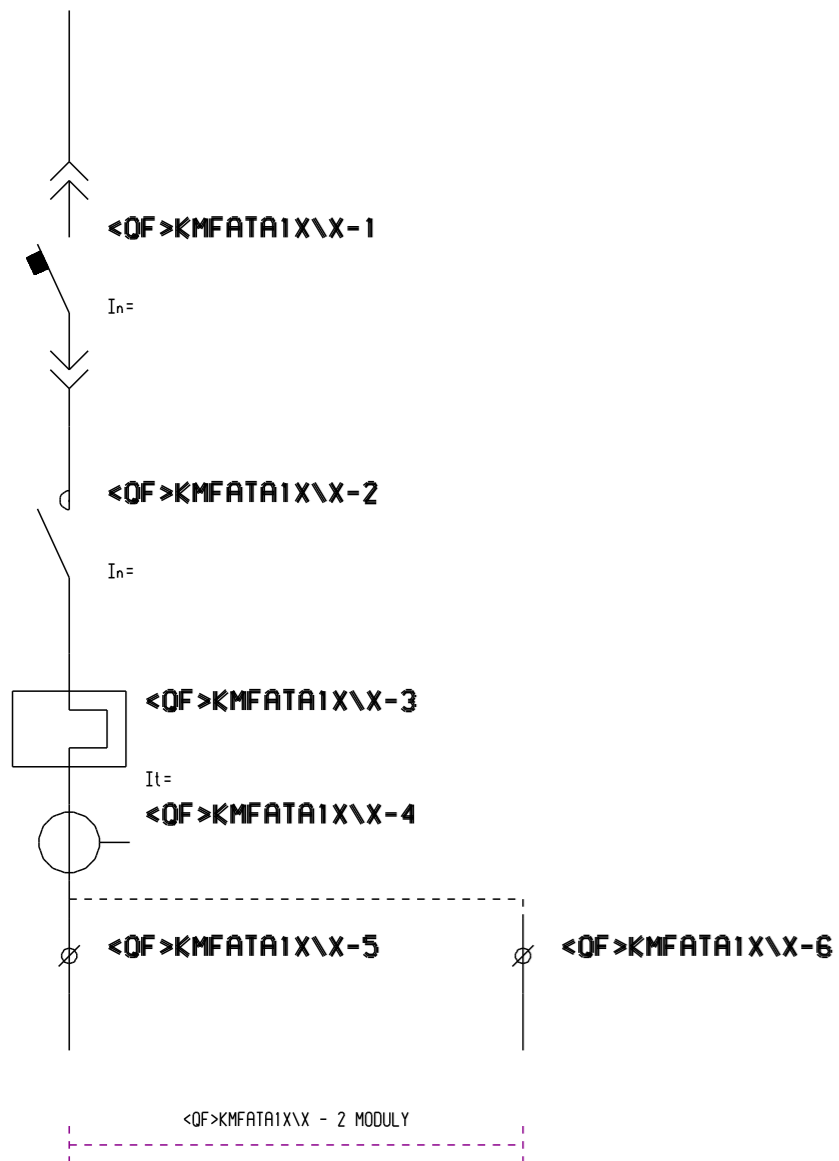

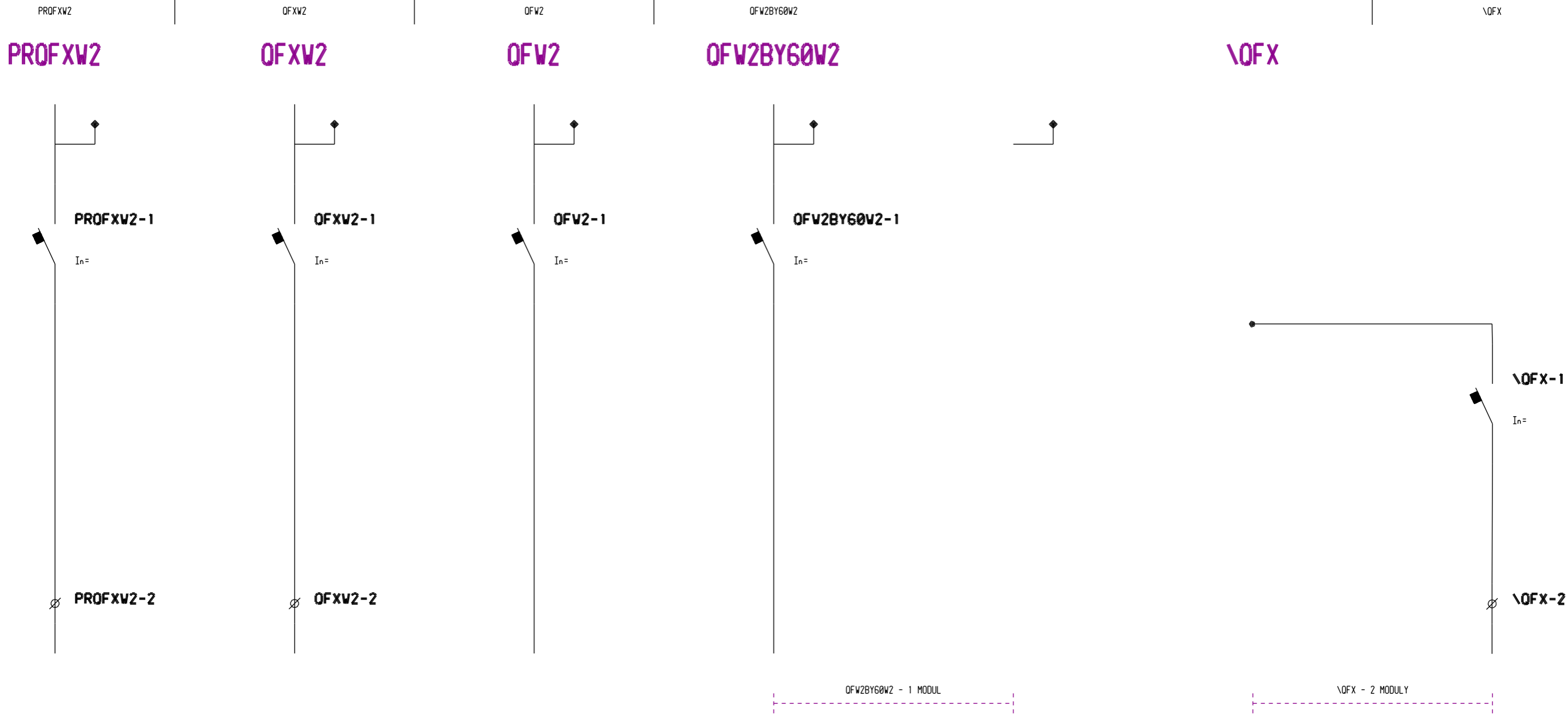

OFOMX\X

OFOMX\X

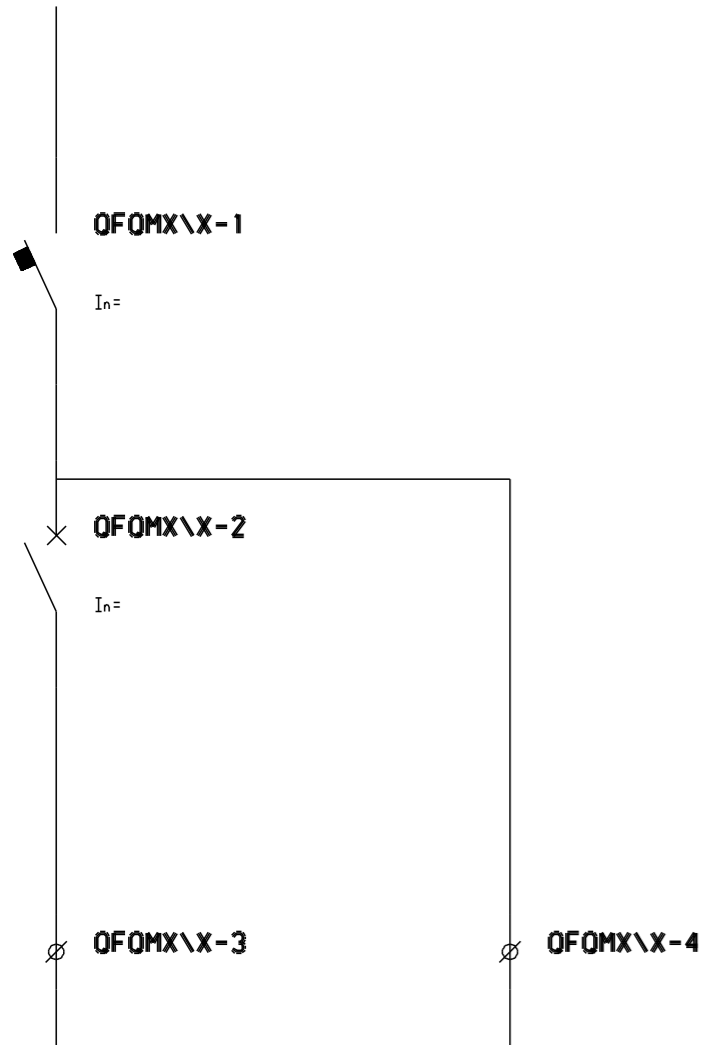

OFOMX\X - 2 MODULY

OFX\OMX

OFX\OMX

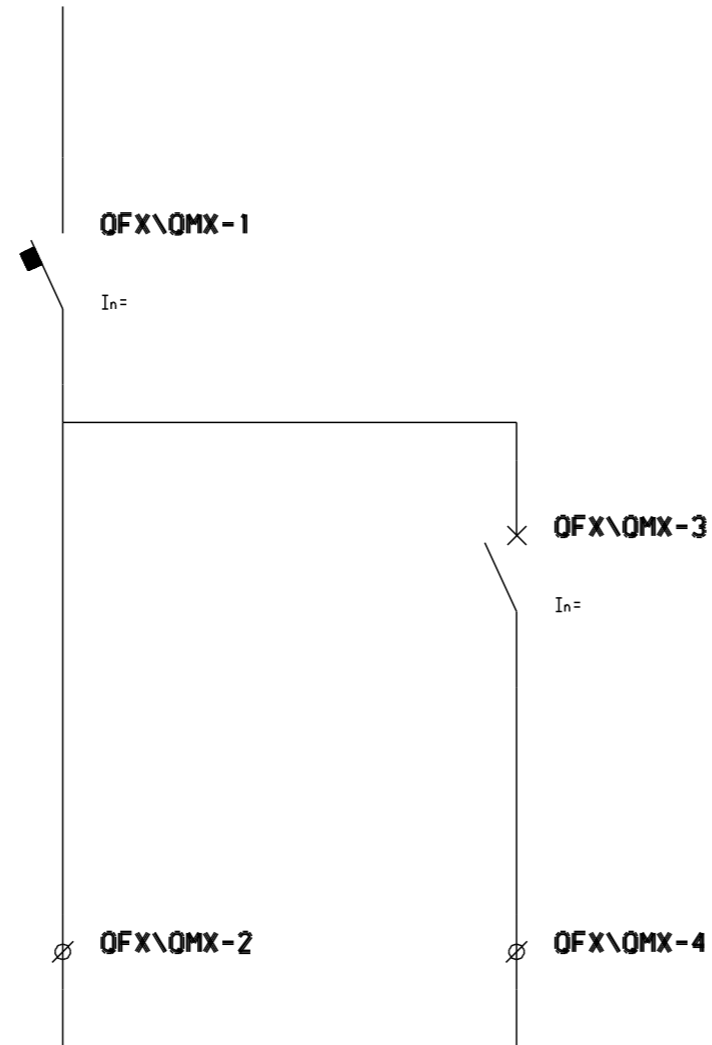

OFX\OMX - 2 MODULY

PR<OF>\OSFX

PR<OF>\OSFX

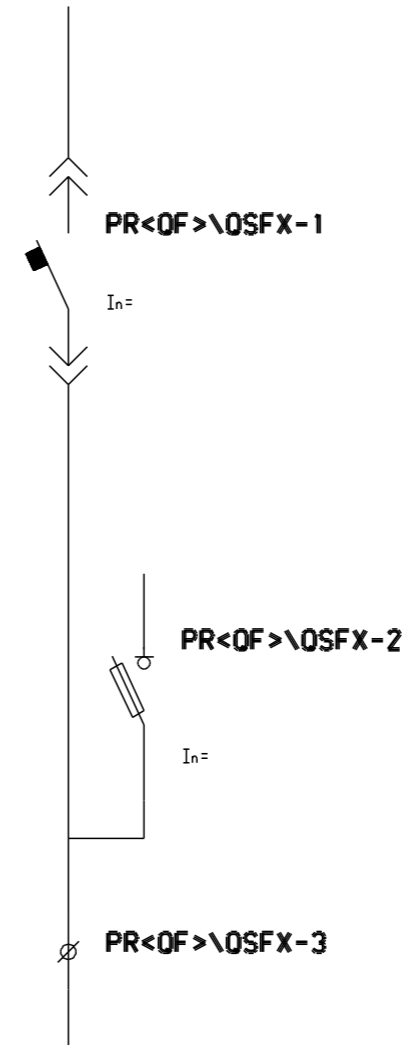

OFKMX\OFOVL

OFKMX\OFOVL

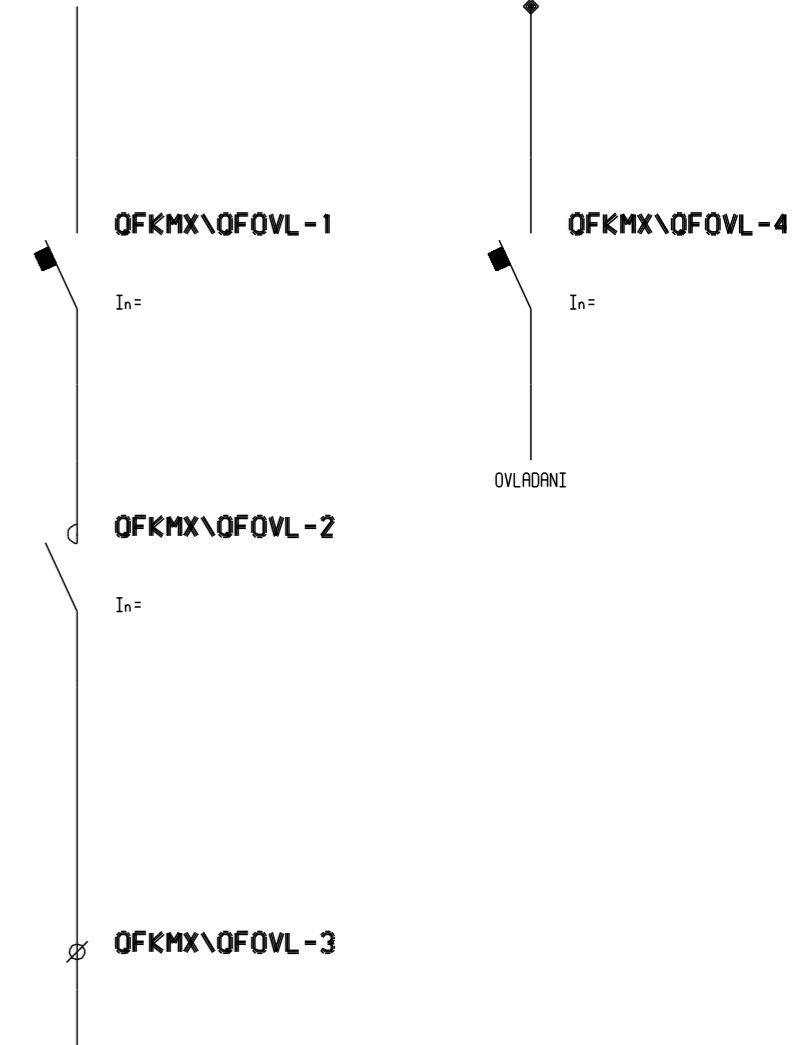

OFKMX\OFOVL - 2 MODULY

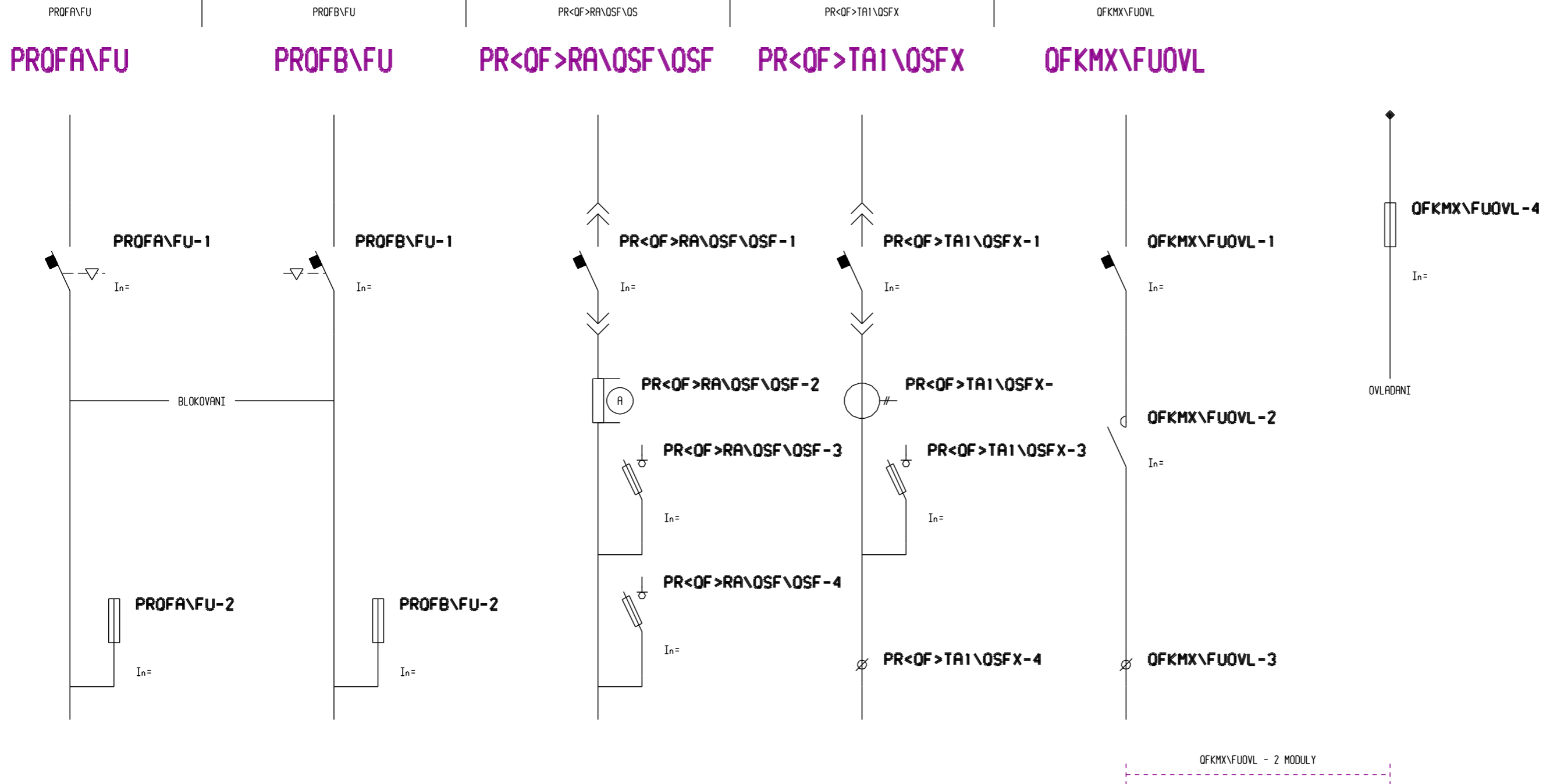

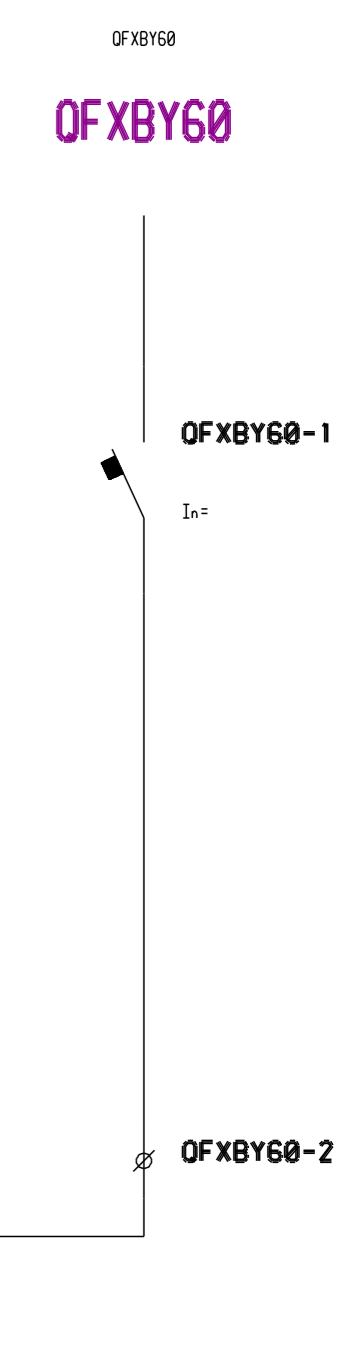
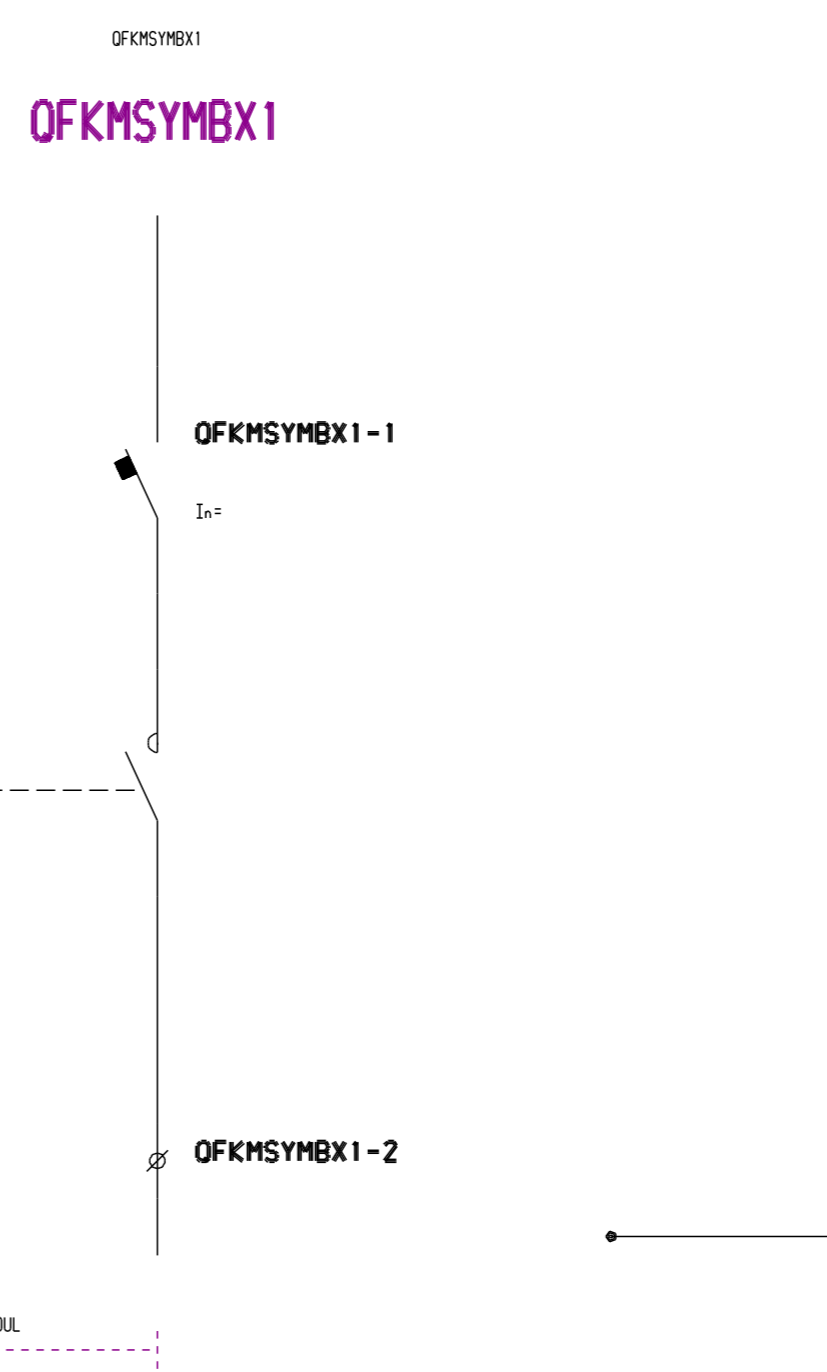
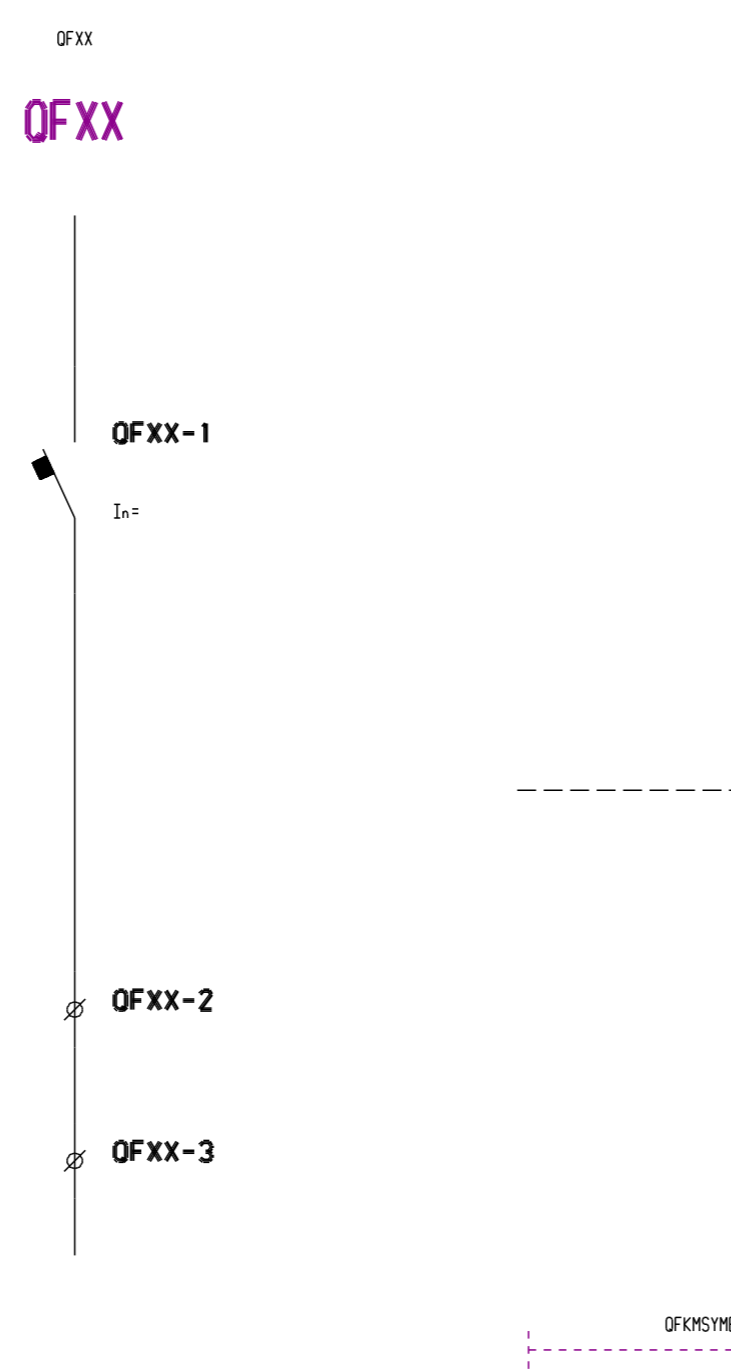
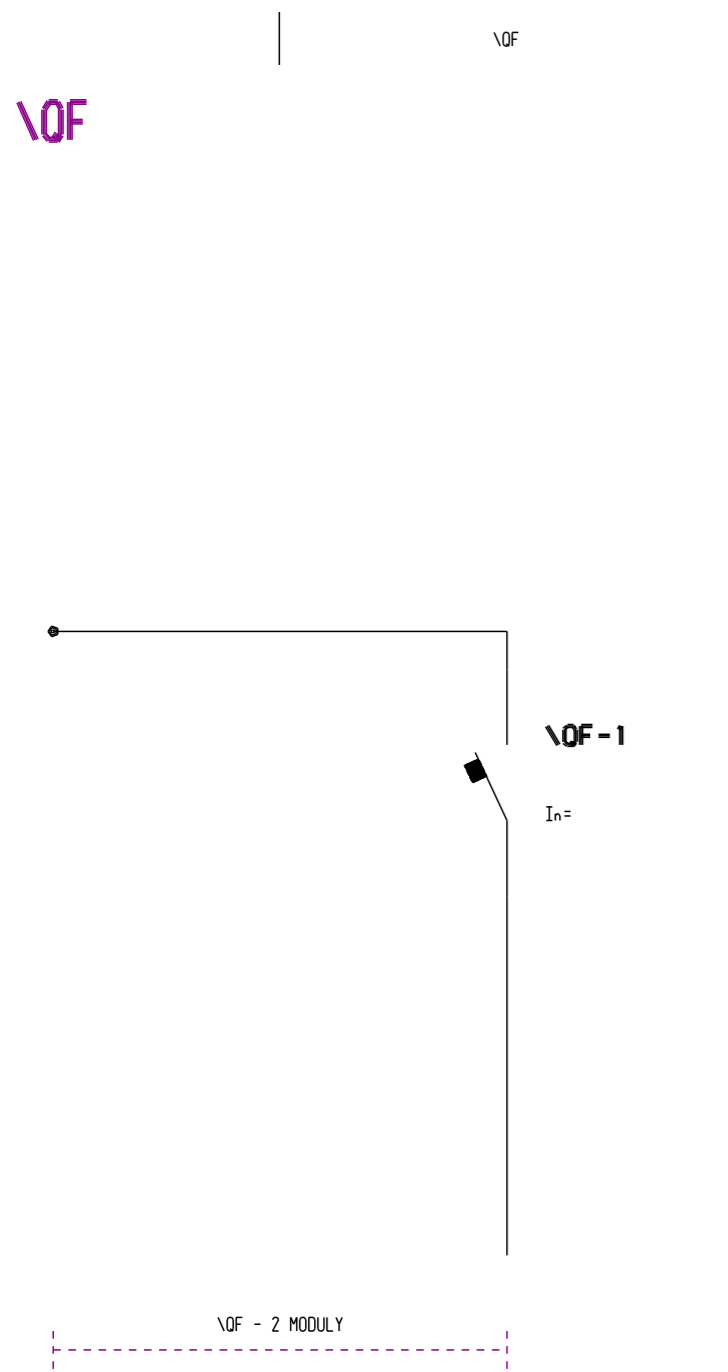

PROFX\QF | \QF\FUOVLBY120

PROFX\QF | **\QF\FUOVLBY120**

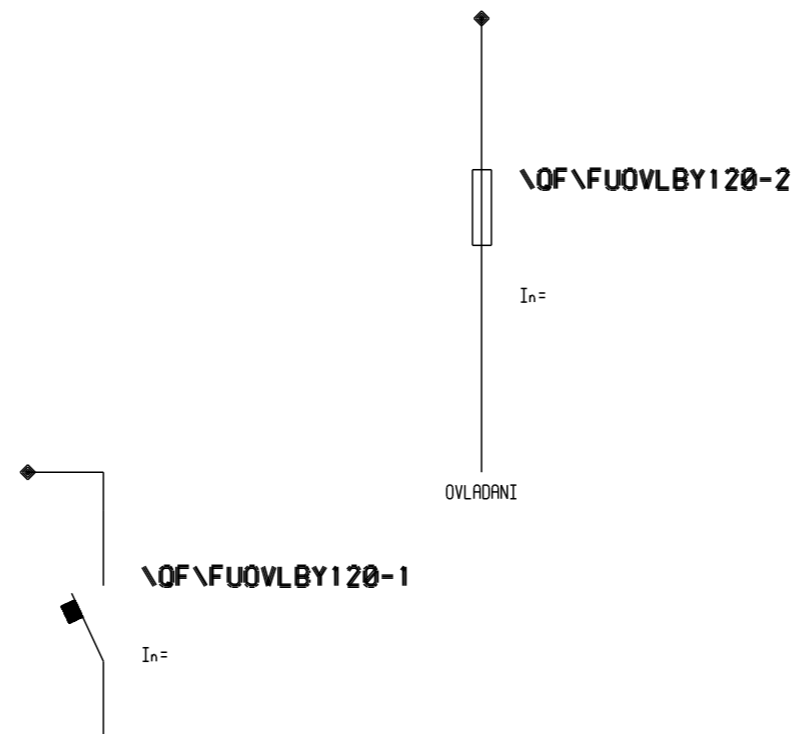
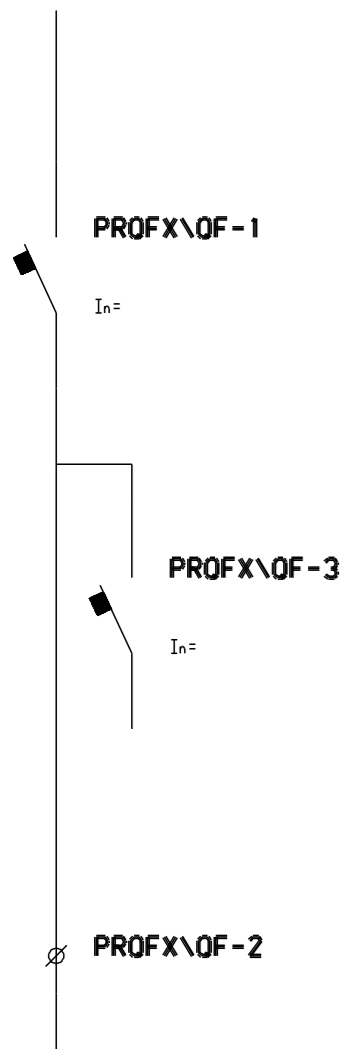

\QF\FUOVLBY120 - 1 MODUL

**PRIVODNI ODBOCKA
MUSI MIT SIRKU 2 MODULY**

PROF\QFOFX | QFTOFX

PROF\QFOFX | **QFTOFX**

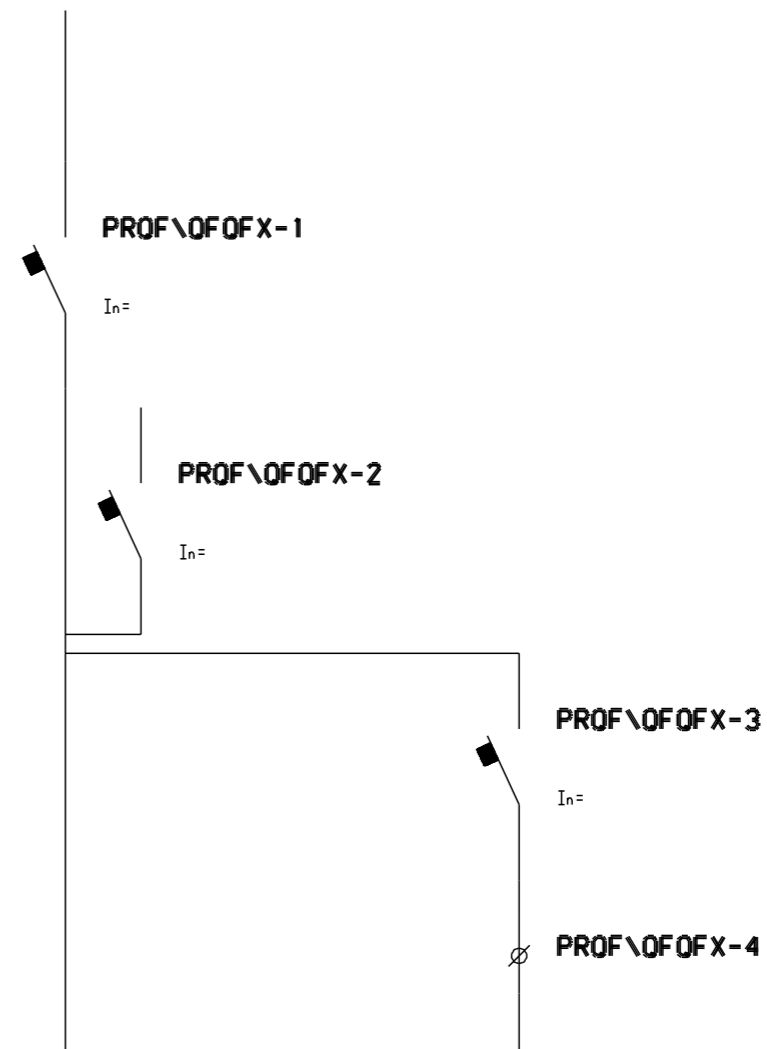

QPROF\QFOFX - 2 MODULY

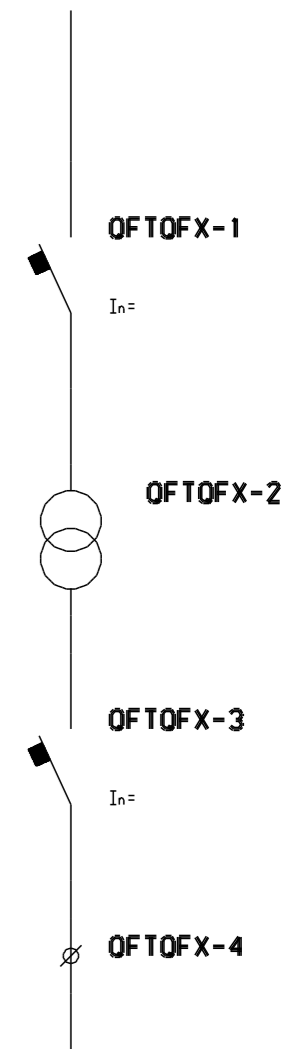

**PRILOHA 2.1. TYPY ODBOCEK
ODBOCKY ZACINAJICI JISTICEM-76**

OFFV2

OFFV2

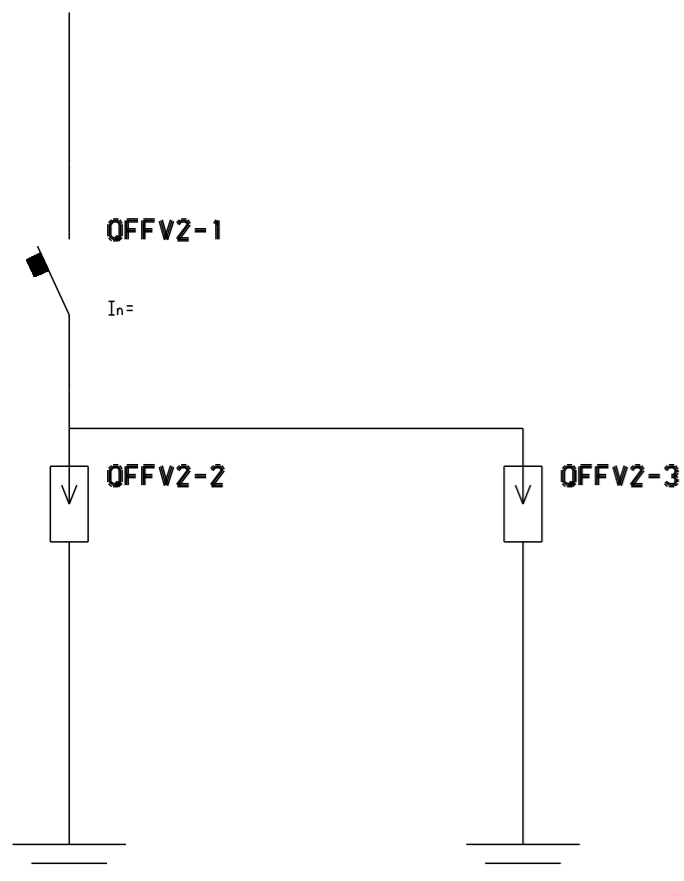

OFFV2 - 2 MODULY

OFKMX\QFOVL1

OFKMX\QFOVL1

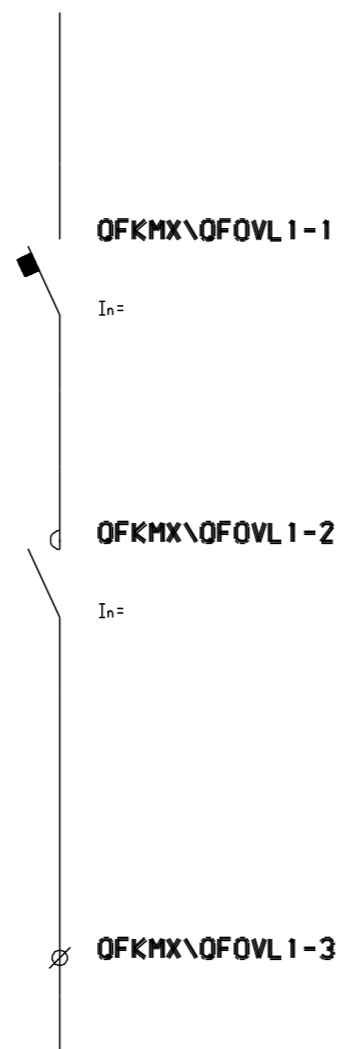

OFKMX\QFOVL1 - 3 MODULY

QFKMSYMBX2

QFKMSYMBX2

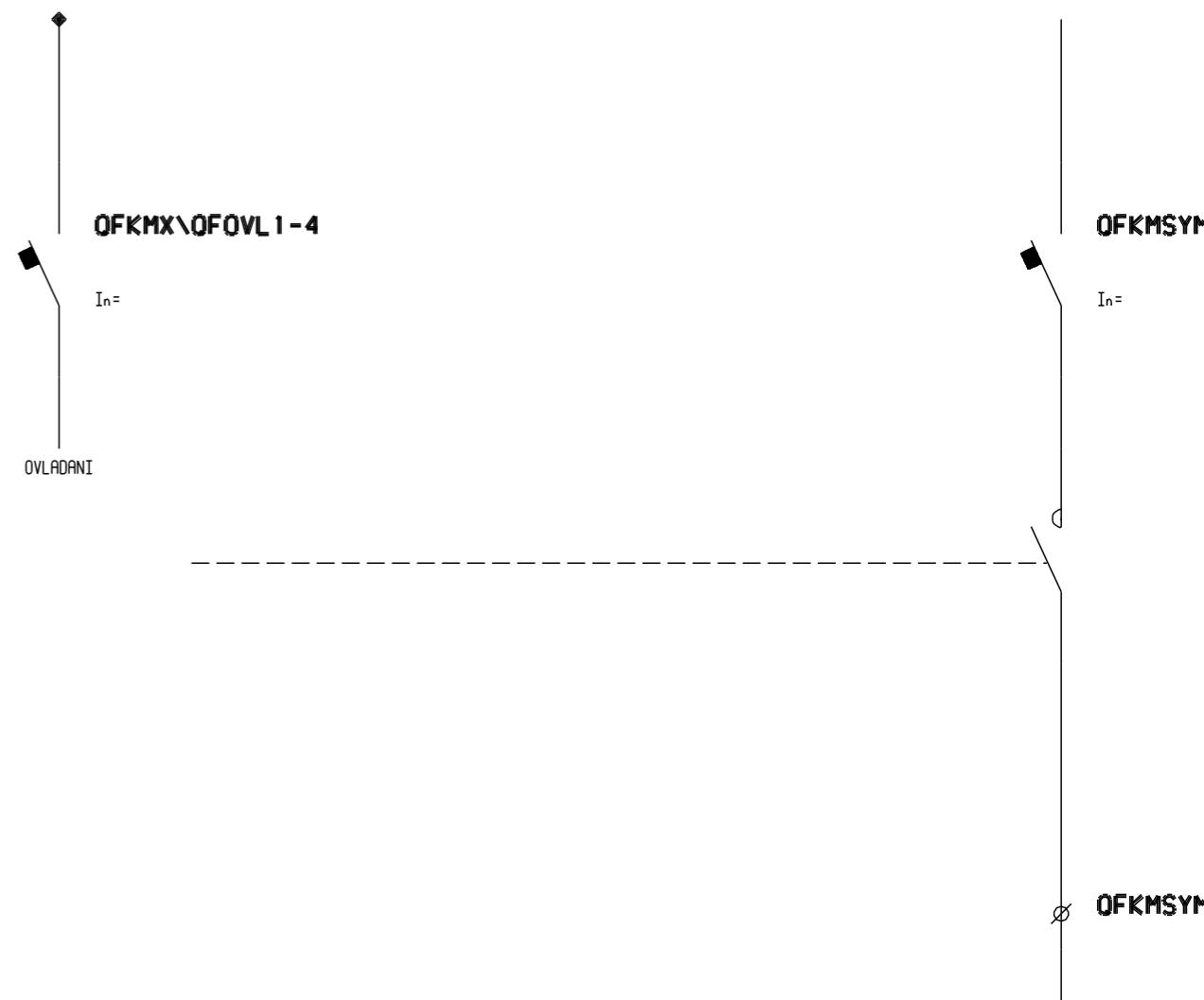

OFFV2 - 2 MODULY

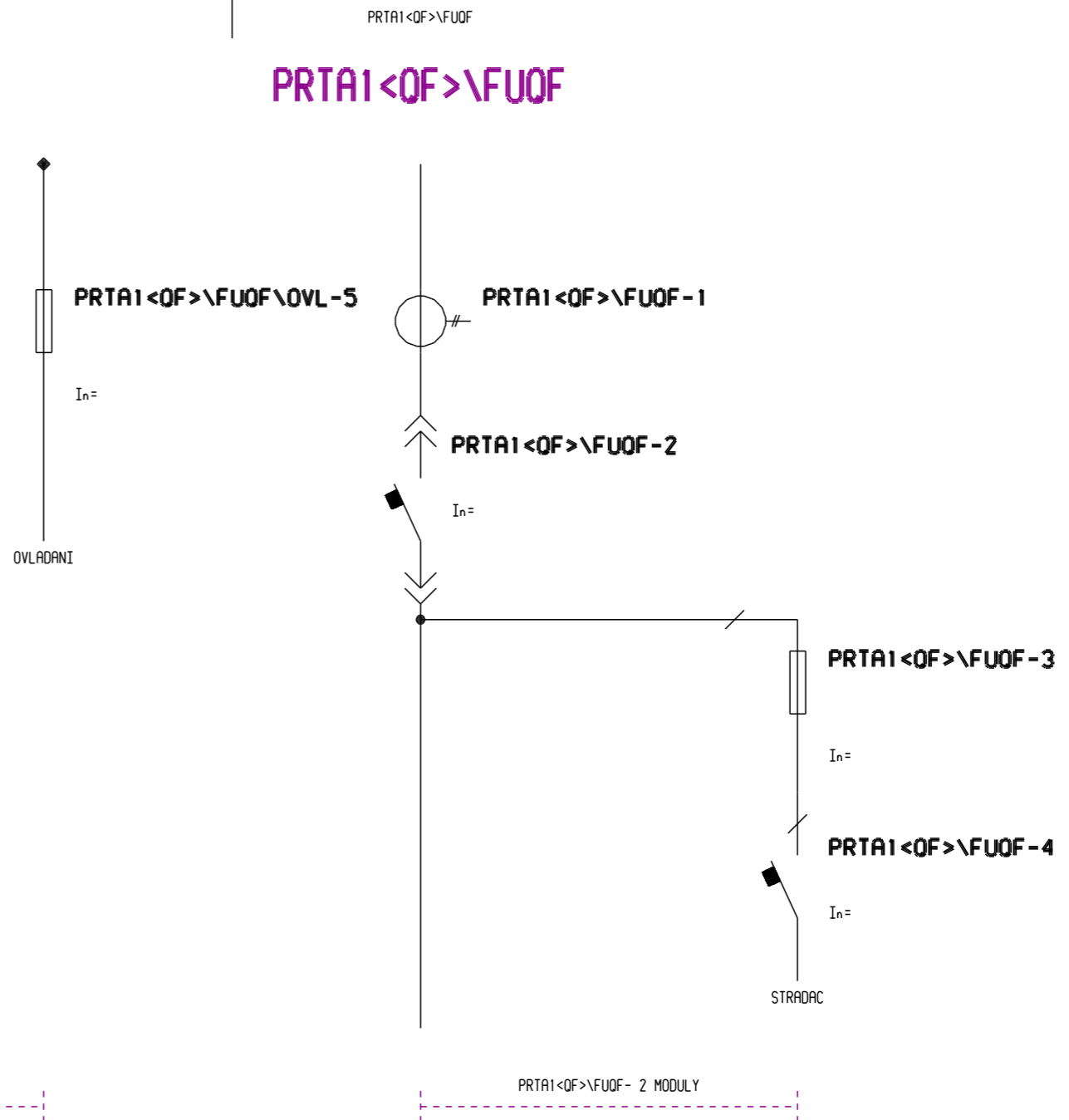
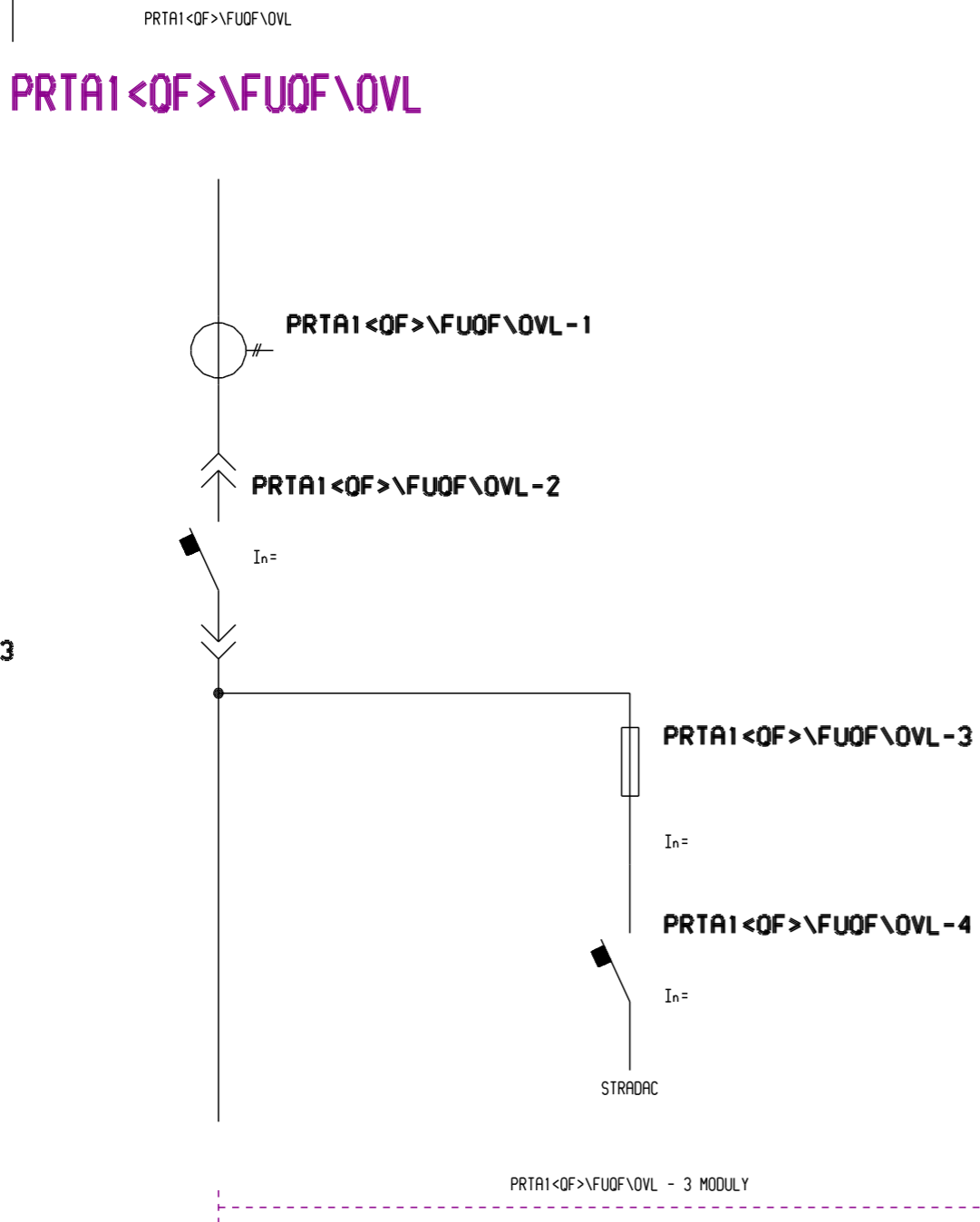
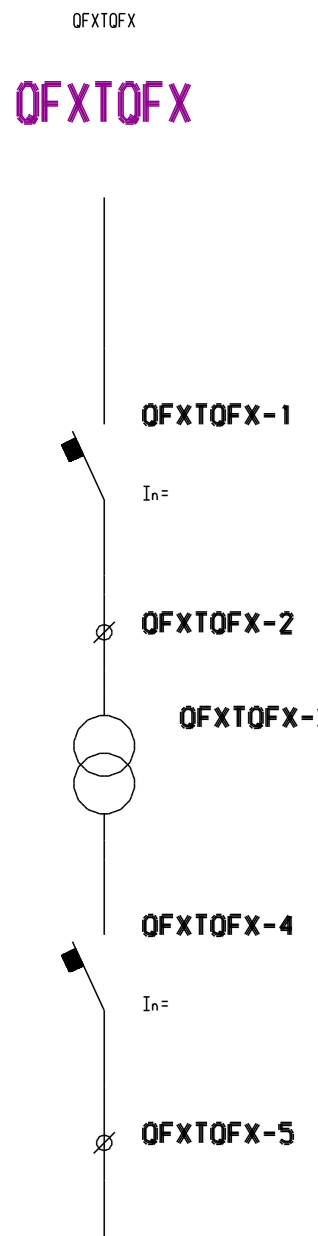

OFXBY120
OFXBY120

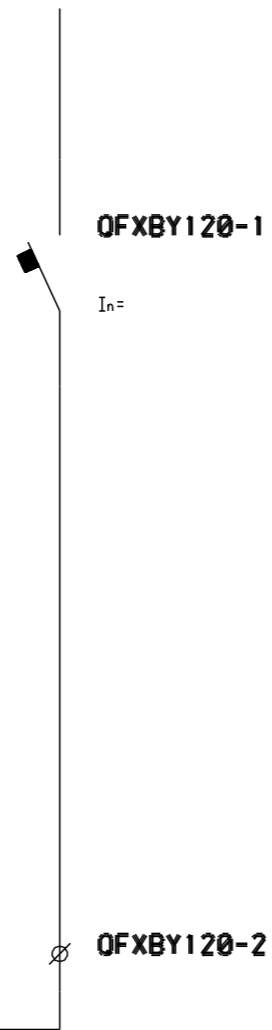

OFXBY120 - 1 MODUL

OFX\FV
OFX\FV

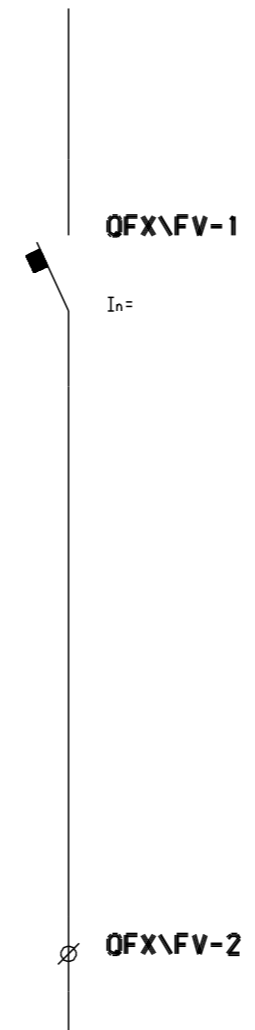

OFX\FV - 2 MODULY

OFX\FV1
OFX\FV1

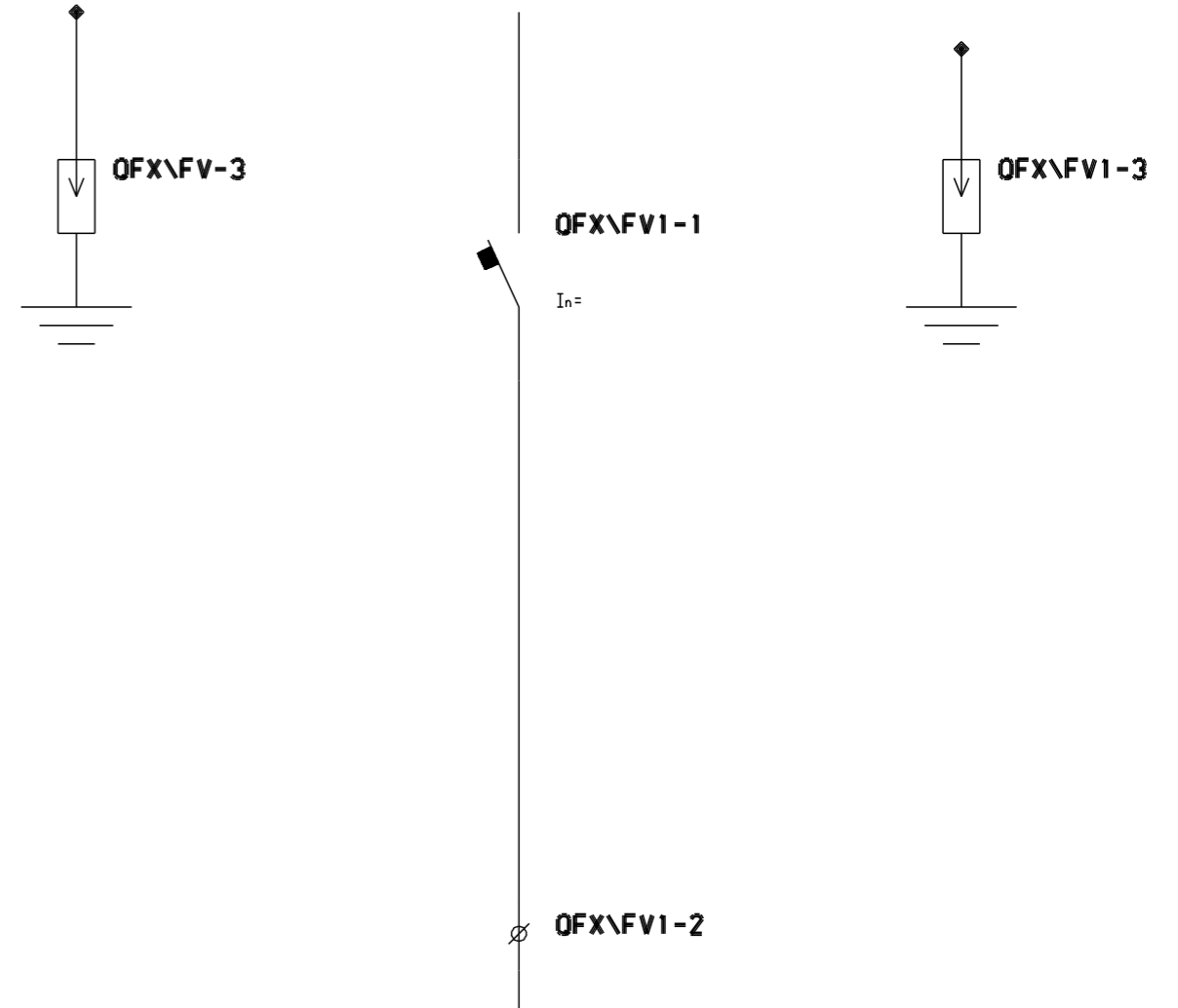

OFX\FV1 - 2 MODULY

OFKMX\OFOVL2

OF3KMX3_1\OFOVL

OFOMKAX

OFKMX\OFOVL2

OF3KMX3_1\OFOVL

OFOMKAX

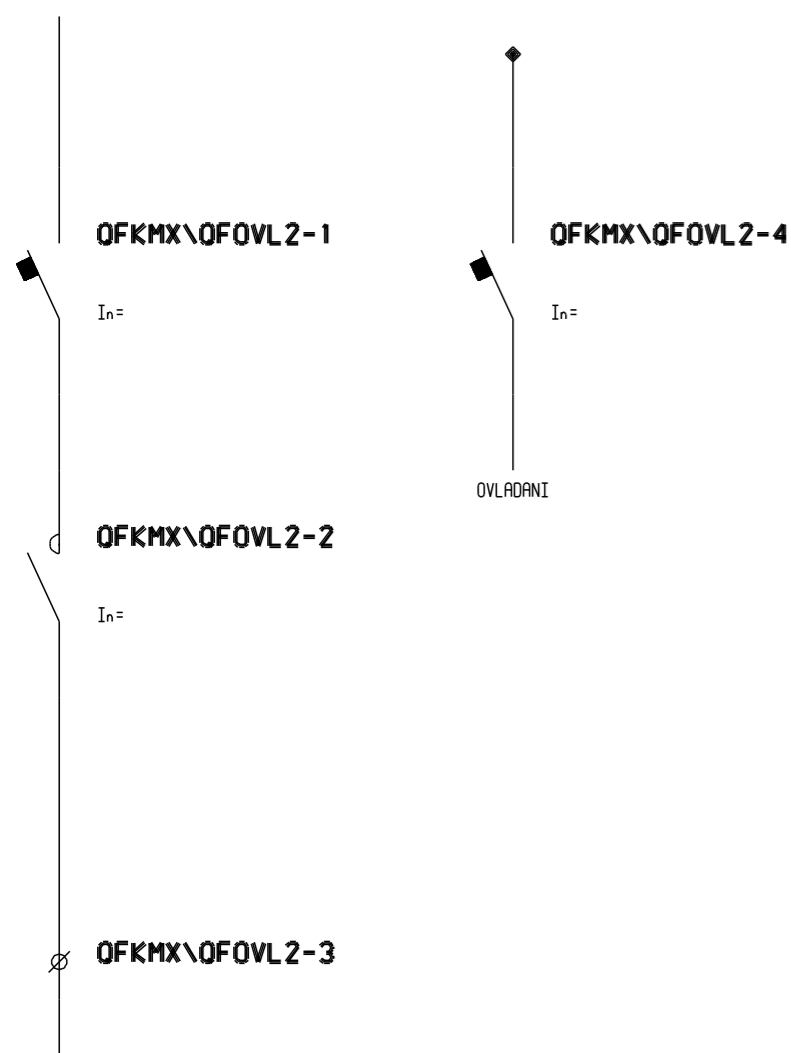

OFXBY120 - 1 MODUL

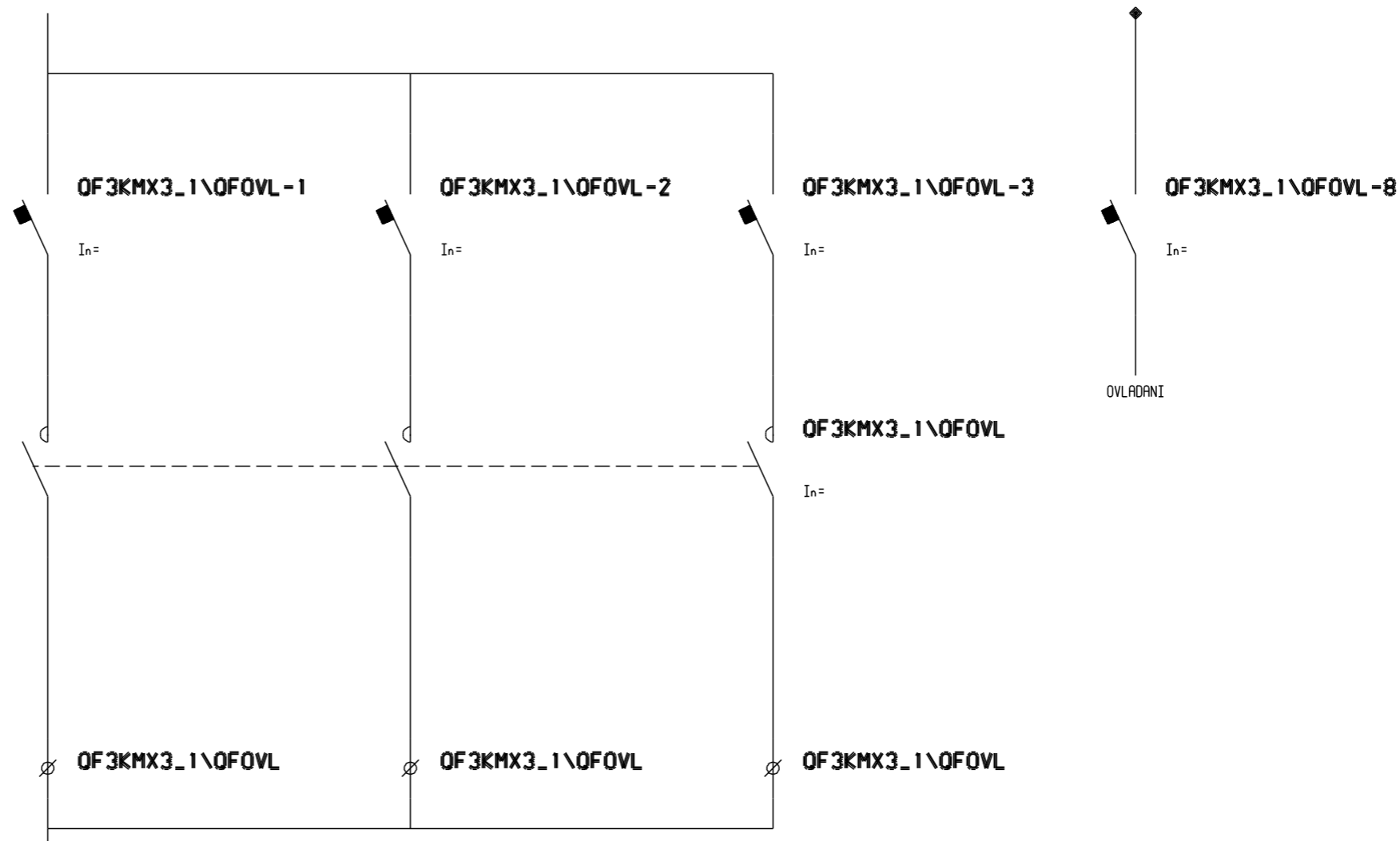

OF3KMX3_1\OFOVL - 4 MODULY

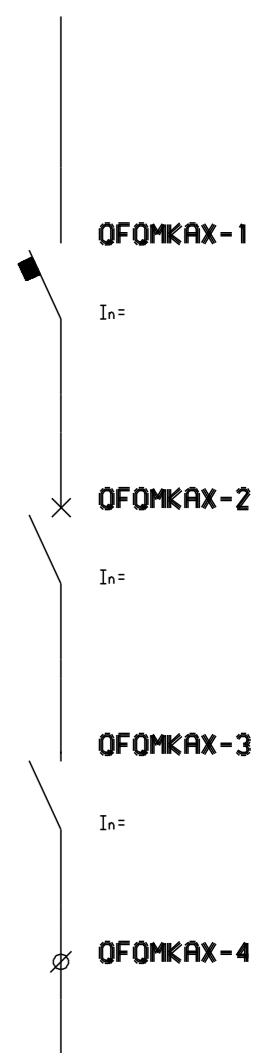

JISTIC OVLADANI NAPAJEN Z PRIPOJNICE WP

PRILOHA 2.1. TYPY ODBOCEK ODBOCKY ZACINAJICI JISTICEM-80

OFFUX

OFFUX

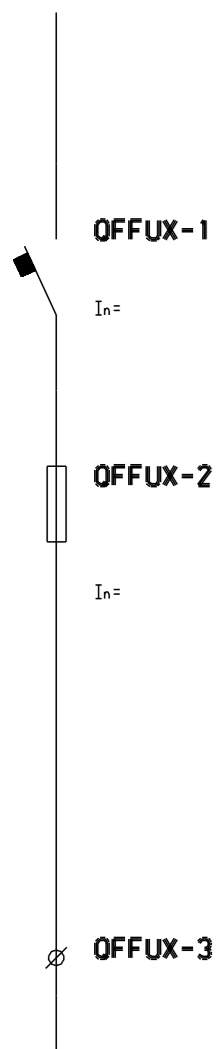

PROF\QFOVL

PROF\QFOVL

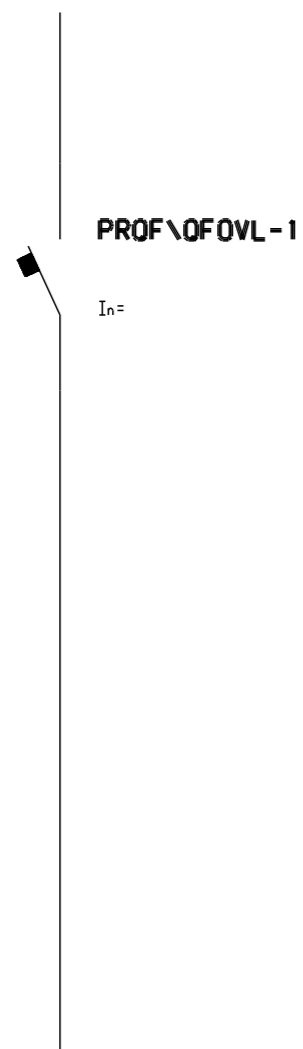

PROF\QFOVL - 2 MODULY

PROF\SBOVL

PROF\SBOVL

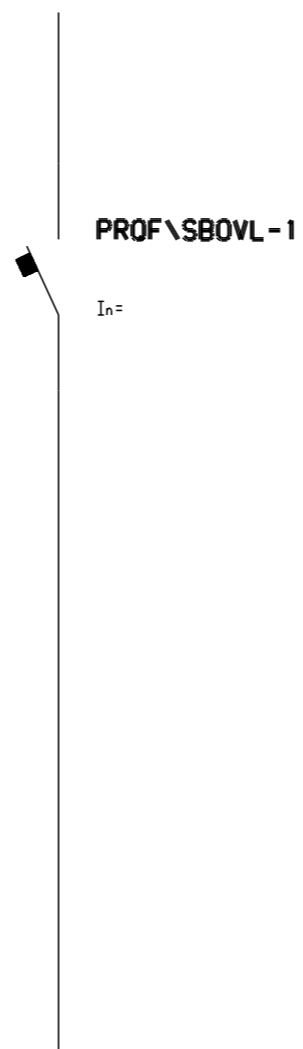

PROF\SBOVL - 2 MODULY

PRTA\QFOF

PRTA\QFOF

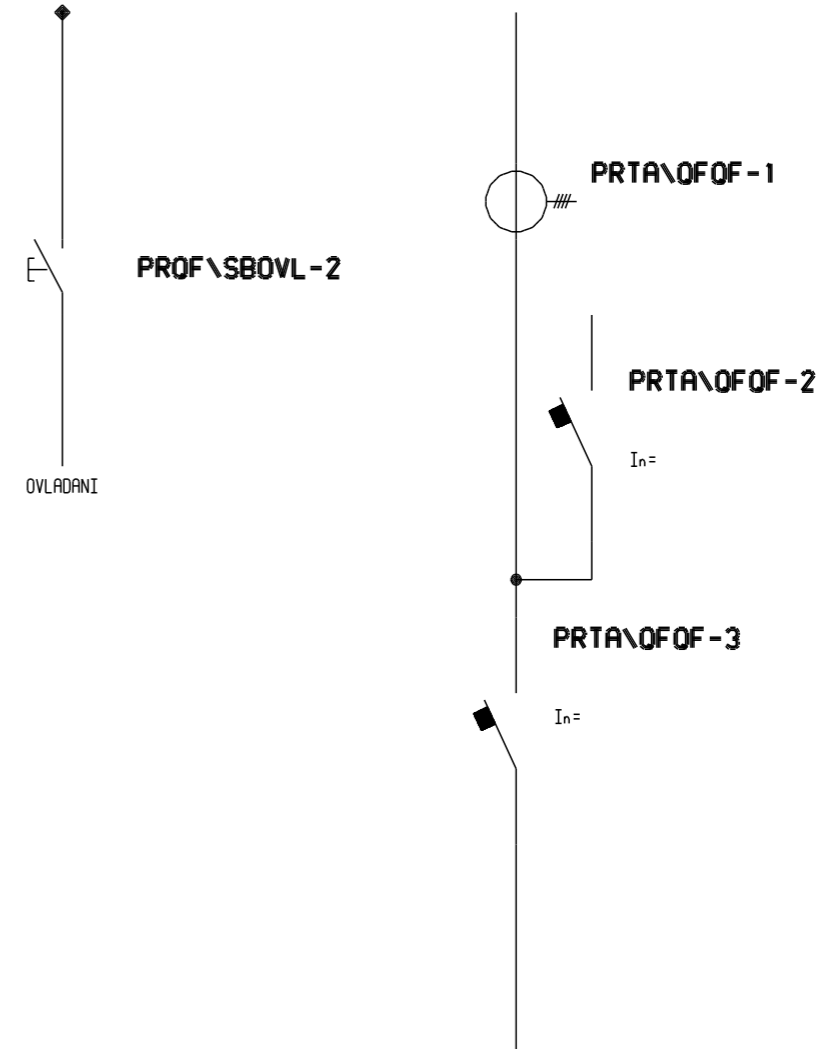

PRTA1<QF>\FUQF\FUOVL

PRTA1<QF>\FUQF\FUOVL

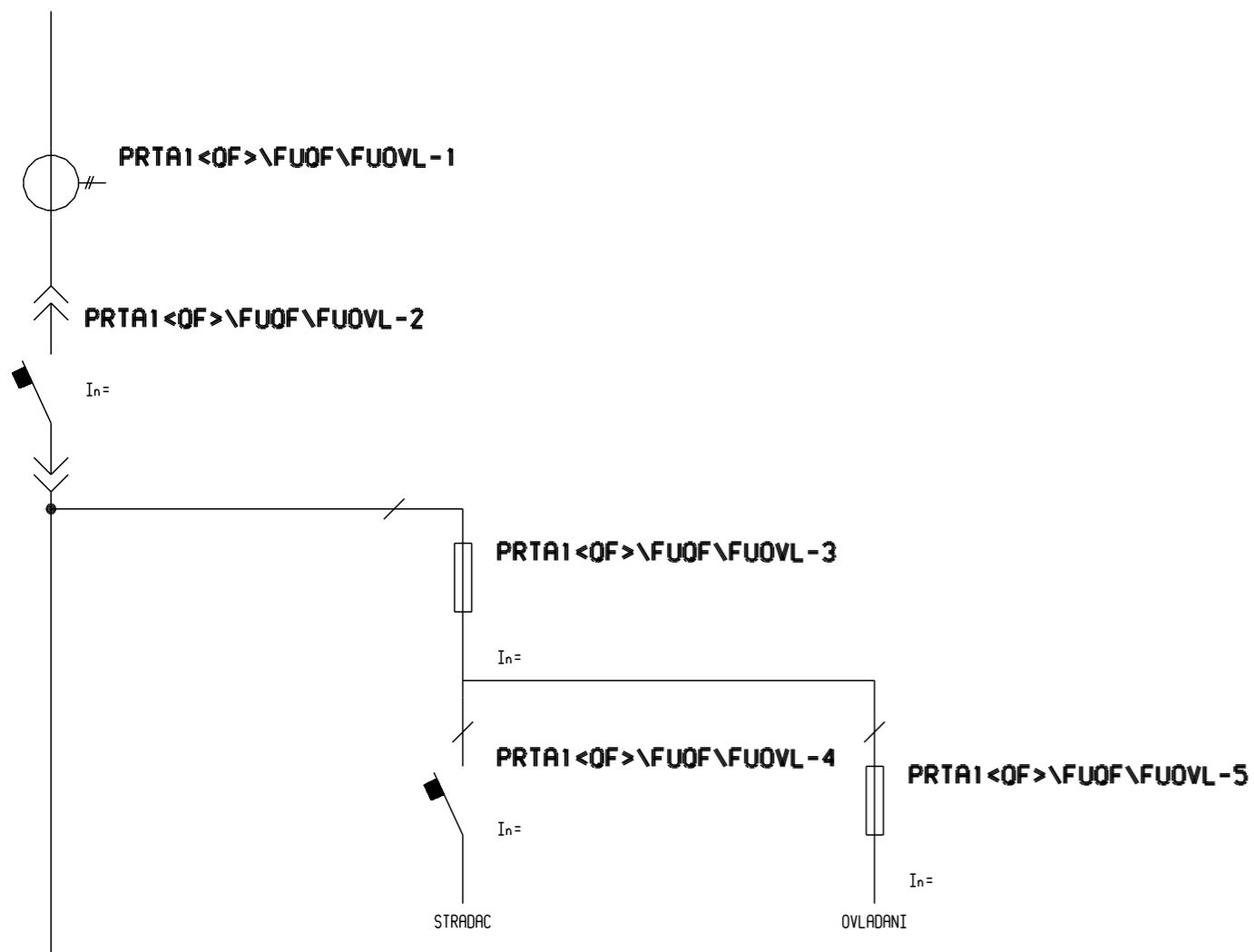

PRTA1<QF>\FUQF\FUOVL - 3 MODULY

\QF1

\QF1

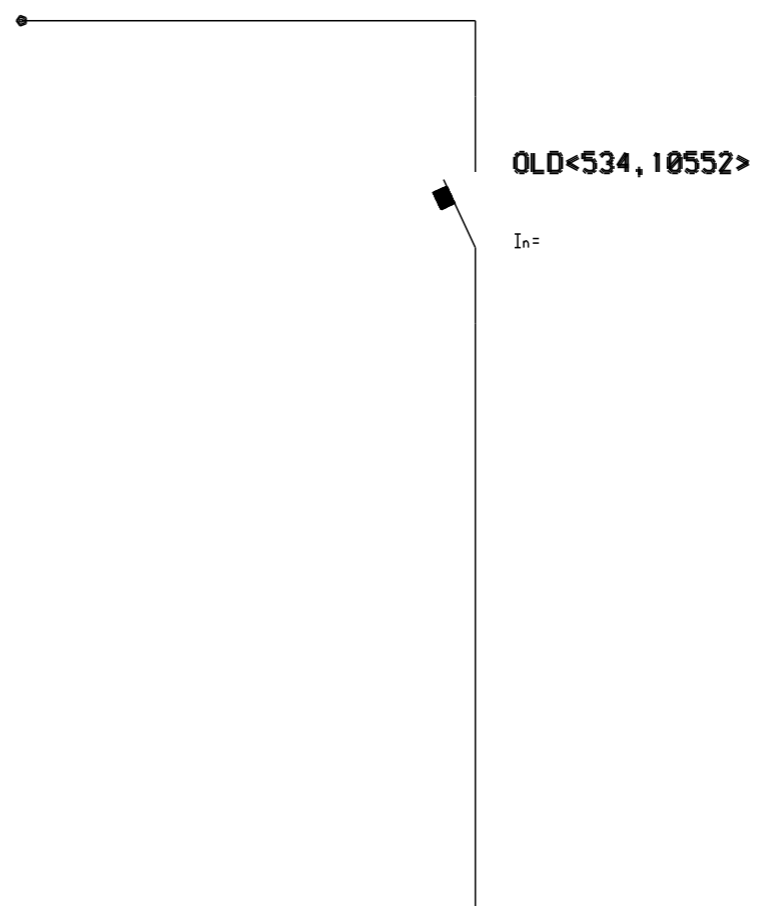

\QF1 - 1 MODUL

QFKMX1\OVL

QFKMX1\OVL

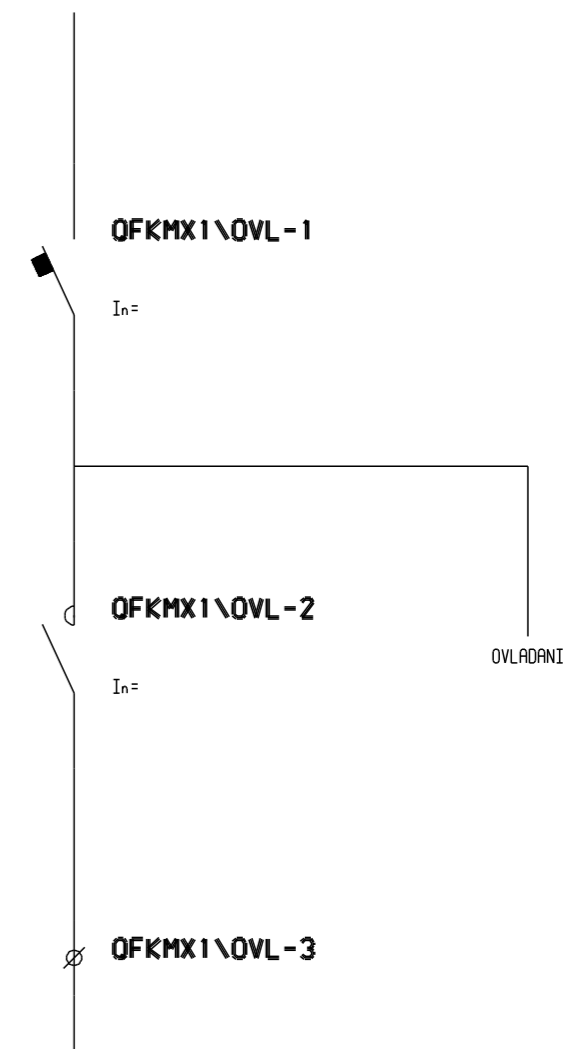

QFKMX1\OVL - 2 MODULY

QF3KMX3_1\QFOVL1

QF3KMX3_1\QFOVL1

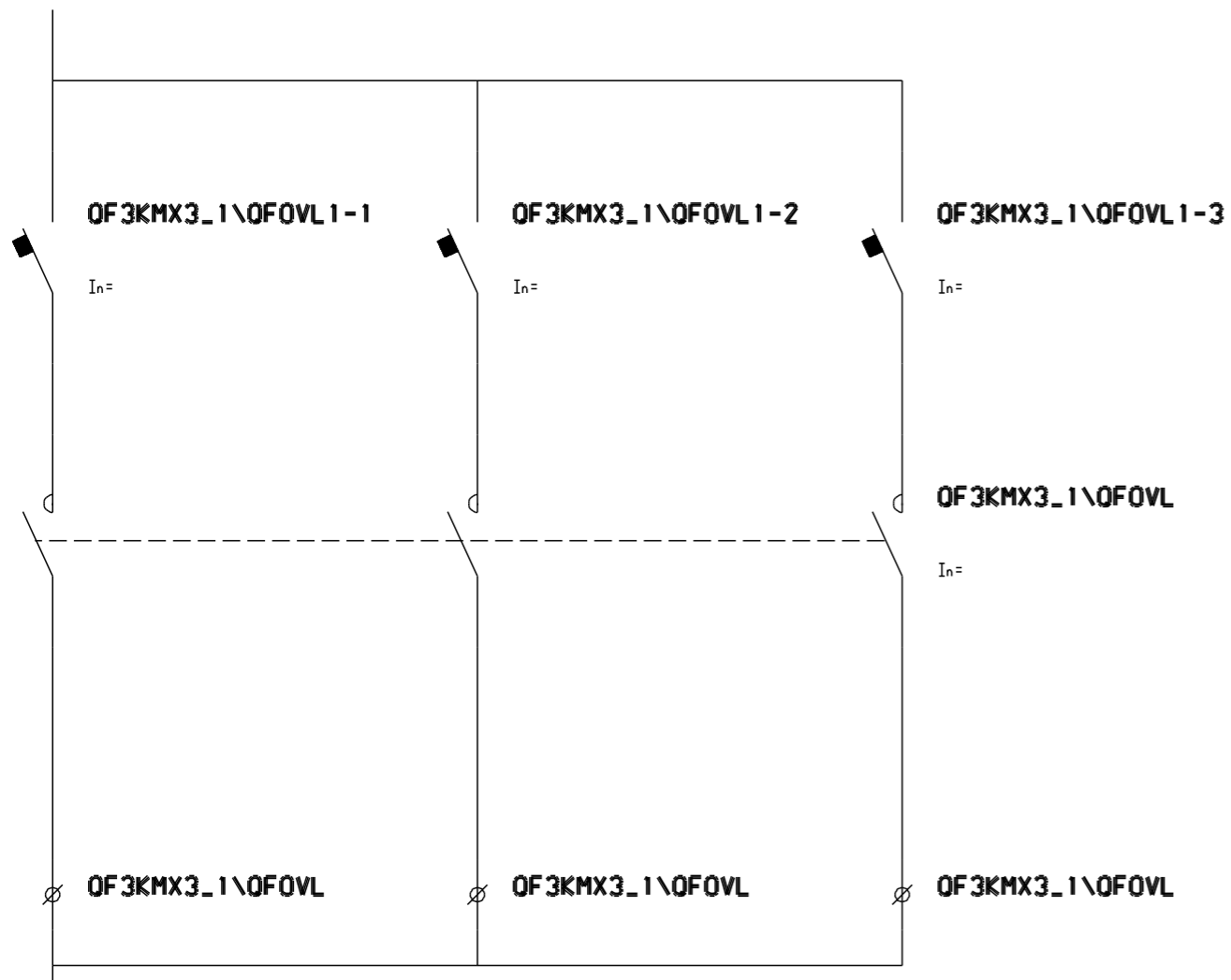

QF3KMX3_1\QFOVL1 - 4 MODULY

JISTIC OVLADANI NAPAJEN Z PRIPOJNICE WP

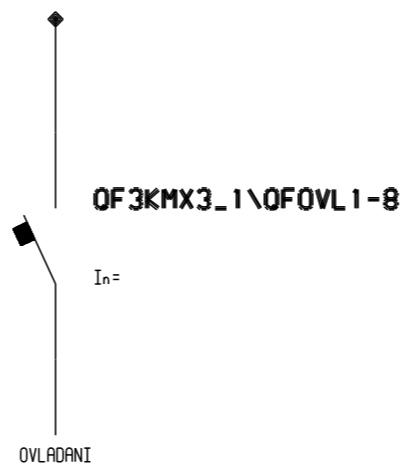

QFTX

QFTX

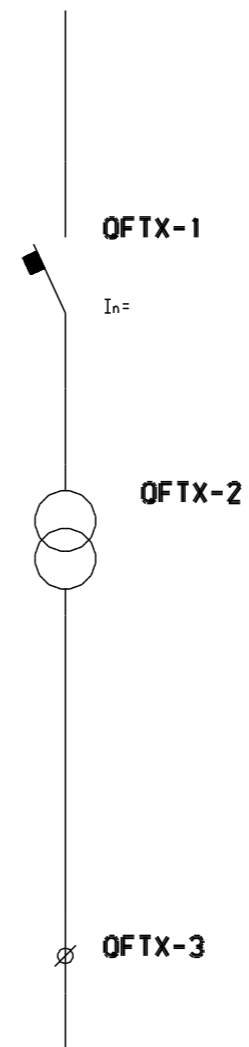

OFFVPEN

OFFVPEN

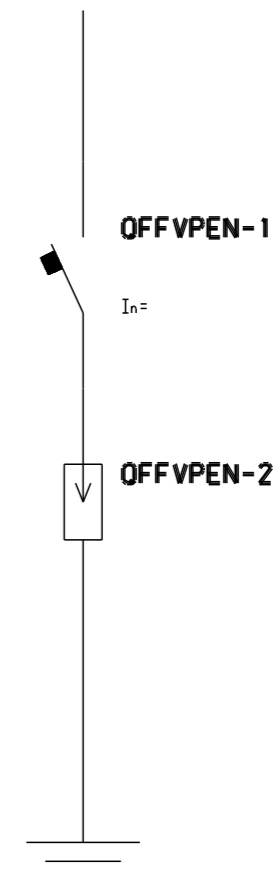

PRILOHA 2.1. TYPY ODBOCEK ODBOCKY ZACINAJICI JISTICEM-83

OFKMX\OFOVL3

PROFFUA\FU

PROFFUB\FU

PR<OF>\OFOVL

OFKMTA1

OFKMX\OFOVL3

PROFFUA\FU

PROFFUB\FU

PR<OF>\OFOVL

OFKMTA1

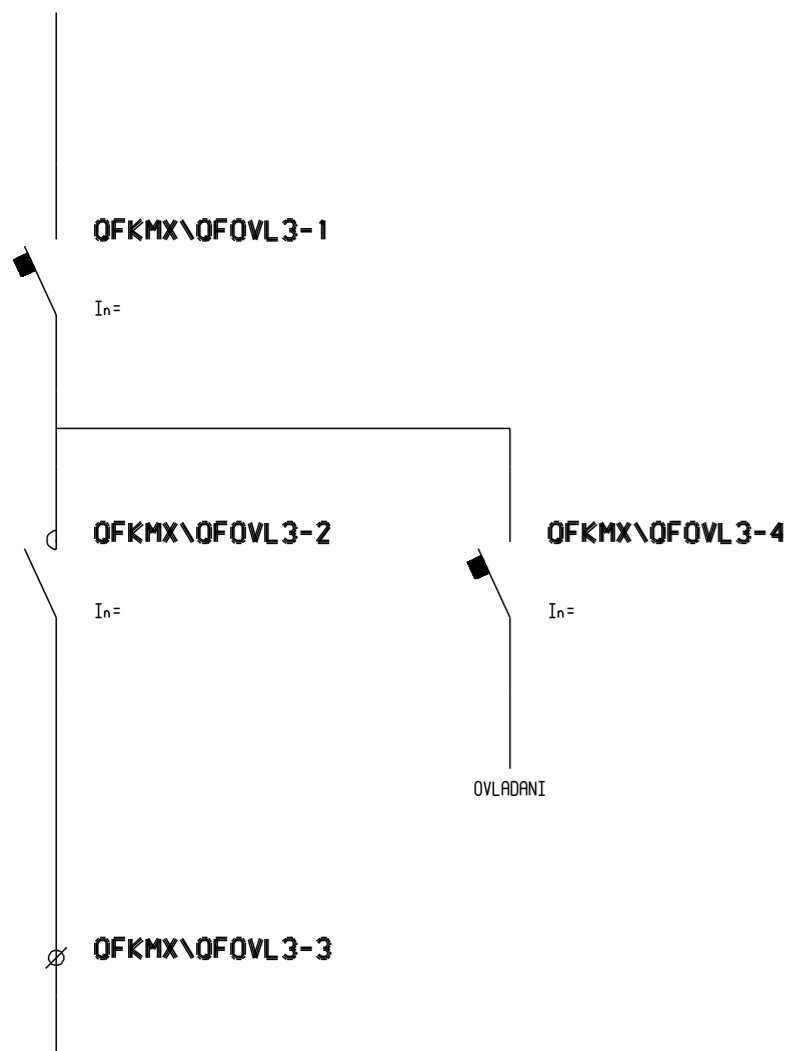

OFKMX\OFOVL3 - 2 MODULY

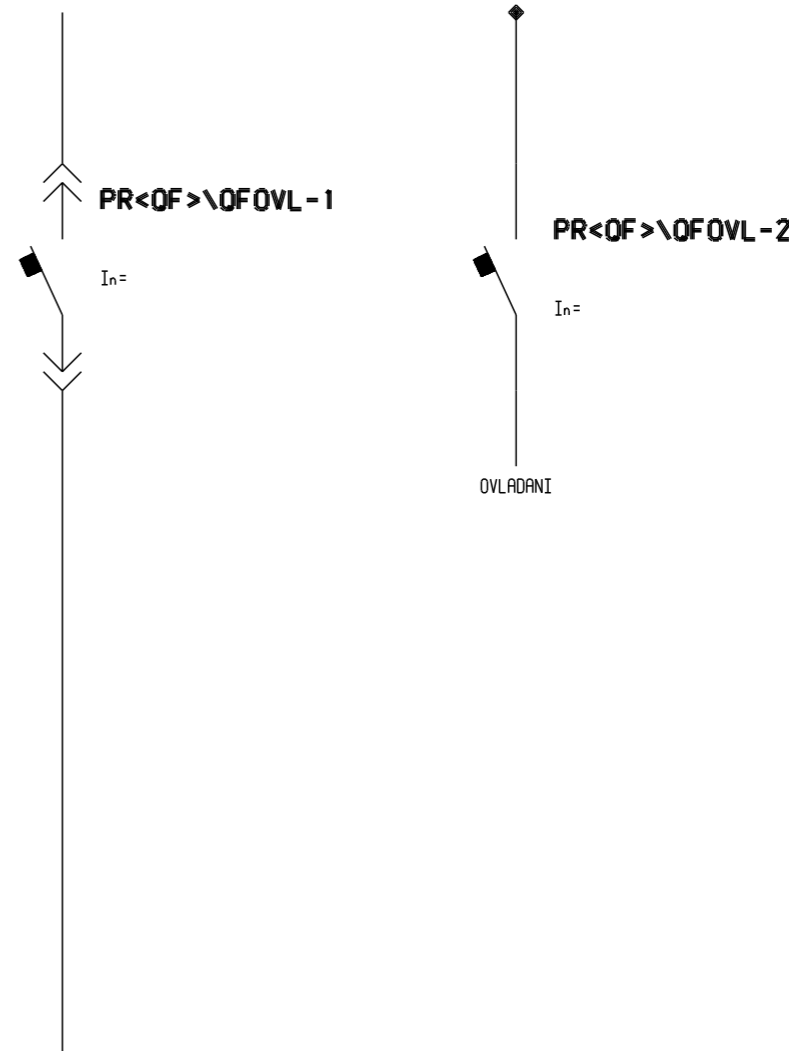
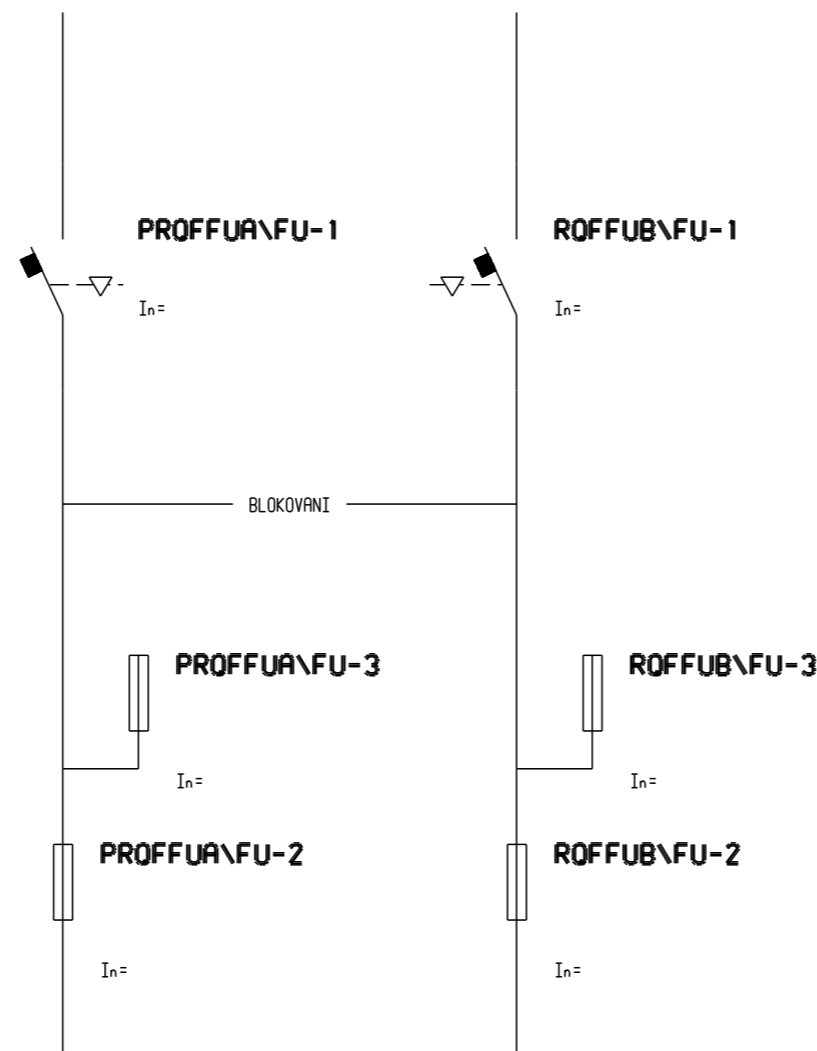

PR<OF>\OFOVL - 2 MODULY

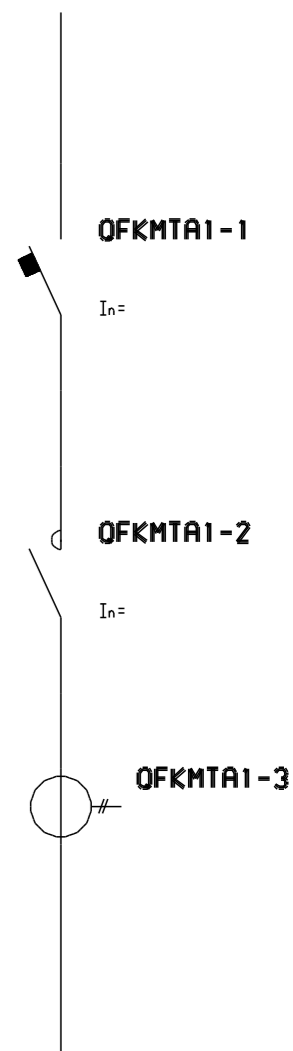

PROF\QFOFVL

OFFAKMX\QFOVL

OFTFU2X

OFREGX\X

PROF\QFOFVL

OFFAKMX\QFOVL

OFTFU2X

OFREGX\X

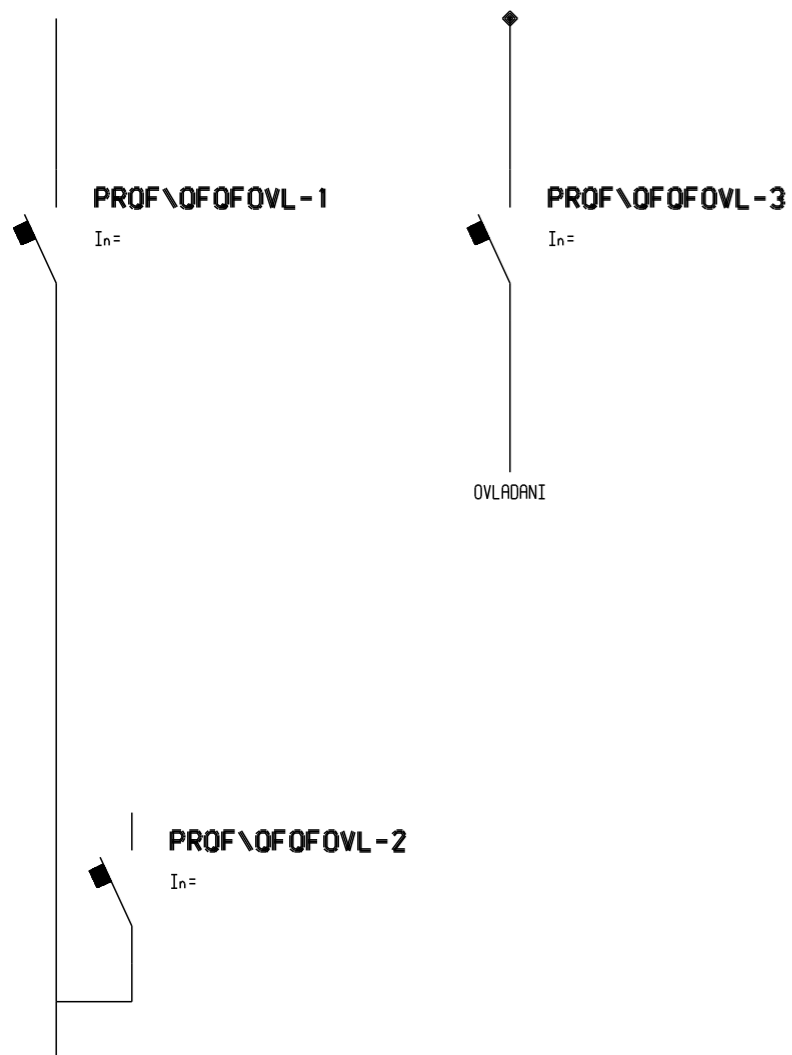

PROF\QFOFVL - 2 MODULY

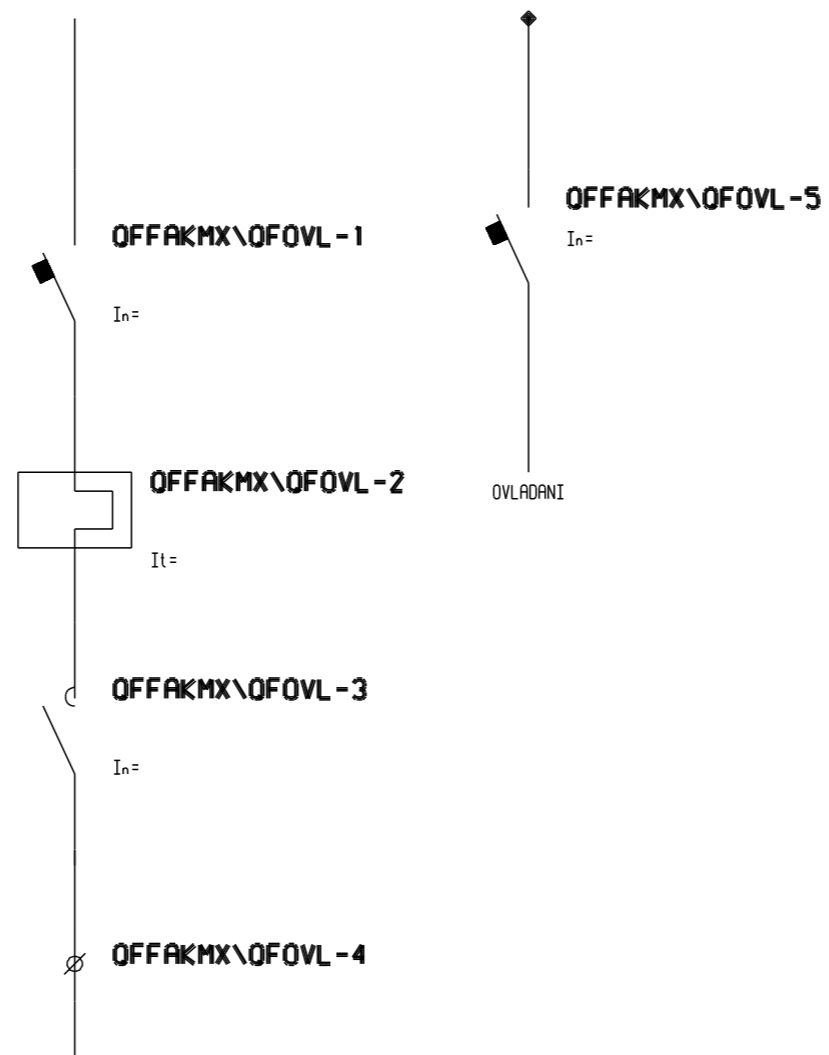

OFFAKMX\QFOVL - 2 MODULY

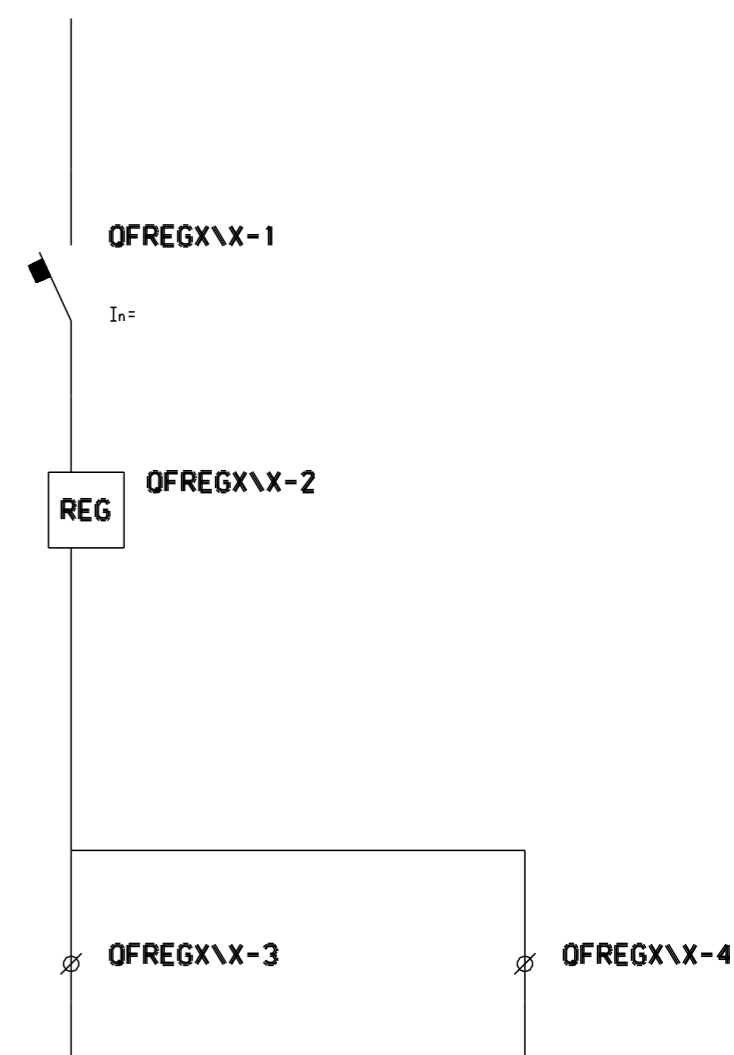
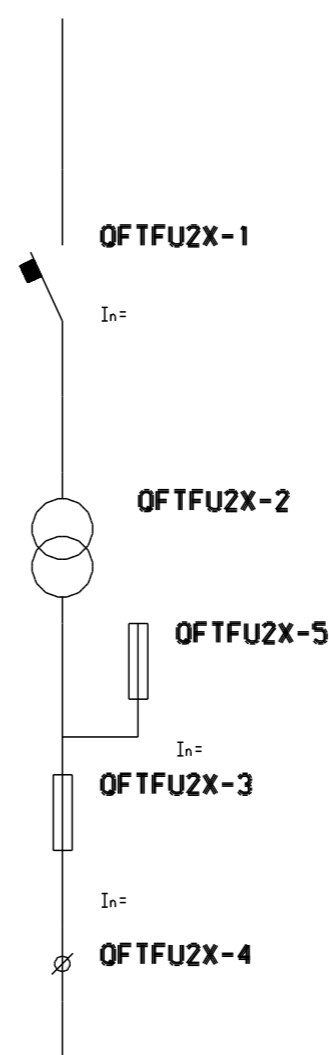

OFREGX\X - 2 MODULY

OFREGX

OFREGX

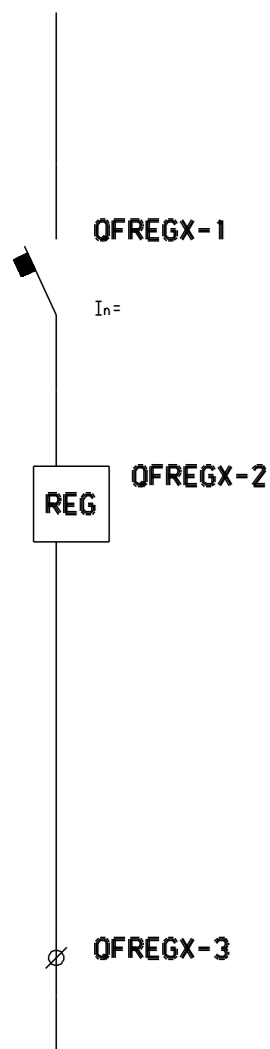

QTFUX\FUX

QTFUX\FUX

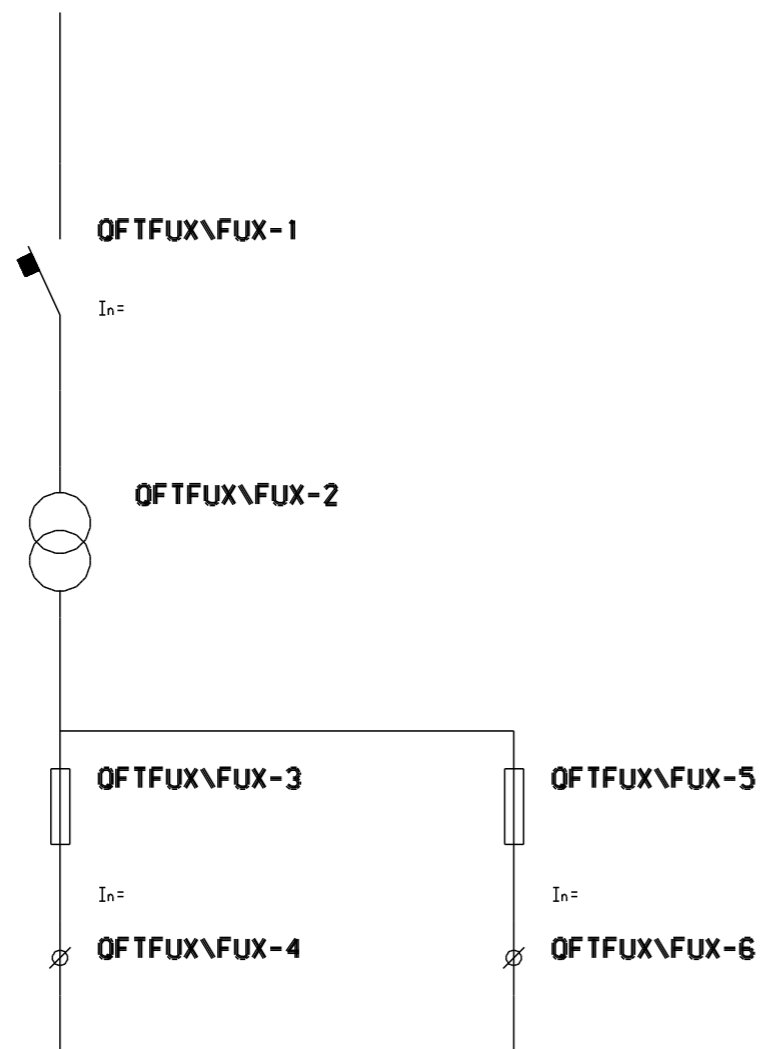

QTFUX\FUX - 2 MODULY

OFFUKM3KMX

OFFUKM3KMX

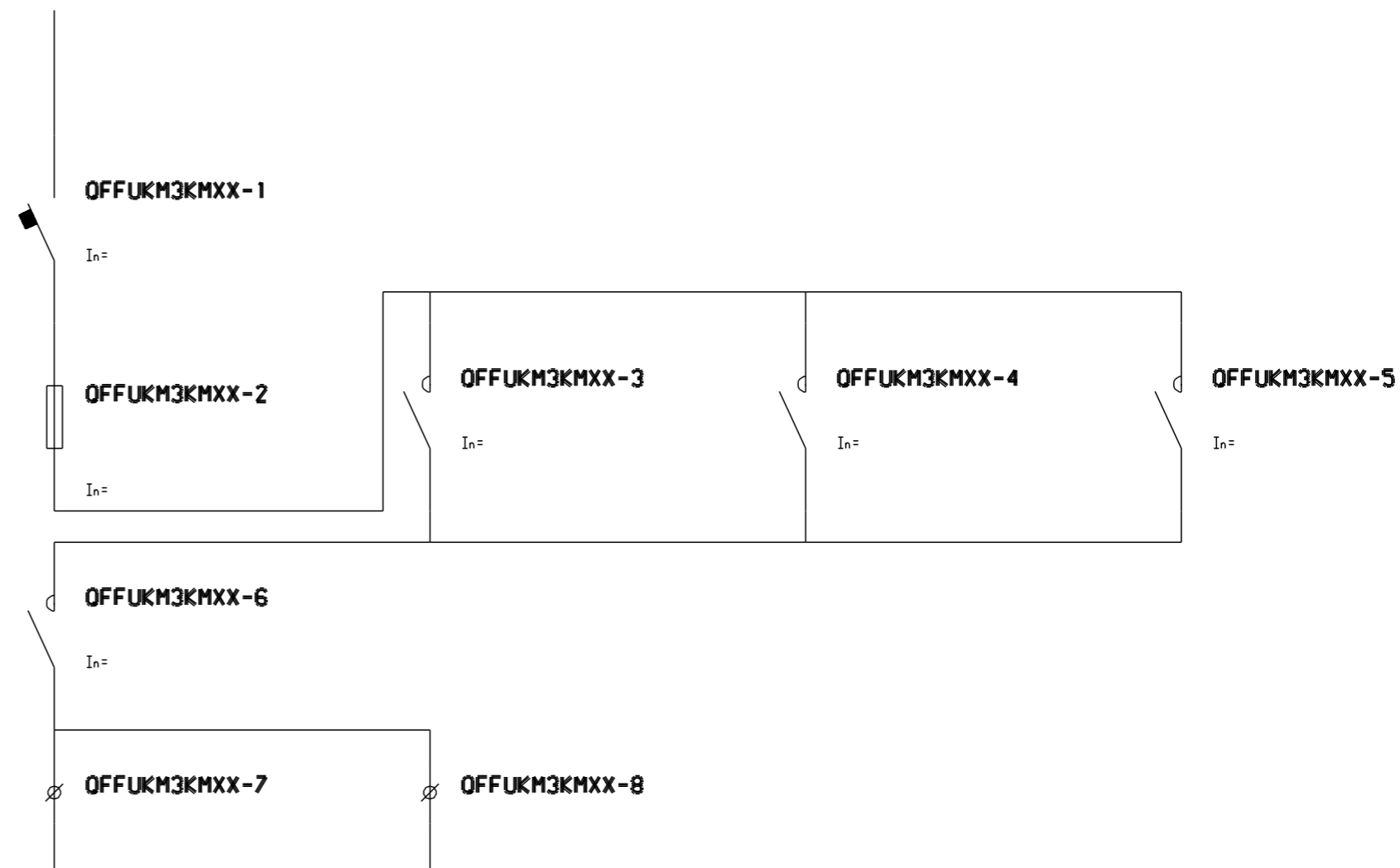

OFFUKM3KMX - 4 MODULY

QFKM2X\X

QFKM2X\X

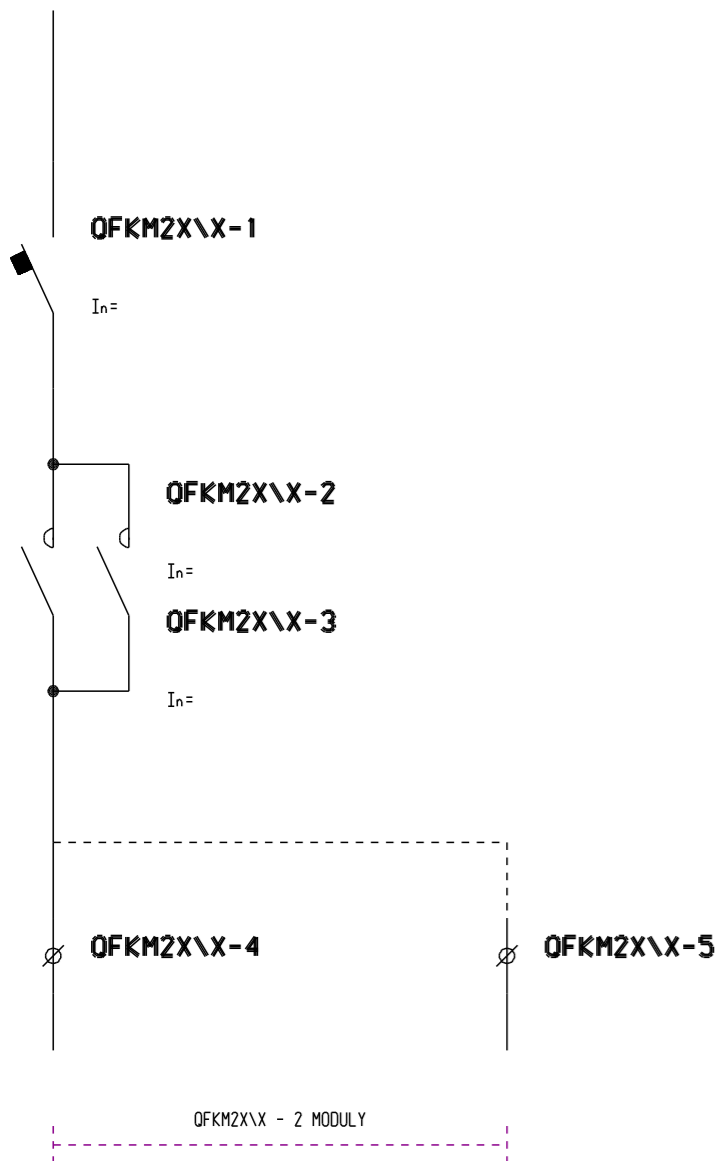

QFOFKM2X

QFOFKM2X

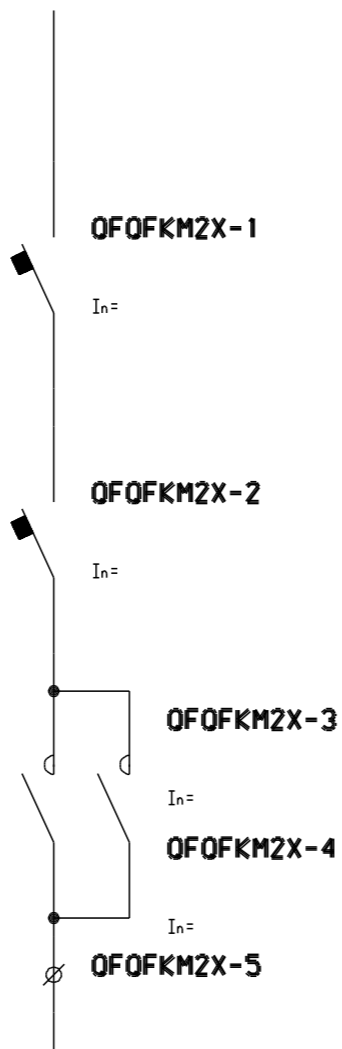

QF3KM2

QF3KM2

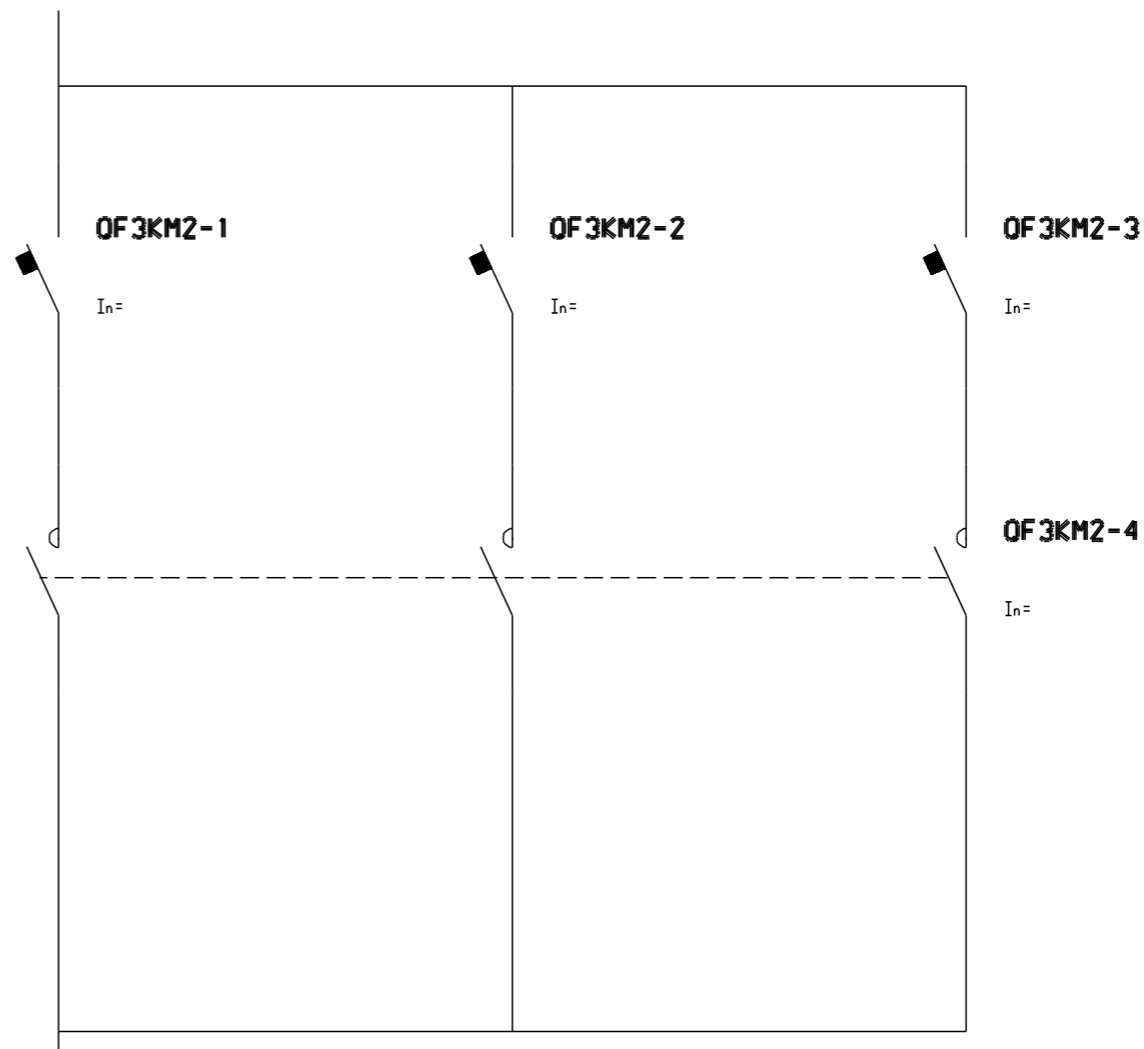

PRTA1<OF>\QF3WP

PR<OF>\QF2

OFLED

OFTOPR2

PRTA1<OF>\QF3WP

PR<OF>\QF2

OFLED

OFTOPR2

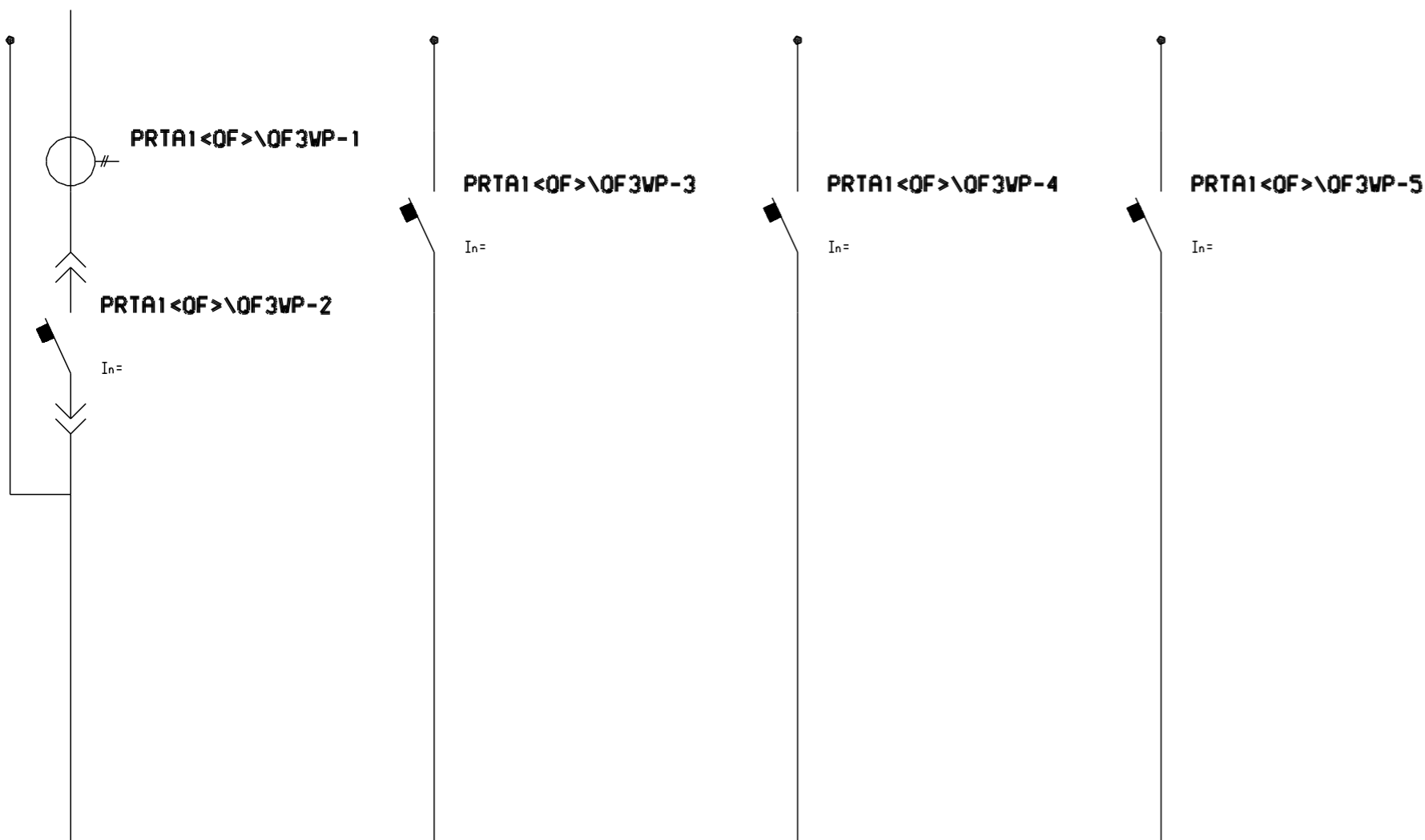

PRTA1<OF>\QF3WP - 4 MODULY

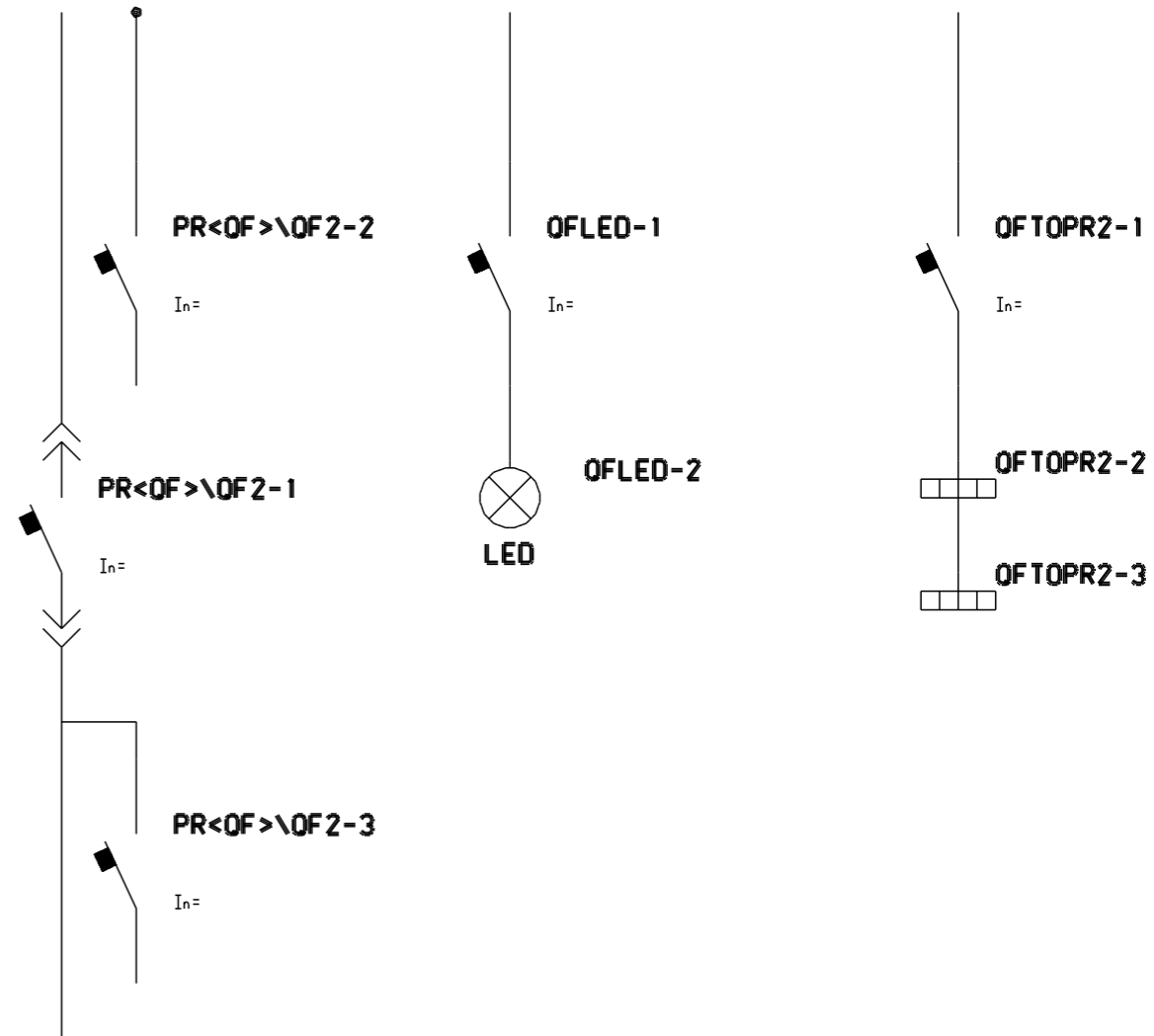

OFFVPEN\OFTE

OFOFIX

OFVKX\X\X\X

OFTFUX

OFFVPEN\OFTE

OFOFIX

OFVKX\X\X\X

OFTFUX

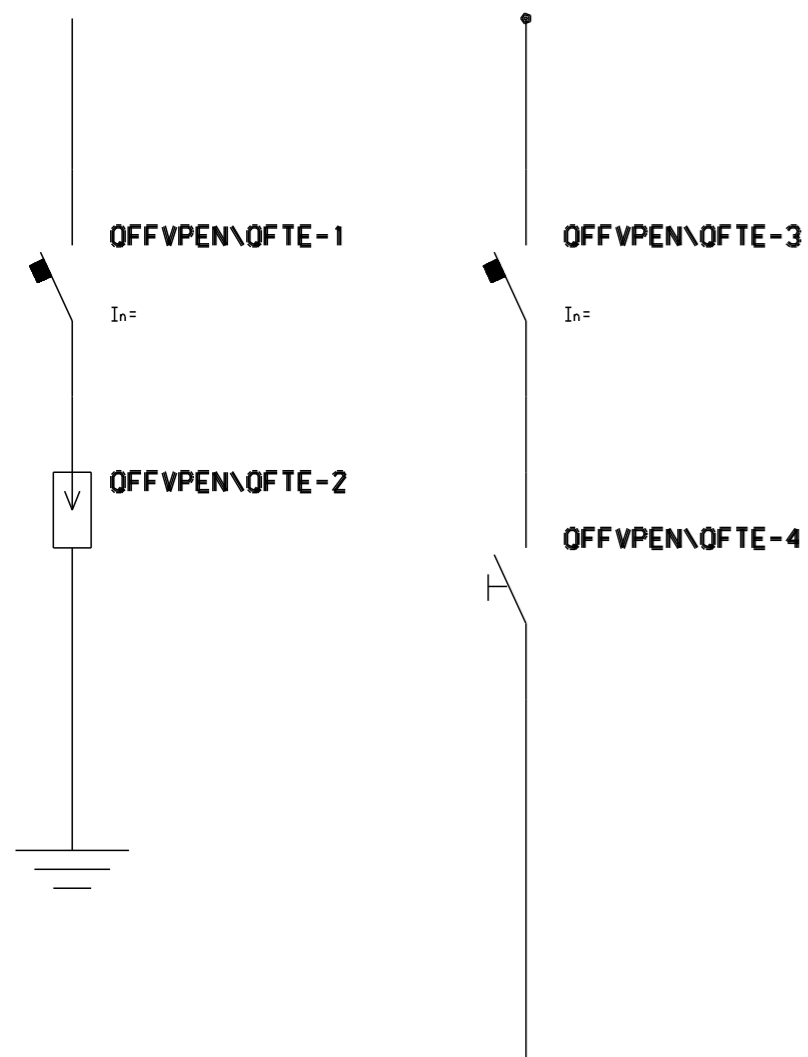

OFFVPEN\OFTE - 2 MODULY

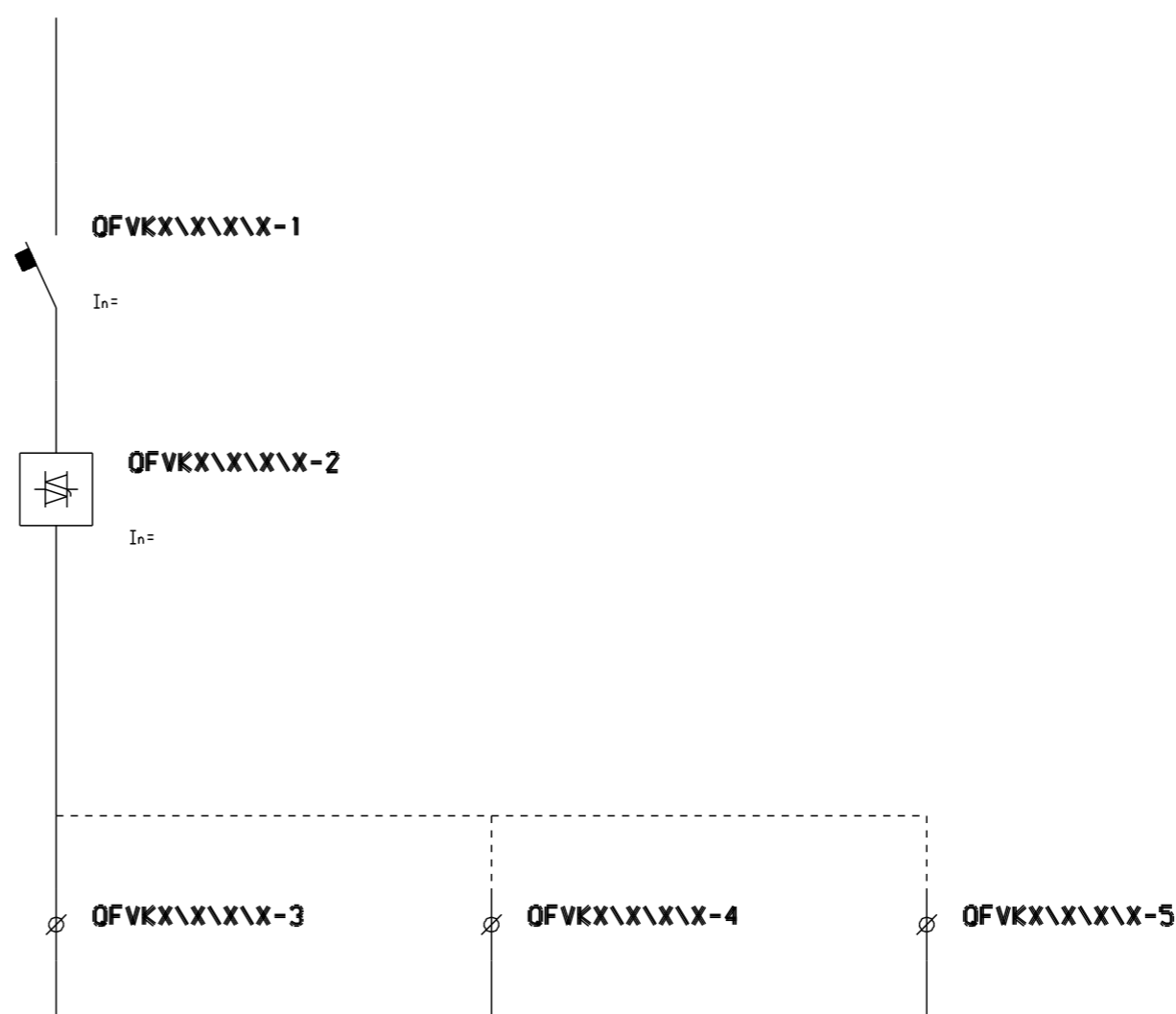
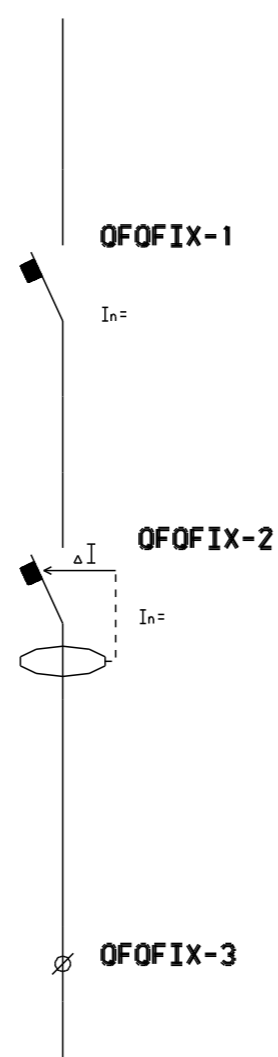

OFVKX\X\X\X - 3 MODULY

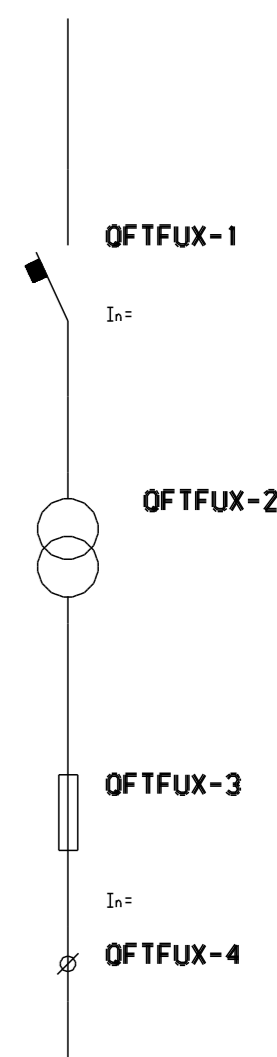

PROFIOMX\FV\TLF

PROFIOMX\FV\TLFV\W2

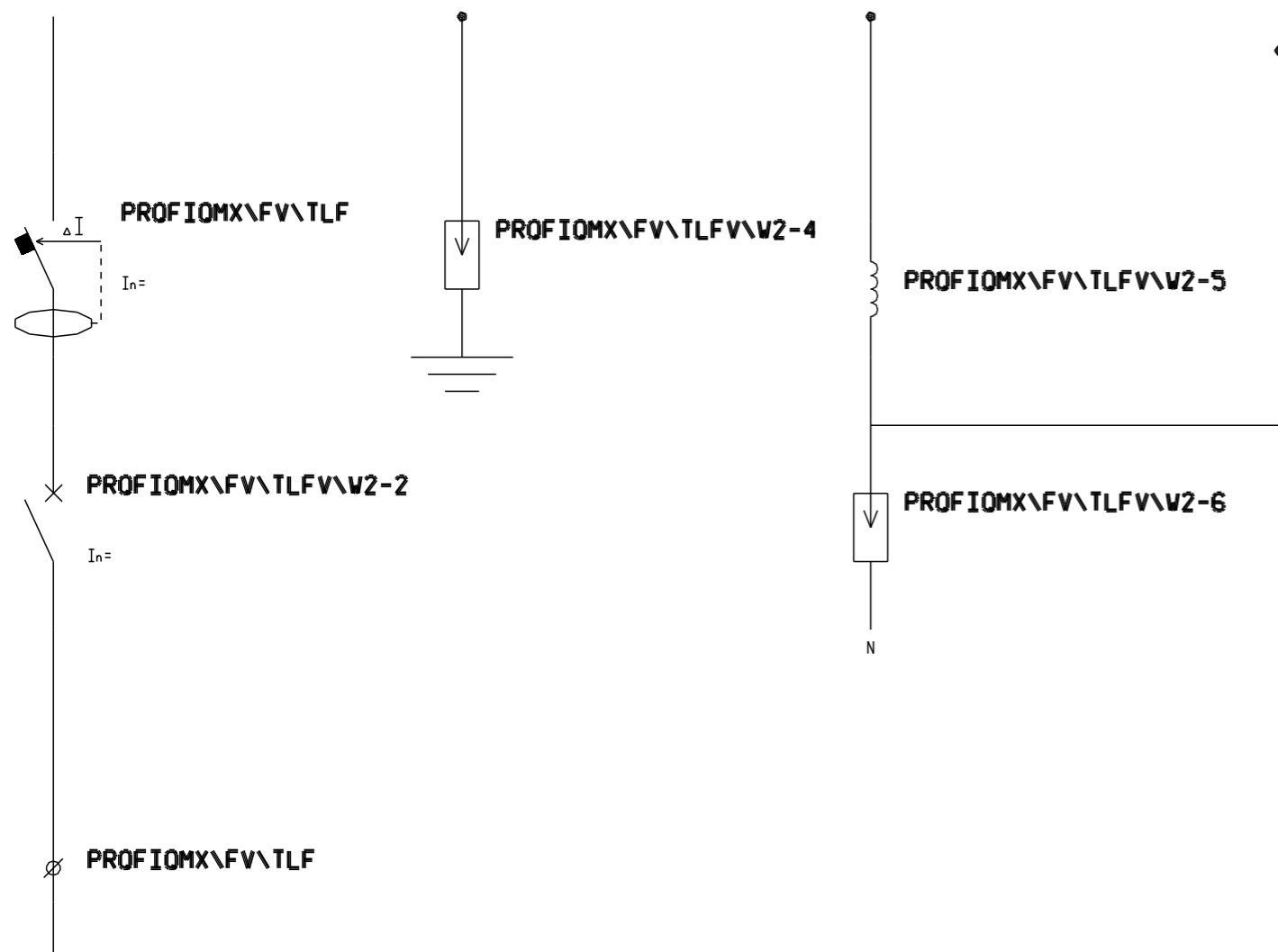

PROFIOMX\FV\TLFV\W2 - 4 MODULY

OFZVGUX

OFZVGUX

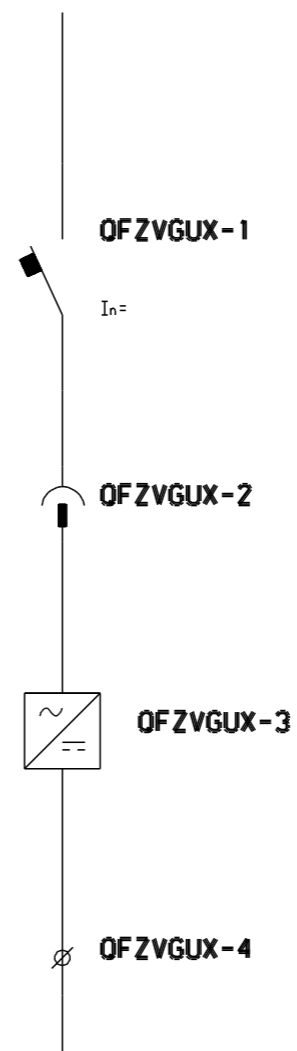

PR<OF>X

PR<OF>X

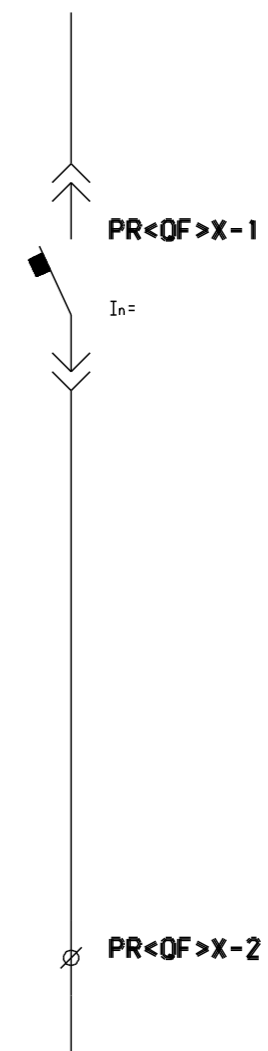

PR<OF>ZXX

PR<OF>ZXX

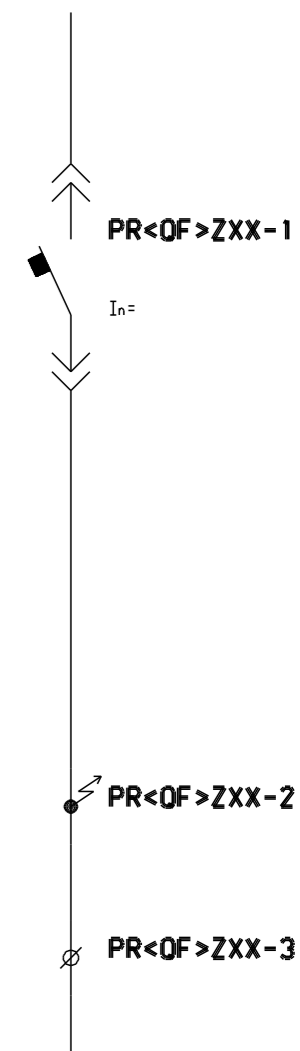

QFSAX

QFSAX

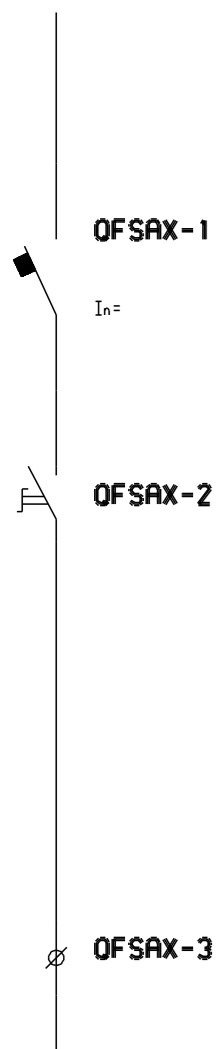

QFKMX\SAX

QFKMX\SAX

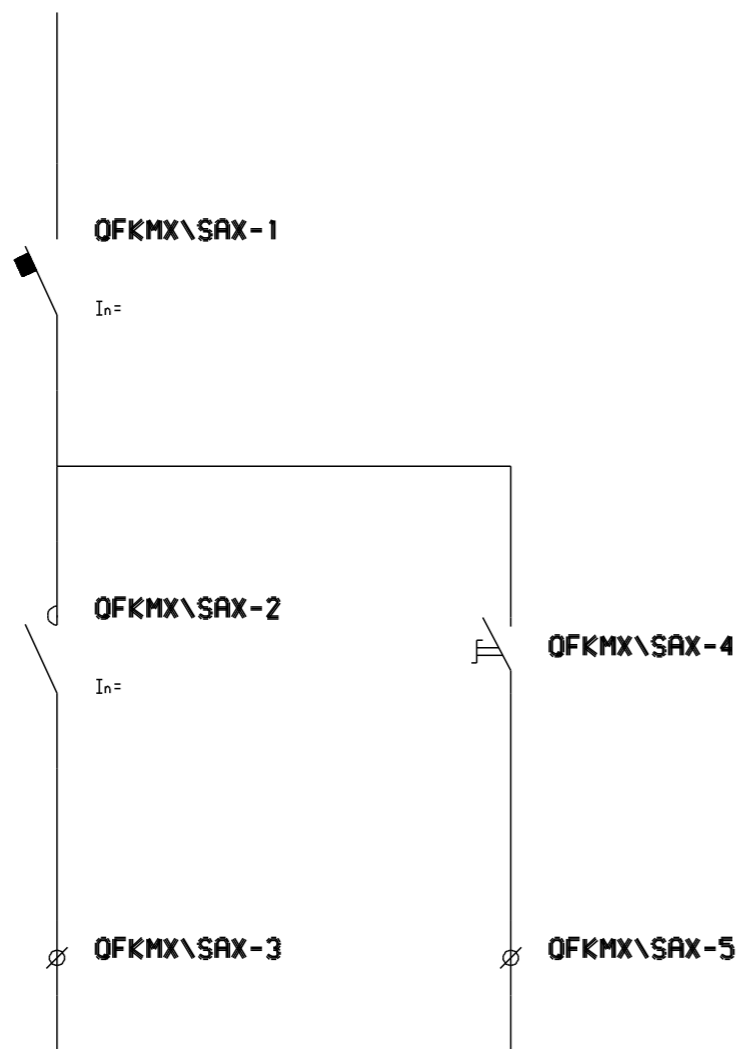

QFKMX\SAX - 2 MODULY

QFOVL\FV\QMABWP

QFOVL\FV\QMABWP

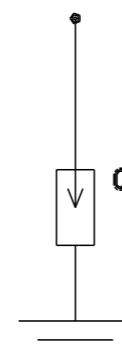
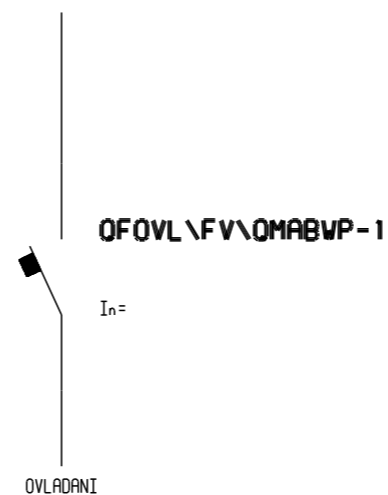

QFOVL\FV\QMABWP



QFOVL\FV\QMABWP-

$I_n =$

QFOVL\FV\QMABWP - 4 MODULY

OFFVPEN\OFTEM

OFFAKM2X

PRTA<QF>\FU\QF

QFX\QFOVL

OFFVPEN\OFTEM

OFFAKM2X

PRTA<QF>\FU\QF

QFX\QFOVL

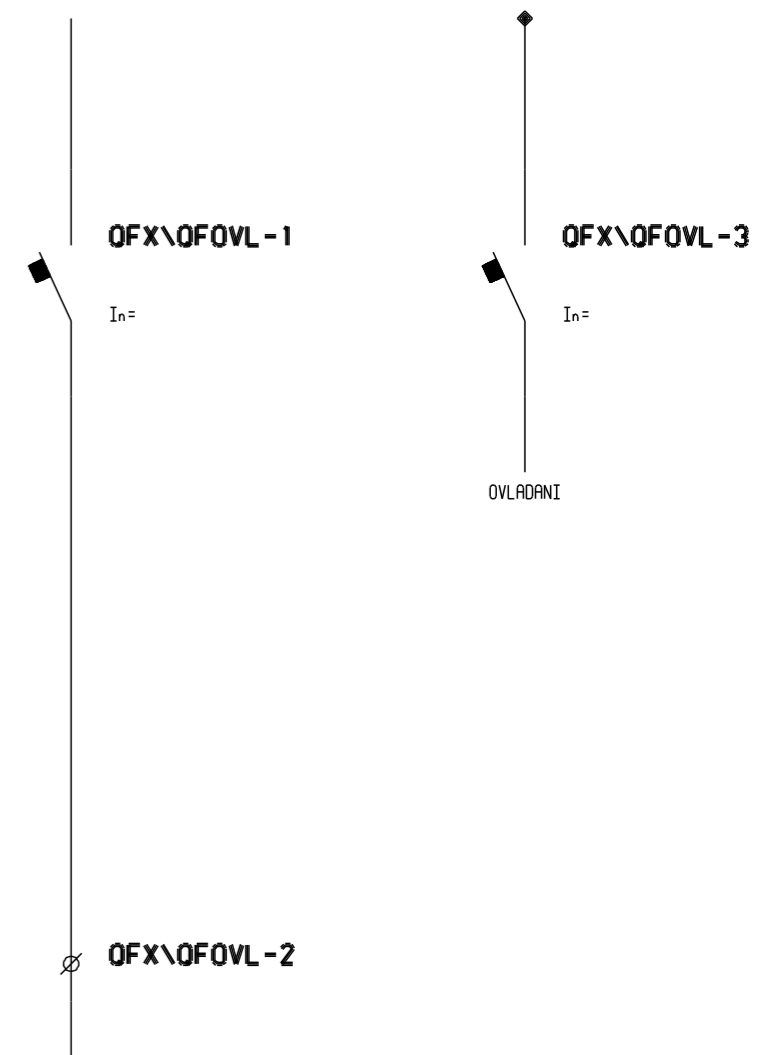
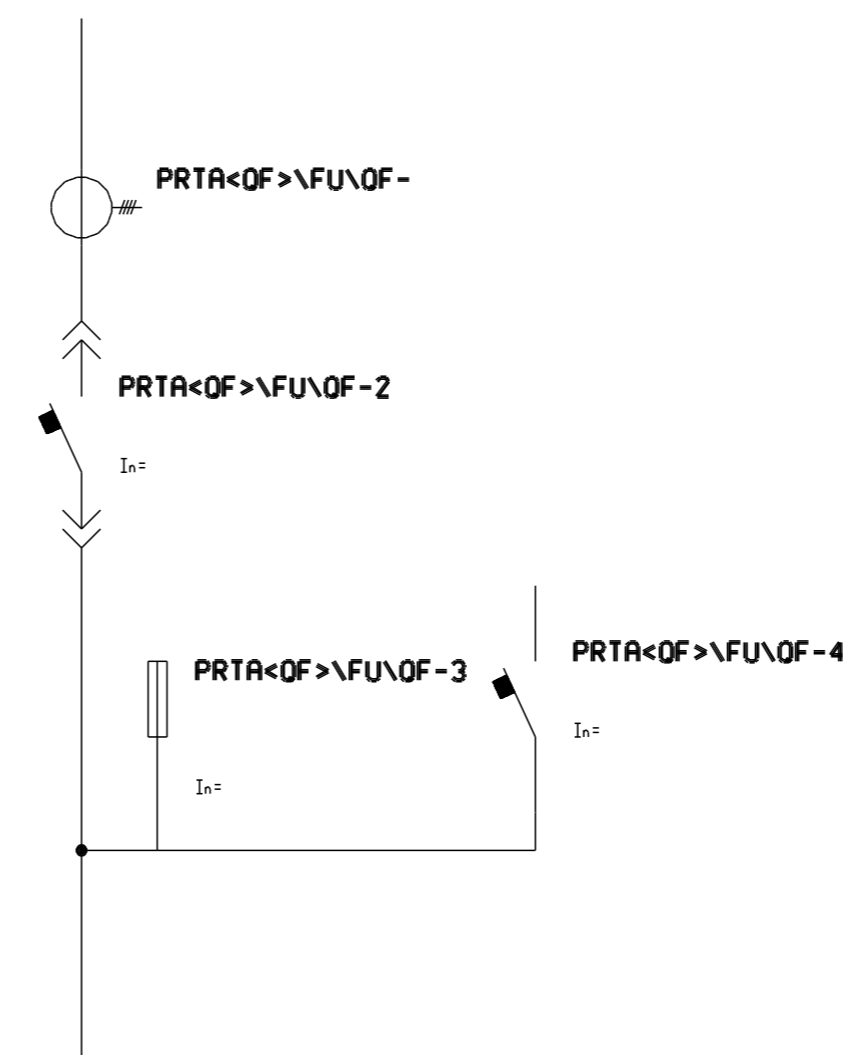
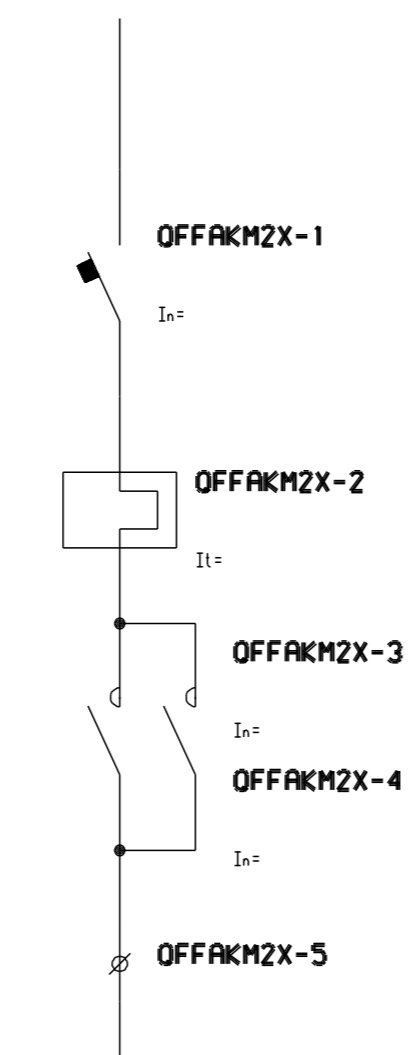
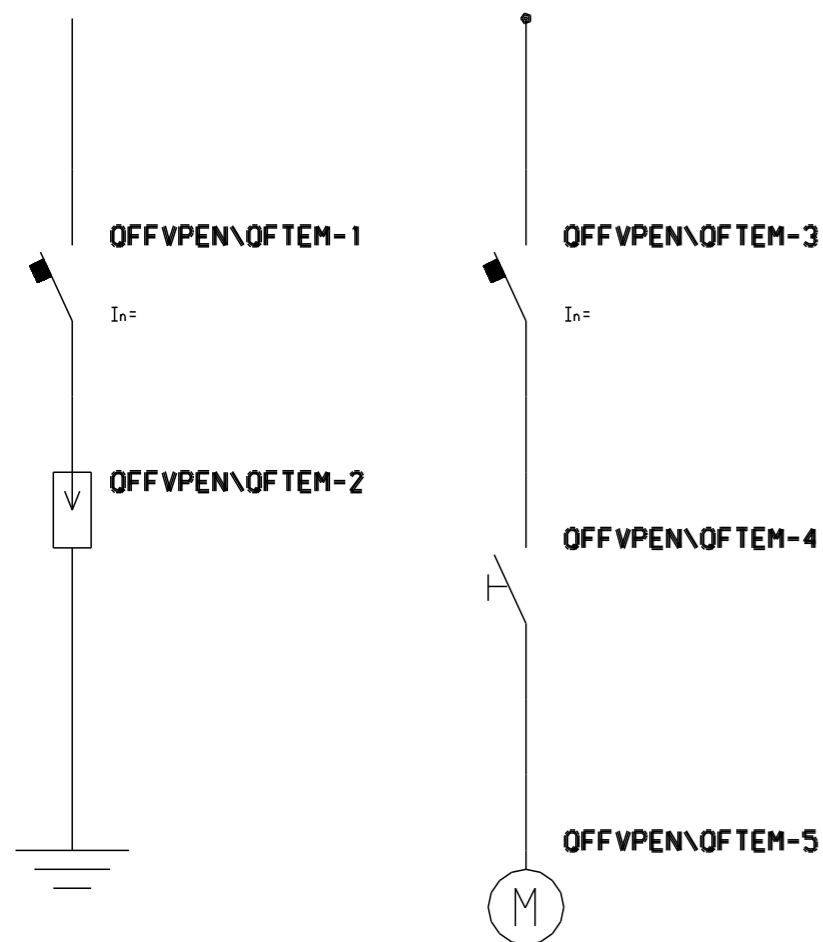

OFFVPEN\OFTEM - 2 MODULY

PRTA<QF>\FU\QF - 2 MODULY

QFX\QFOVL - 2 MODULY

QFKM2\QFOVL

QFKM2\QFOVL

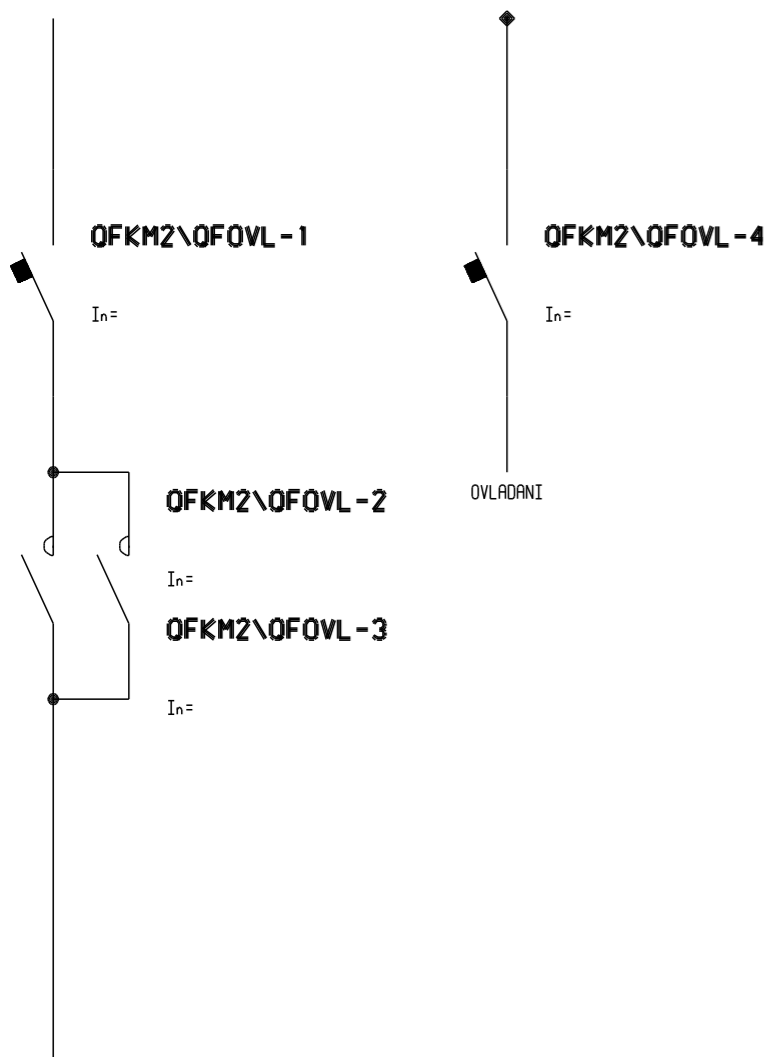

QFKM2\QFOVL - 2 MODULY

QFKM\QFOFOVL

QFKM\QFOFOVL

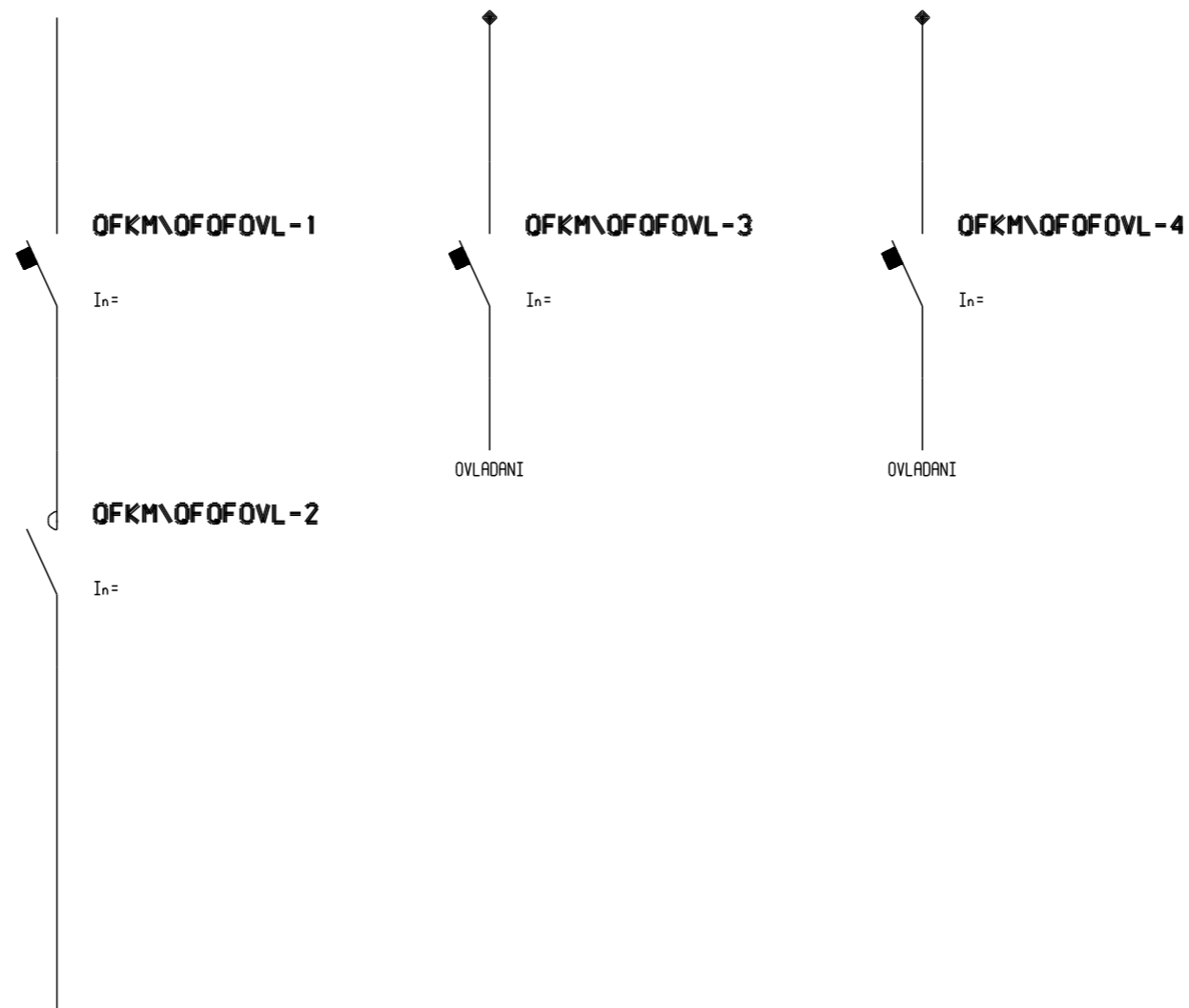

QFKM\QFOFOVL - 3 MODULY