

FU

**FU**

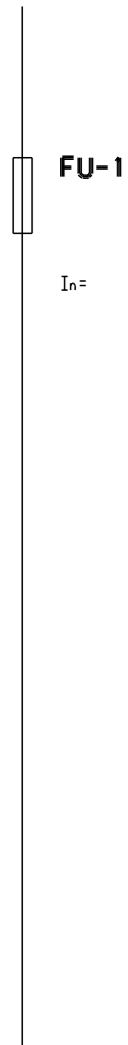

FUS

**FUS**

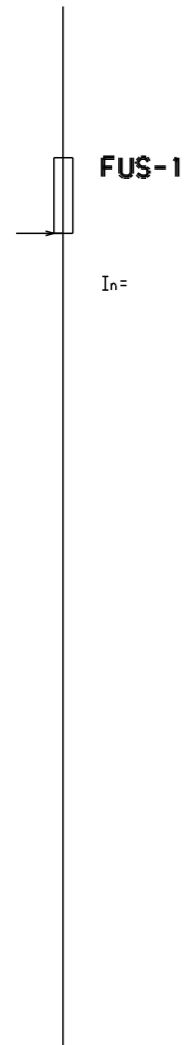

FUOM

**FUOM**

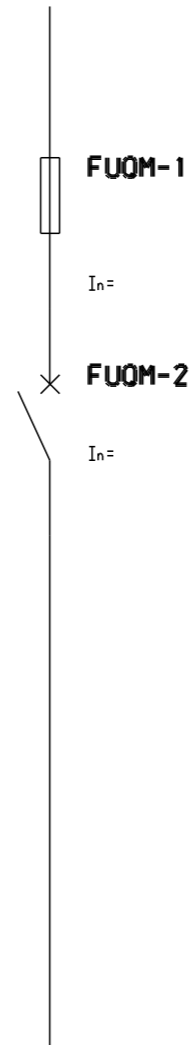

FUSOM

**FUSOM**

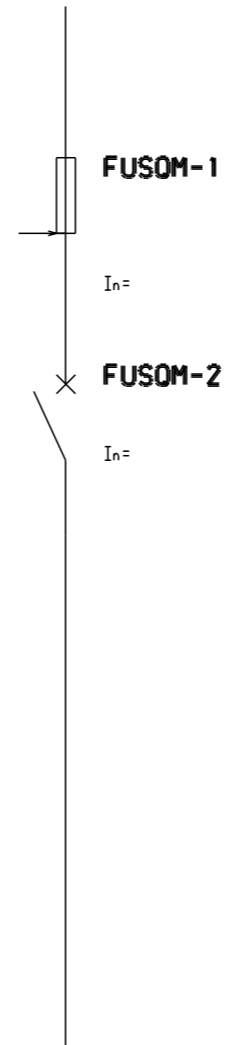

FUSOMTA1

**FUSOMTA1**

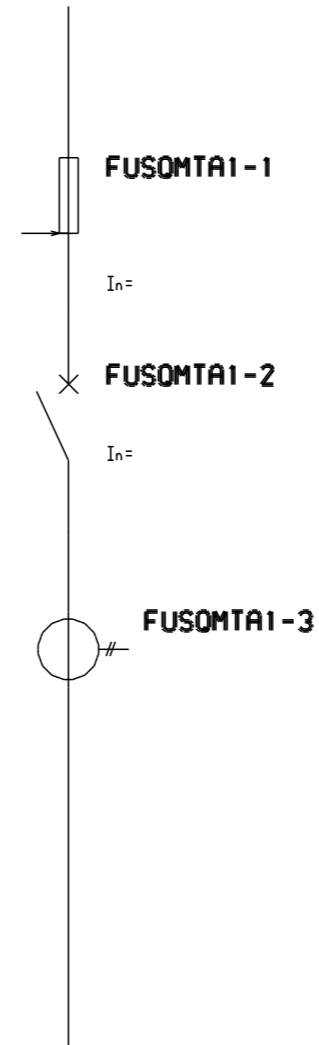

FUKM

**FUKM**

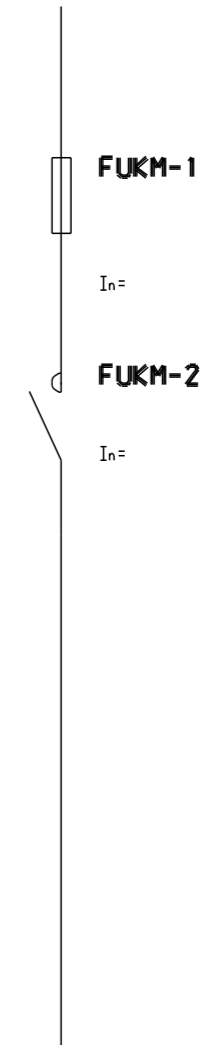

FUSKM

**FUSKM**

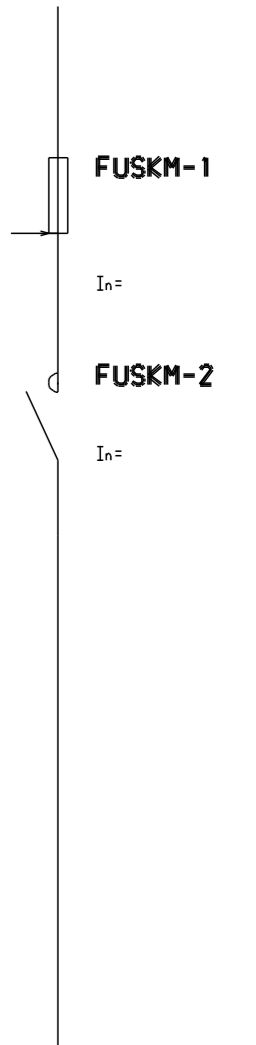

FUOF

**FUOF**

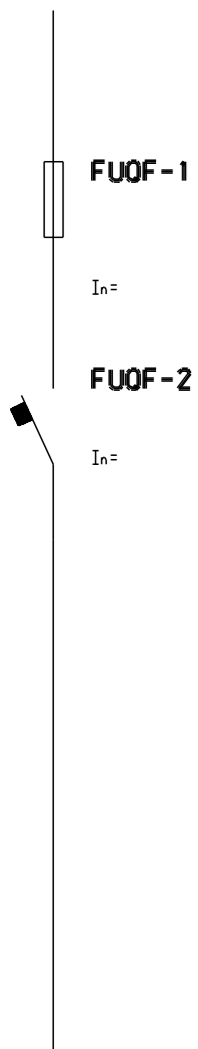

FUSOF

**FUSOF**

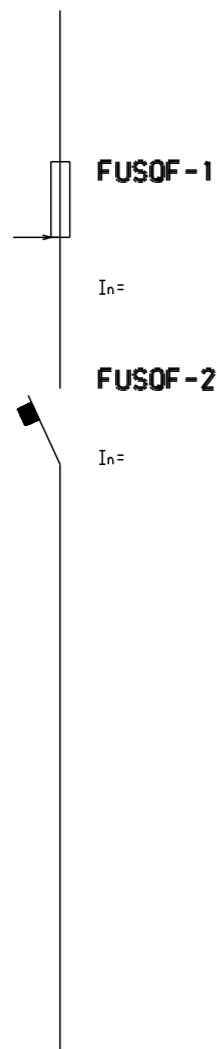

FUQFKM

**FUQFKM**

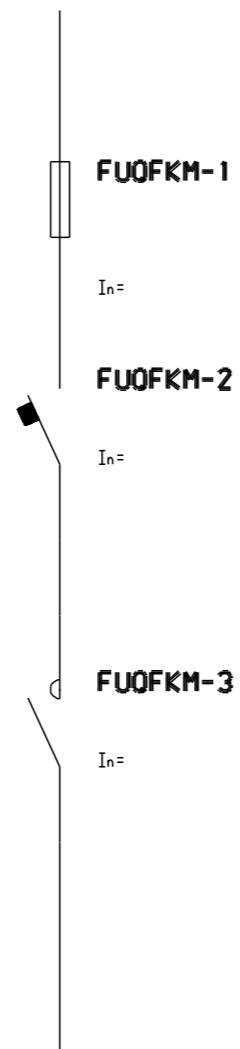

FUSQFKM

**FUSQFKM**

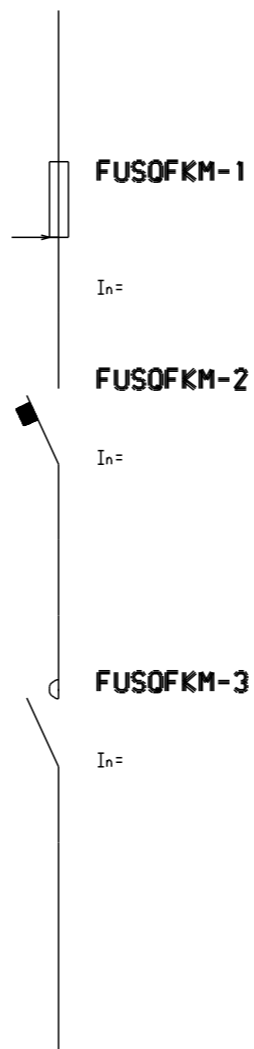

FUKMOF

**FUKMOF**

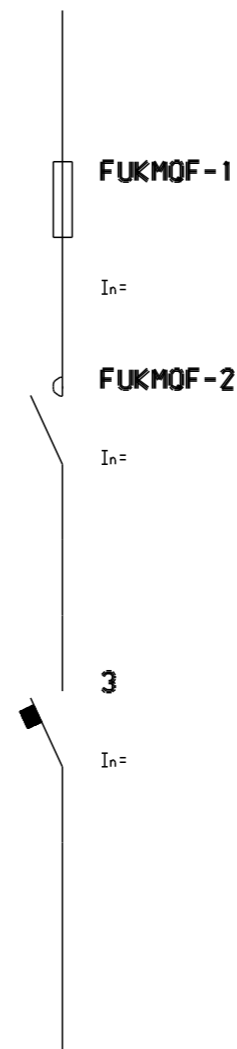

FUKMFA

**FUKMFA**

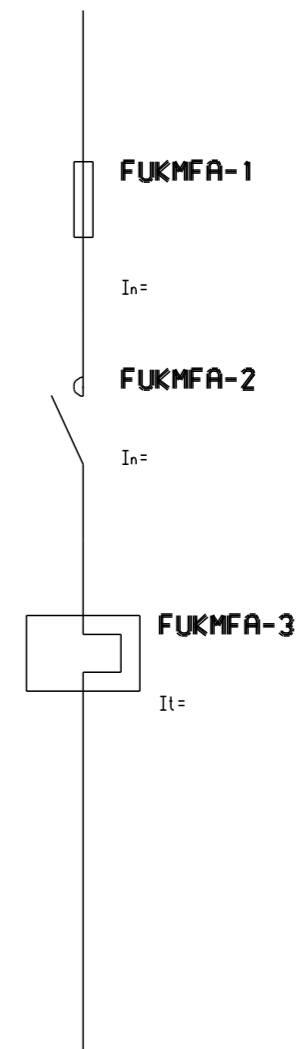

FUSKMFA

**FUSKMFA**

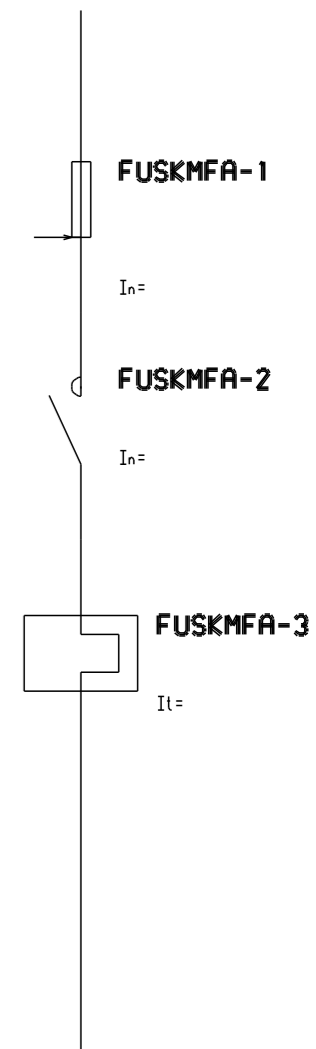

FUKMTA

FUSKMTA

FUQFKMFA

FUQMKMFA

FUQMKMFAN

FUKM2

FUSQFKM2

### FUKMTA

### FUSKMTA

### FUQFKMFA

### FUQMKMFA

### FUQMKMFAN

### FUKM2

### FUSQFKM2

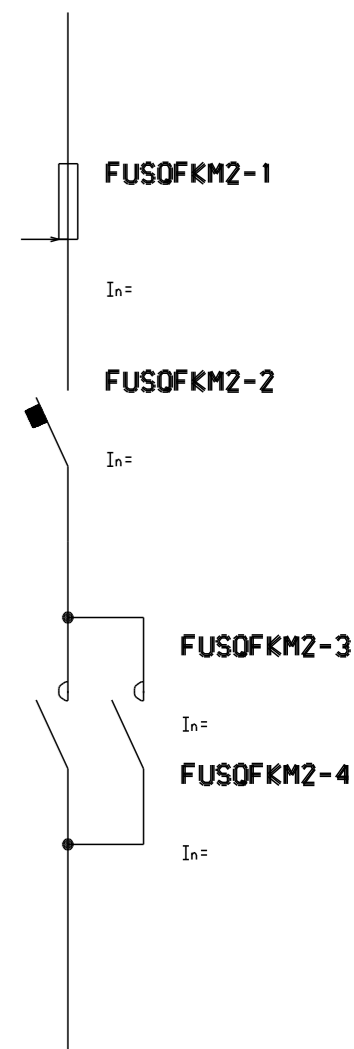
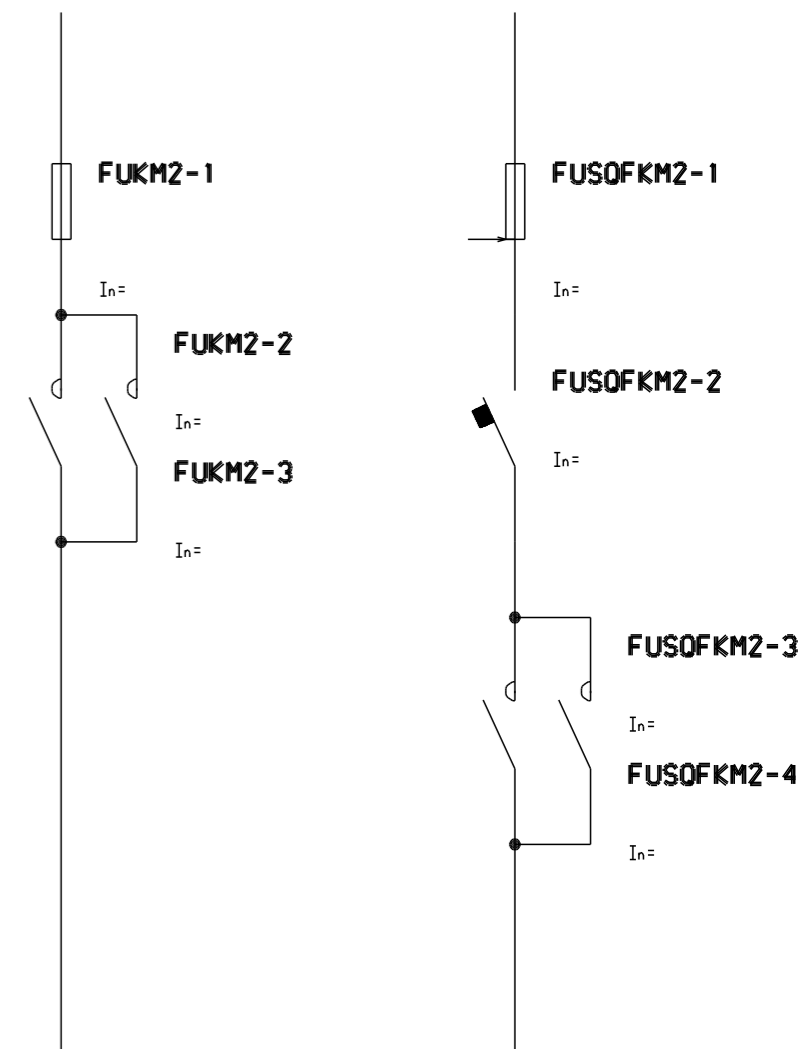
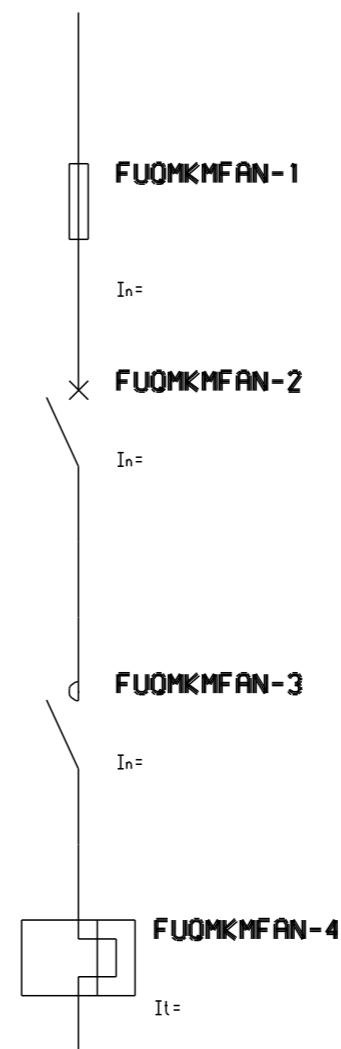
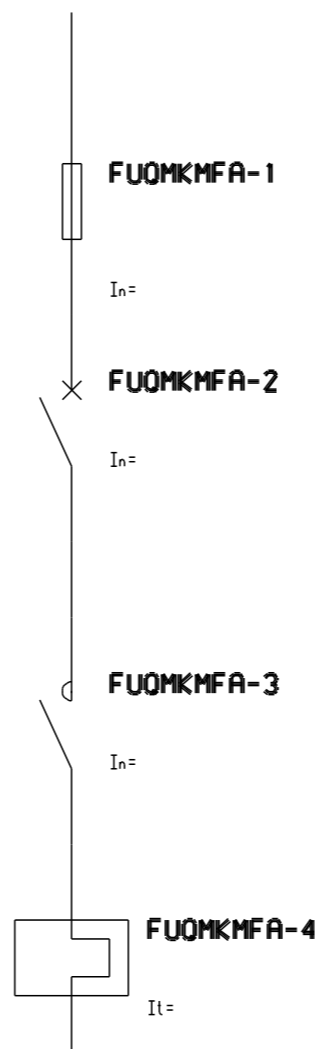
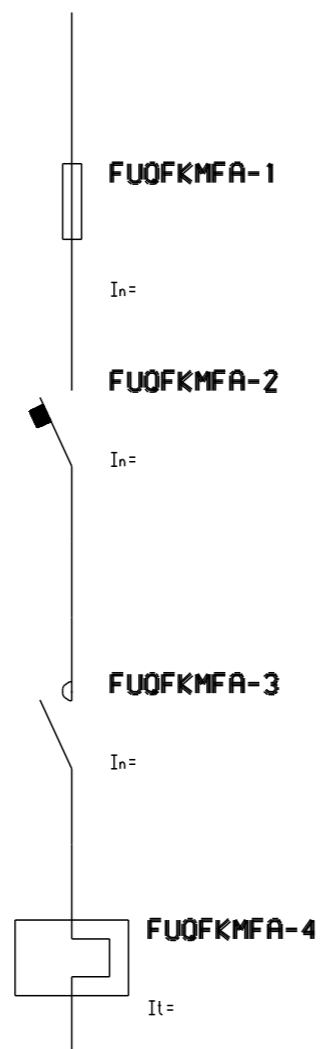
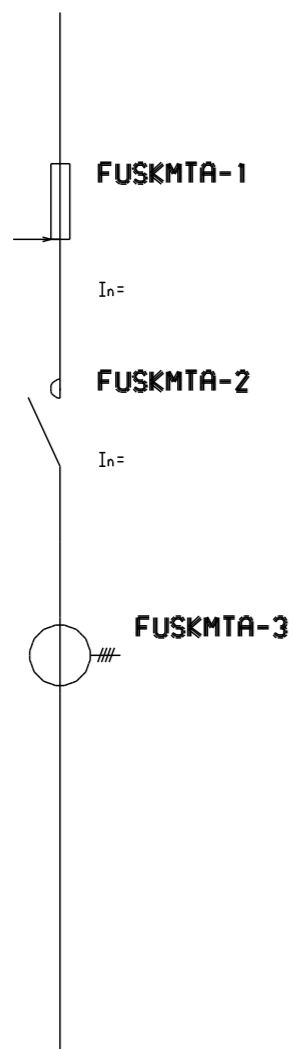
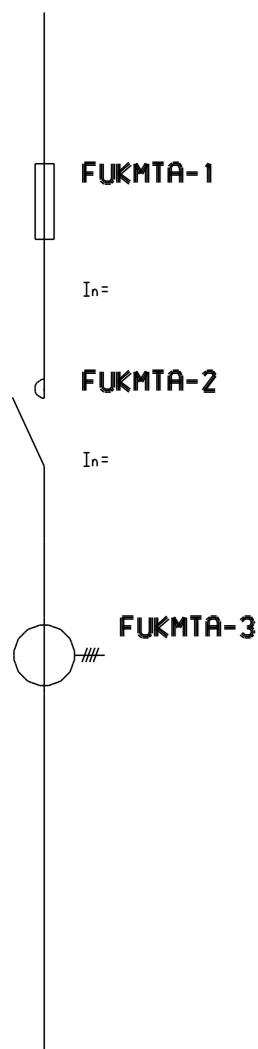

15.5.2000

15.5.2000

15.5.2000

19.5.2000

26.5.2000

FU<QF>

FUTFU

FUSKMFAN

FUKMFAN

FUSOMFAN

FUD

FUQFKM\R

**FU<QF>**

**FUTFU**

**FUSKMFAN**

**FUKMFAN**

**FUSOMFAN**

**FUD**

**FUQFKM\R**

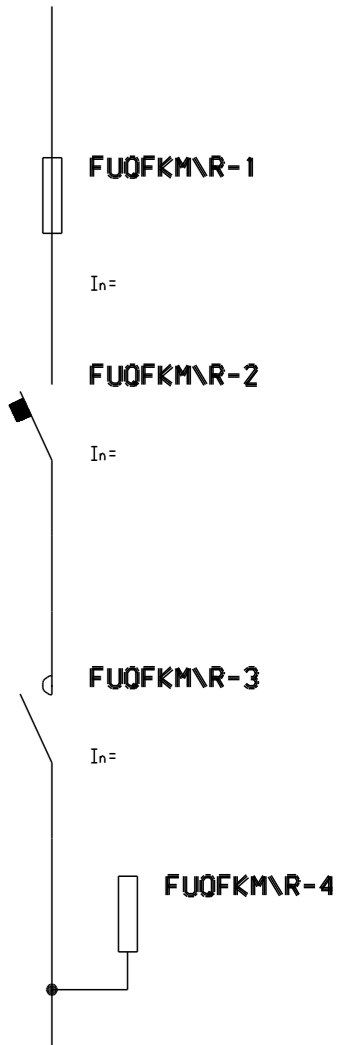
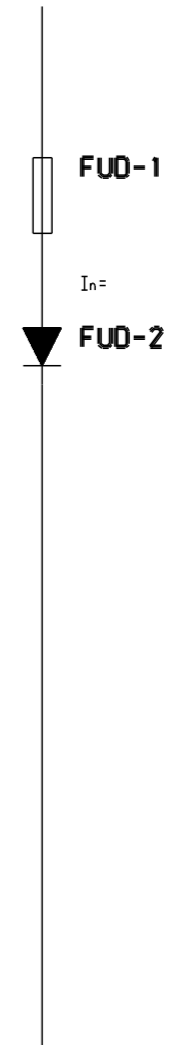
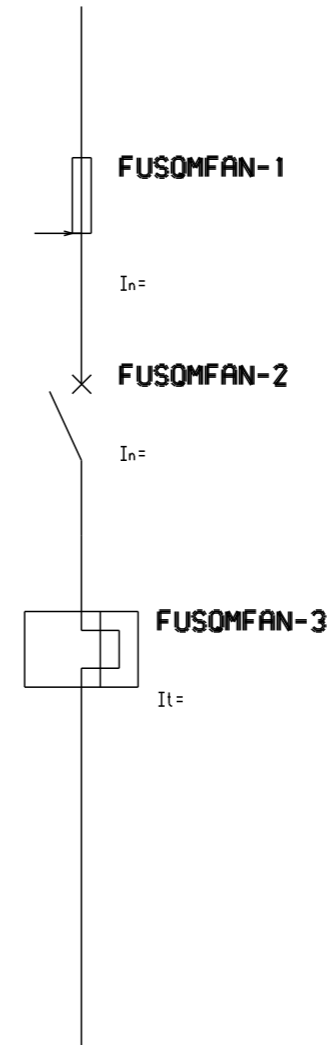
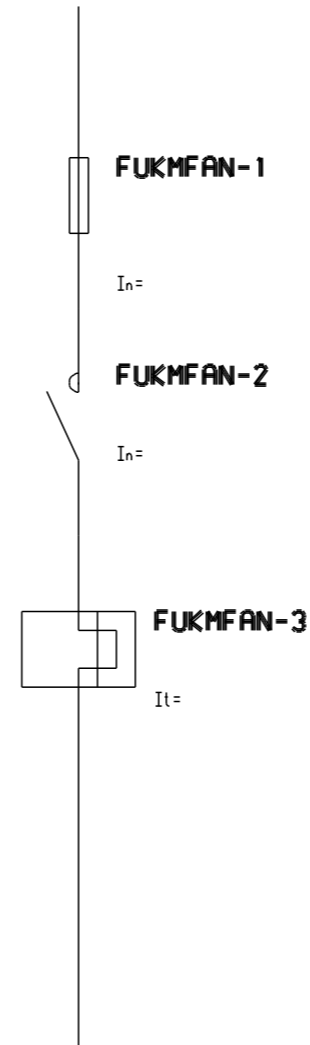
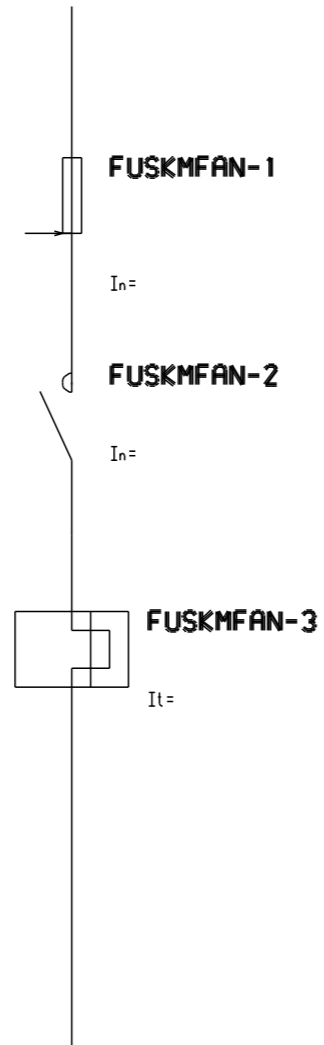
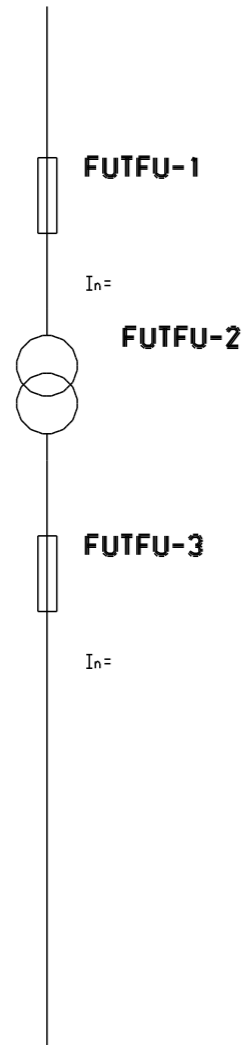
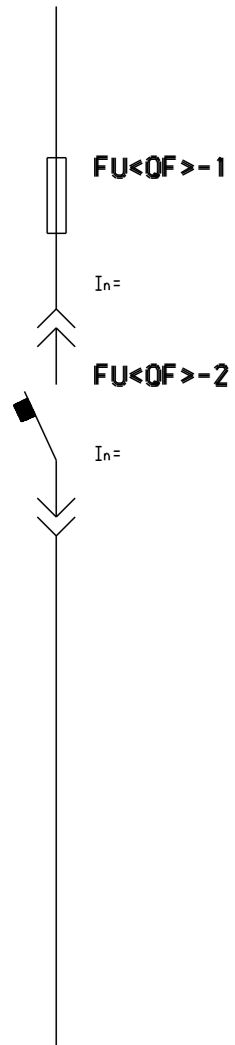

DOPLNEK: 26.5.2000  
 DOPLNEK: 19.5.2000  
 DOPLNEK: 15.5.2000  
 MANUAL JPS-POSLEDNI UPRAVA DNE 12.4.2000  
 ARCH. CÍSLO 4700-X-000100

**PRILOHA 2.1. TYPY ODBOCEK  
 ODBOCKY ZACINAJICI POJISTKOU-4**

6.6.2000

6.6.2000

13.6.2000

13.6.2000

FUZ

FUS<QM>

FUTOF

FUSFAKMFA

FUSKM2FA

FUSOMX

FUSOMPA

FUZ

FUS<QM>

FUTOF

FUSFAKMFA

FUSKM2FA

FUSOMX

FUSOMPA

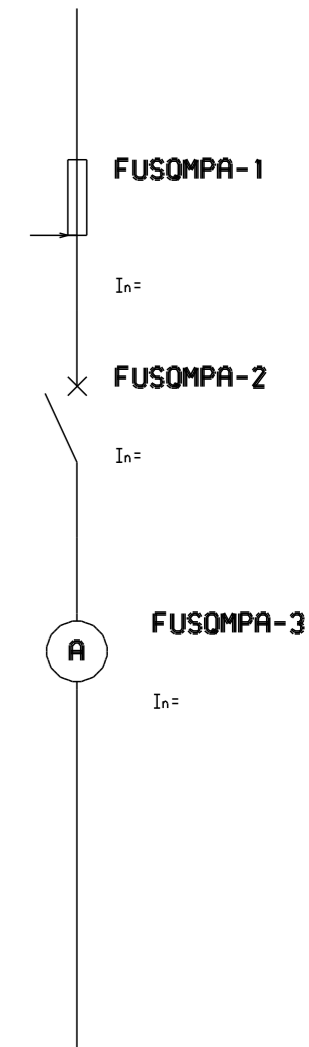
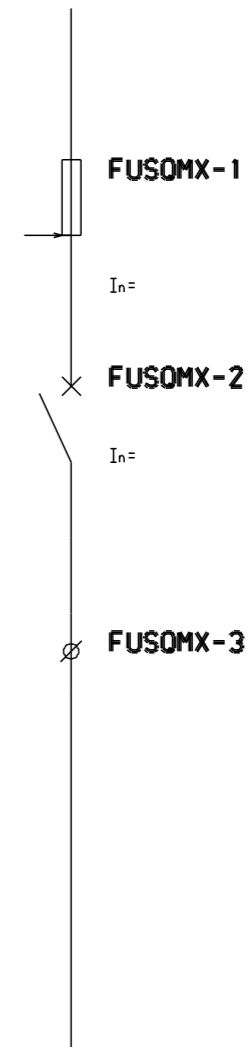
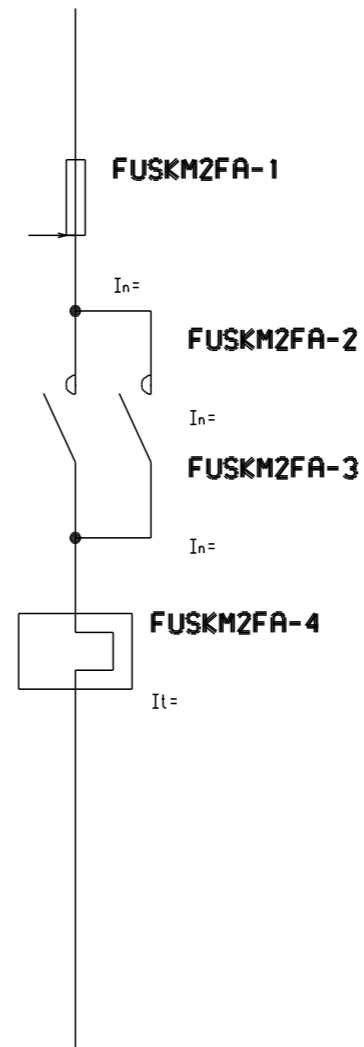
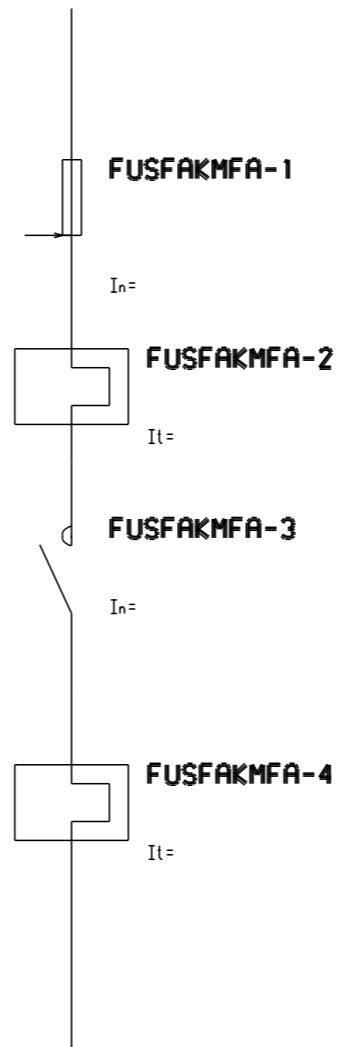
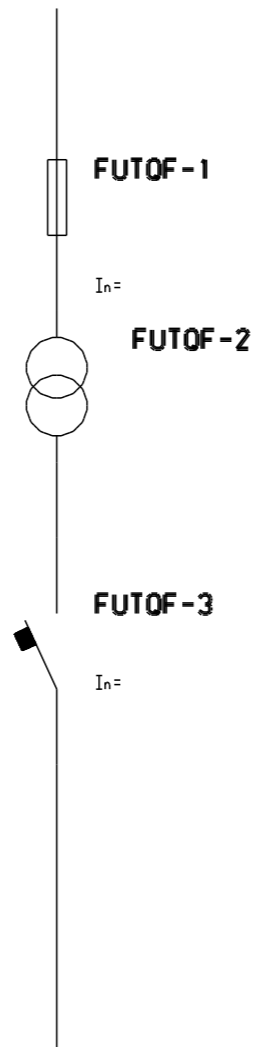
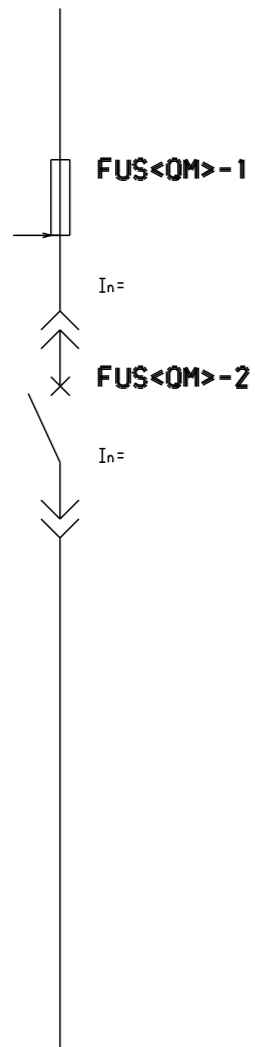
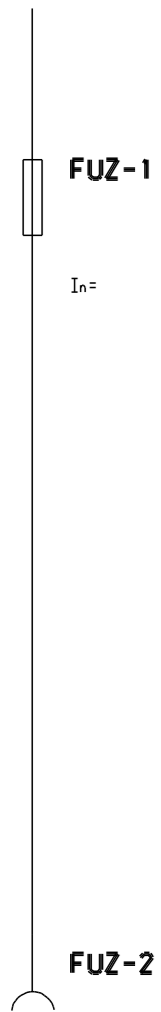

FUSFAKM

PRFUTA10M\FU

PRFUOMX

PRFUS<QM>\FUS

FUSZ

PRFUSOM

FUSFA

**FUSFAKM**

**PRFUTA10M\FU**

**PRFUOMX**

**PRFUS<QM>\FUS**

**FUSZ**

**PRFUSOM**

**FUSFA**

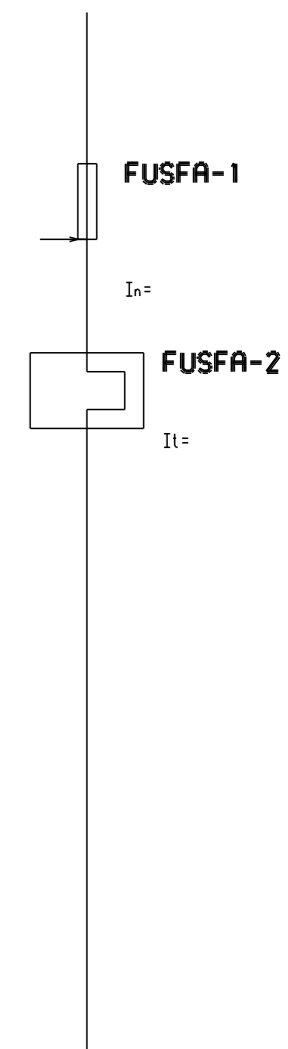
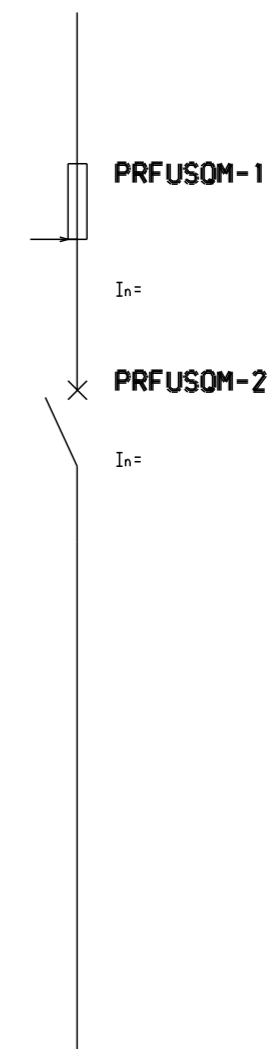
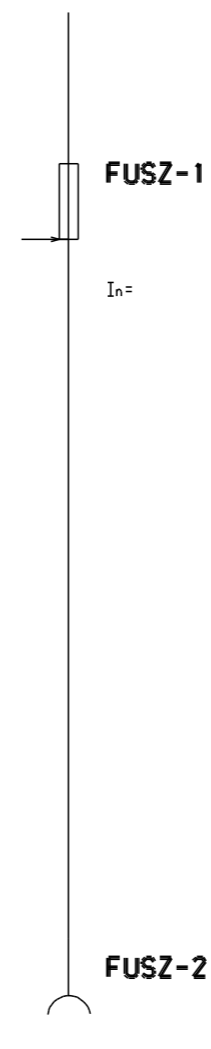
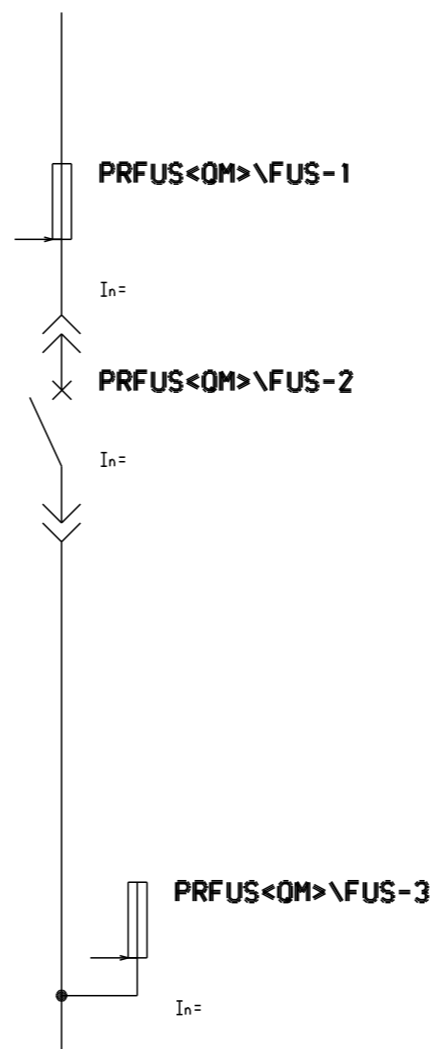
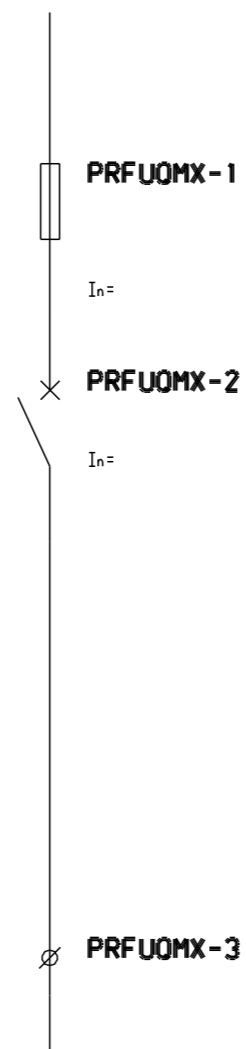
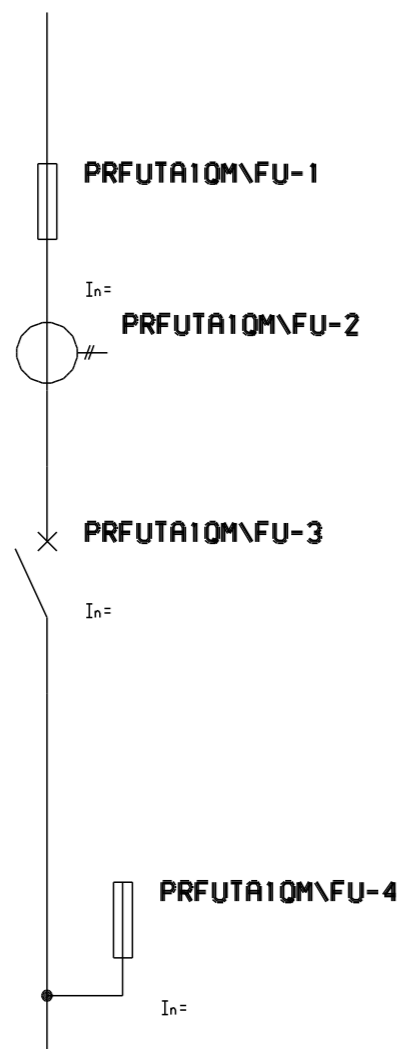
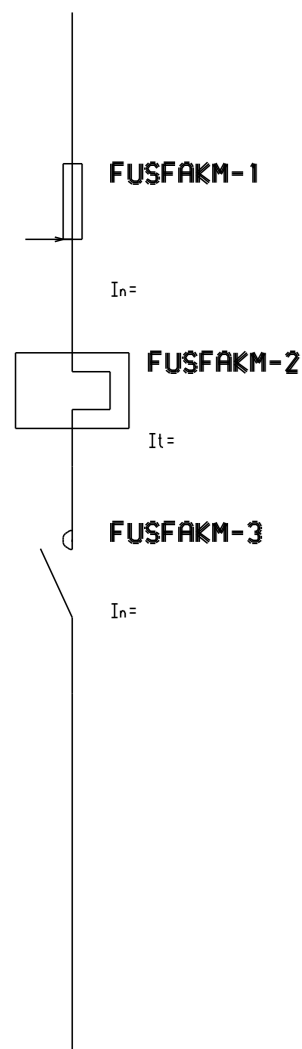

11.9.2000

14.9.2000

6.10.2000

PRFUTA1<QM>\FU

PRFUTA1<QM>\FU\

FUSQFKM\R

FUS<QF>

FUKM2FA

FUOMFI

FUSOMFI

PRFUTA1<QM>\FU

PRFUTA1<QM>\FU\OF

FUSQFKM\R

FUS<QF>

FUKM2FA

FUOMFI

FUSOMFI

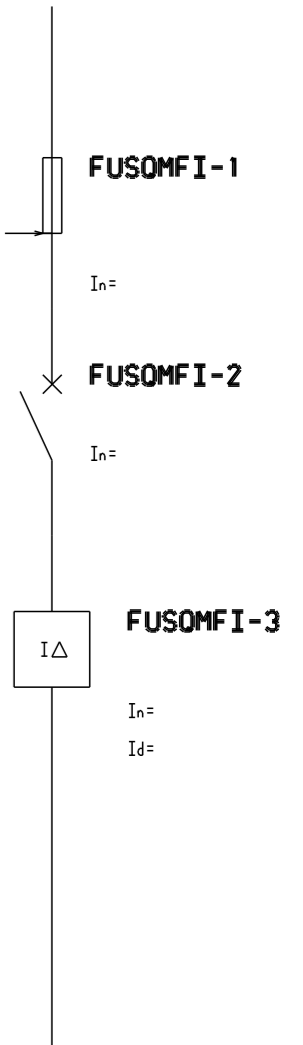
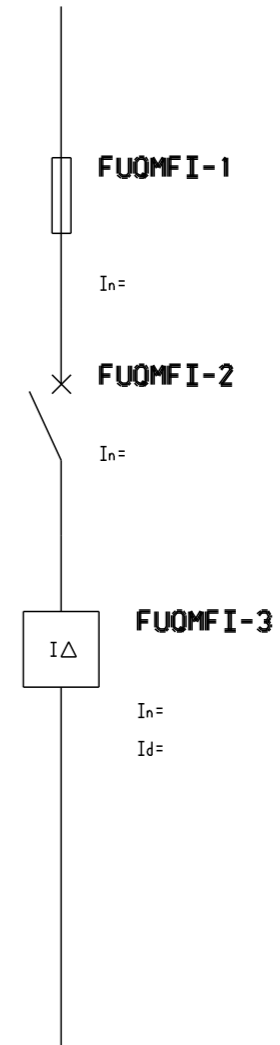
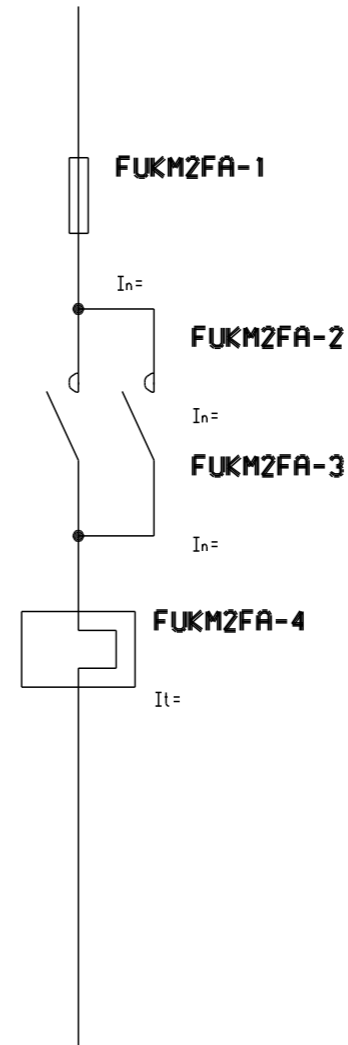
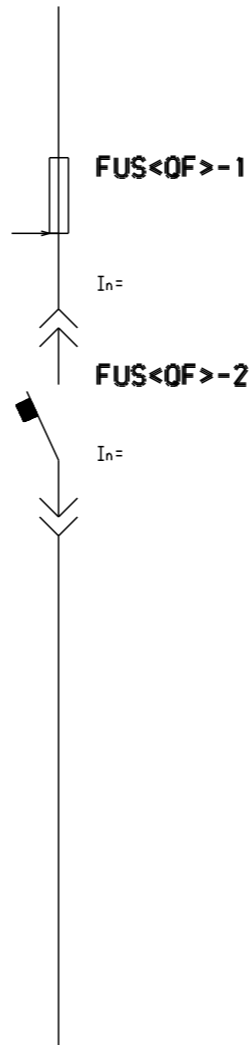
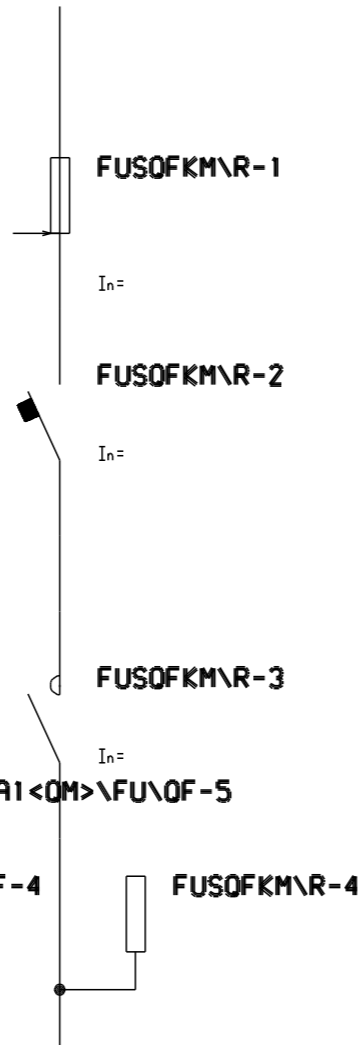
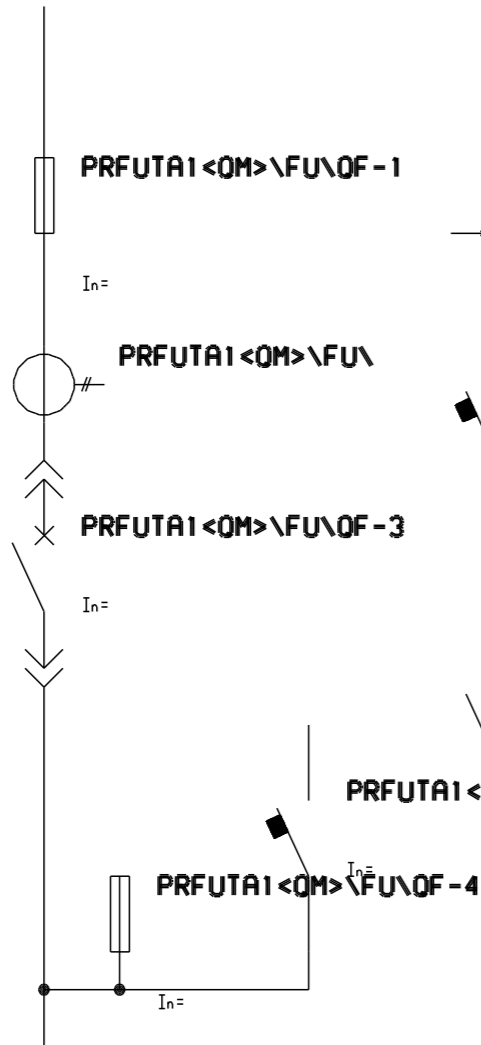
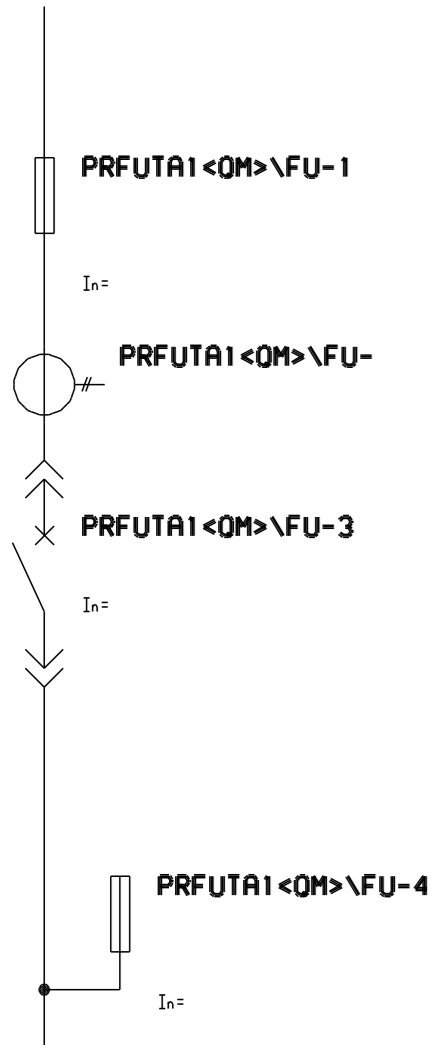

PRFUS<QM>RA\FUS

FUS<QM>RA

FUSQKMFA

PRFU

FUKM\IL10F

### PRFUS<QM>RA\FUS

### FUS<QM>RA

### FUSQKMFA

### PRFU

### FUKM\IL10F

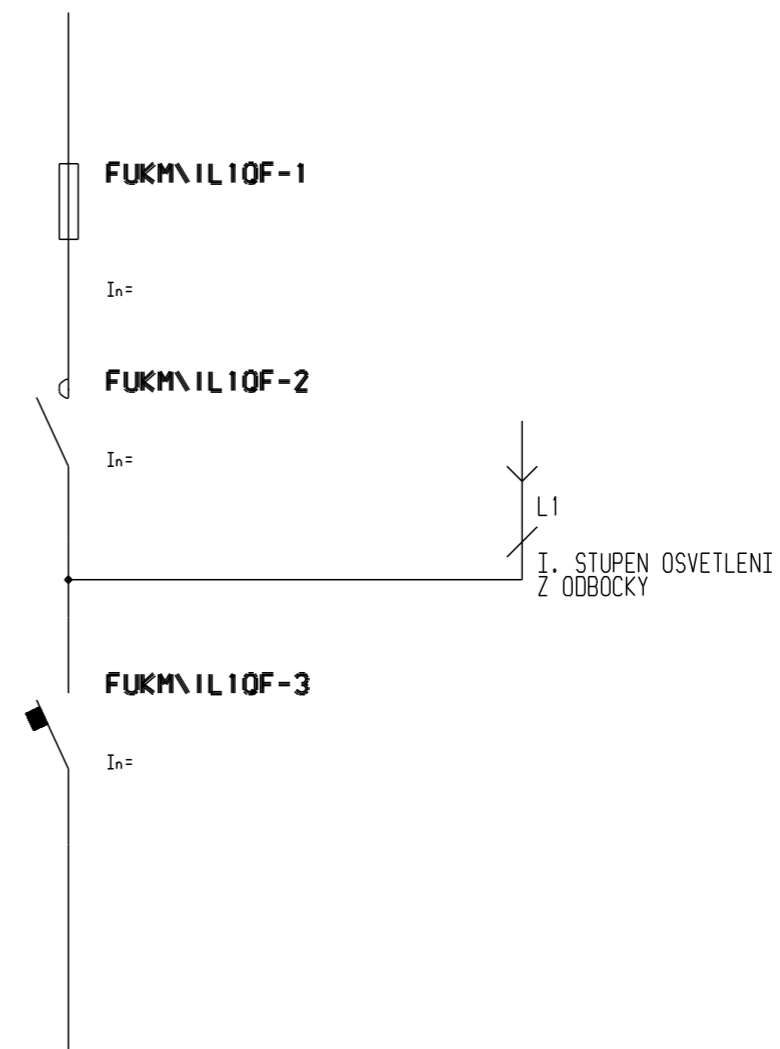
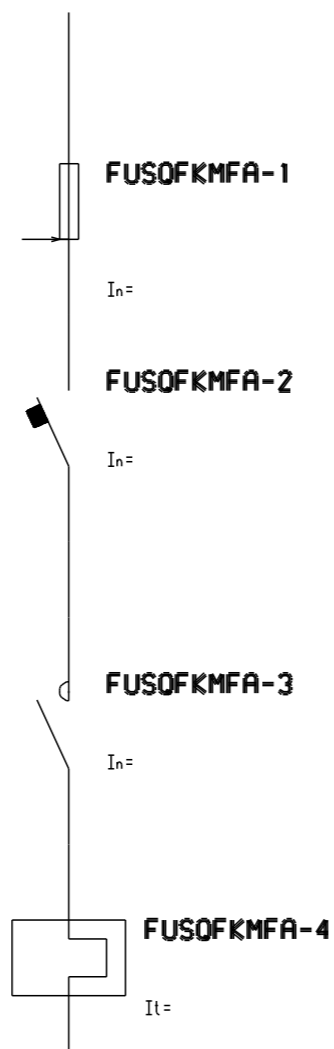
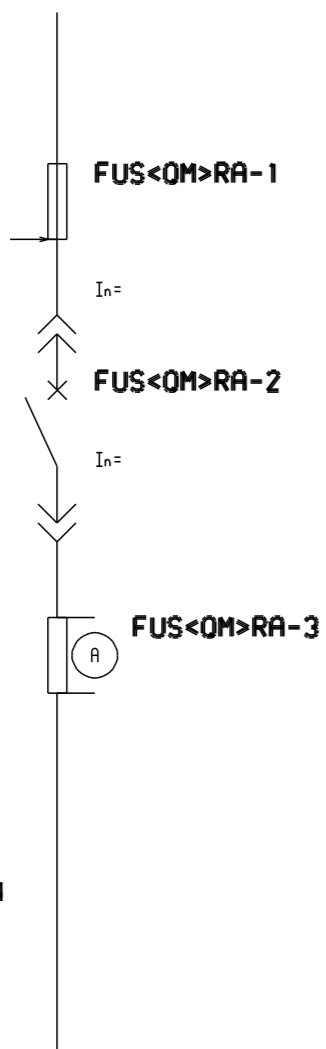
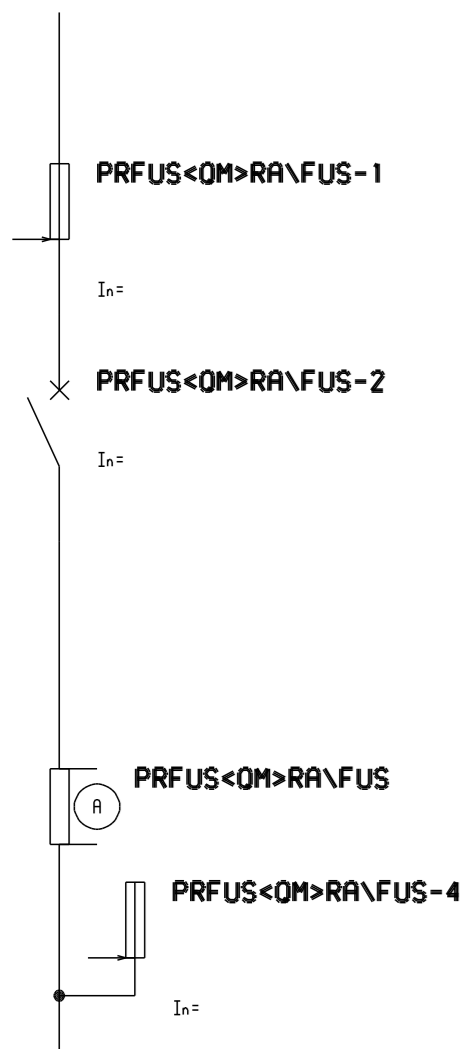

FUKM\IL10F - 2 MODULY



FUKM\IL20F

FUKM\IL30F

FUKML123

FUKML1

FUS\OF

# FUKM\IL20F

# FUKM\IL30F

# FUKML123

# FUKML1

# FUS\OF

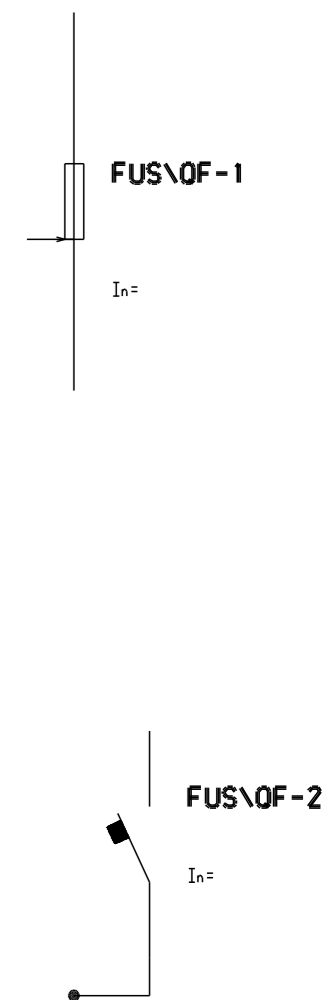
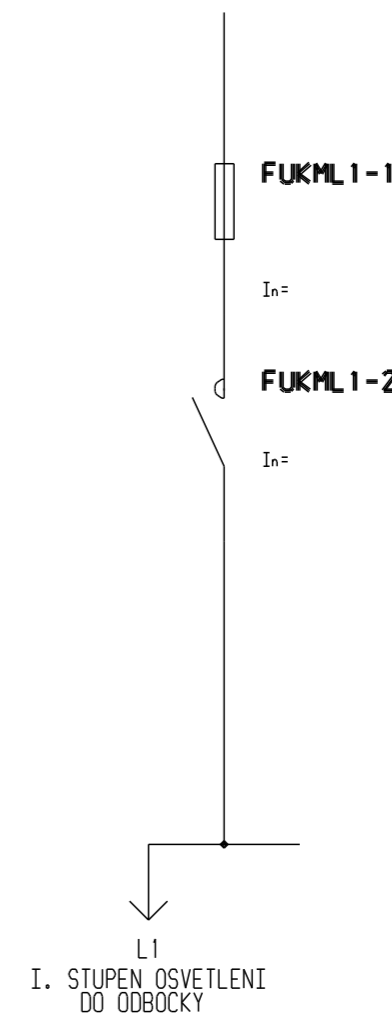
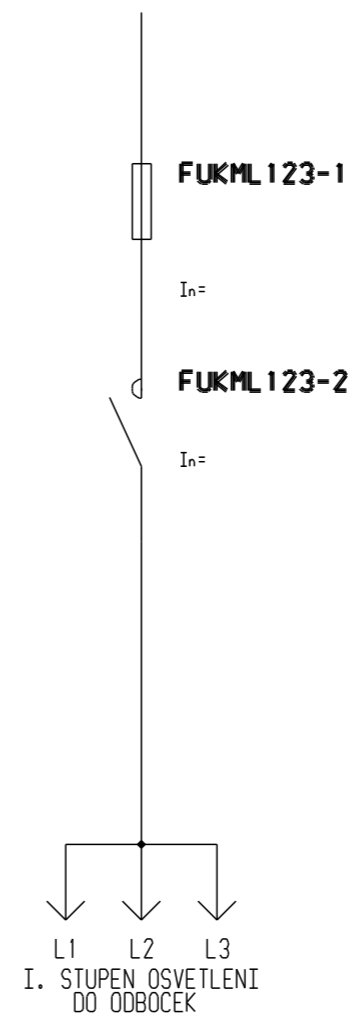
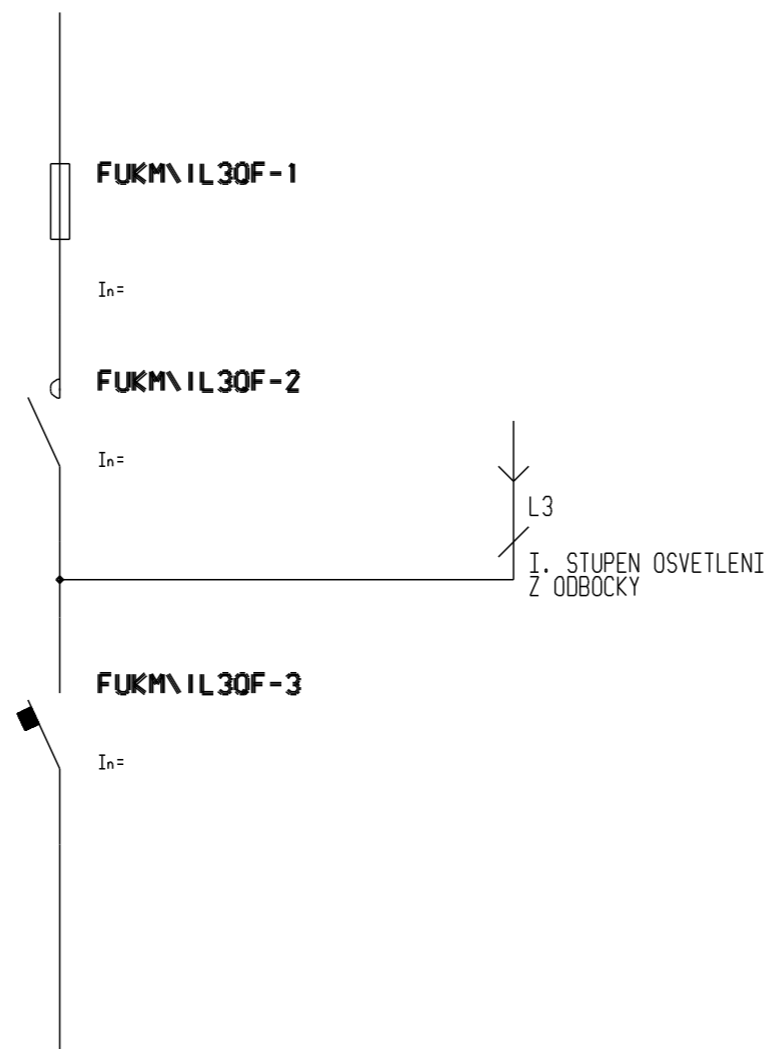
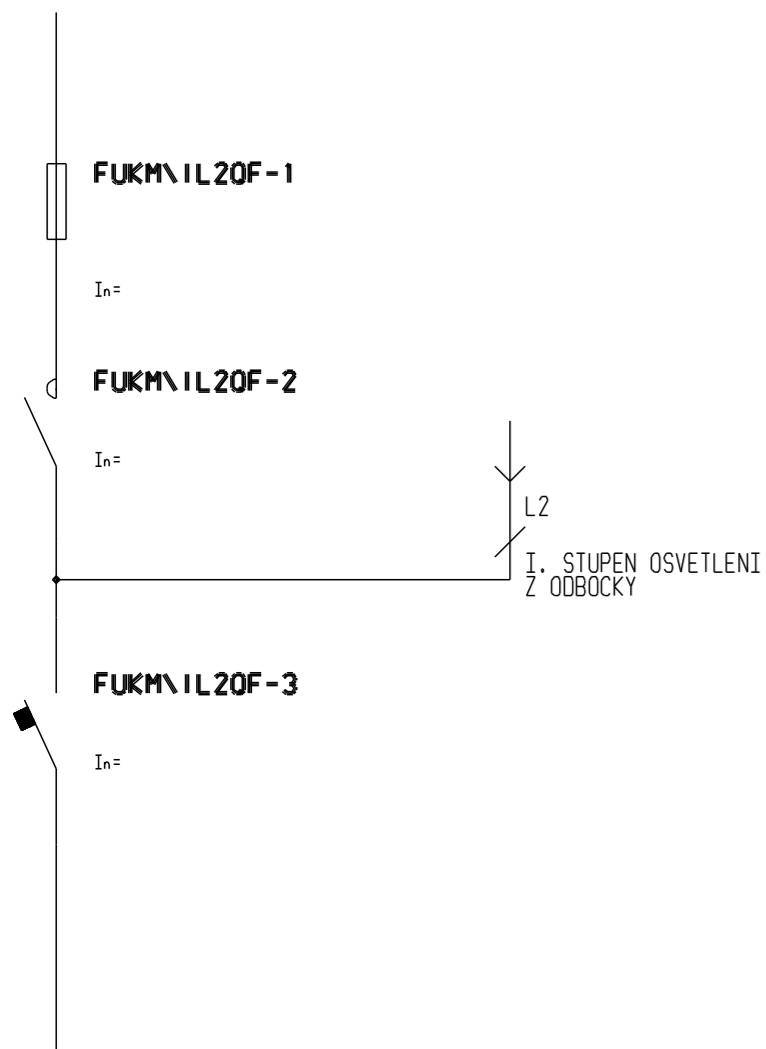

FUKM\IL20F - 2 MODULY

FUKM\IL30F - 2 MODULY

PRFUS<QF>\FUS

FUS<QF>TA

PRFUS<QF>TA1\FU

FUSQFTA

FU\FAKM

FUOFOM

### PRFUS<QF>\FUS

### FUS<QF>TA

### PRFUS<QF>TA1\FUS

### FUSQFTA

### FU\FAKM

### FUOFOM

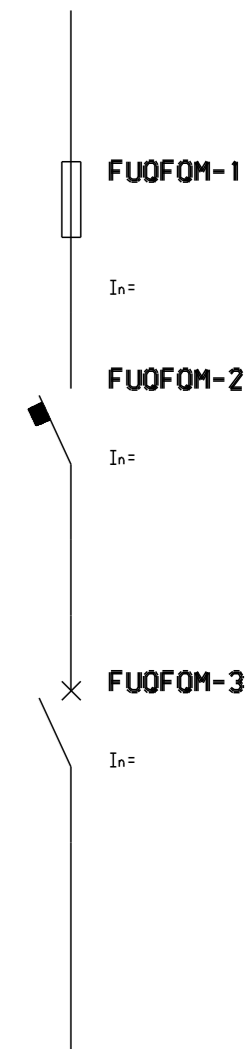
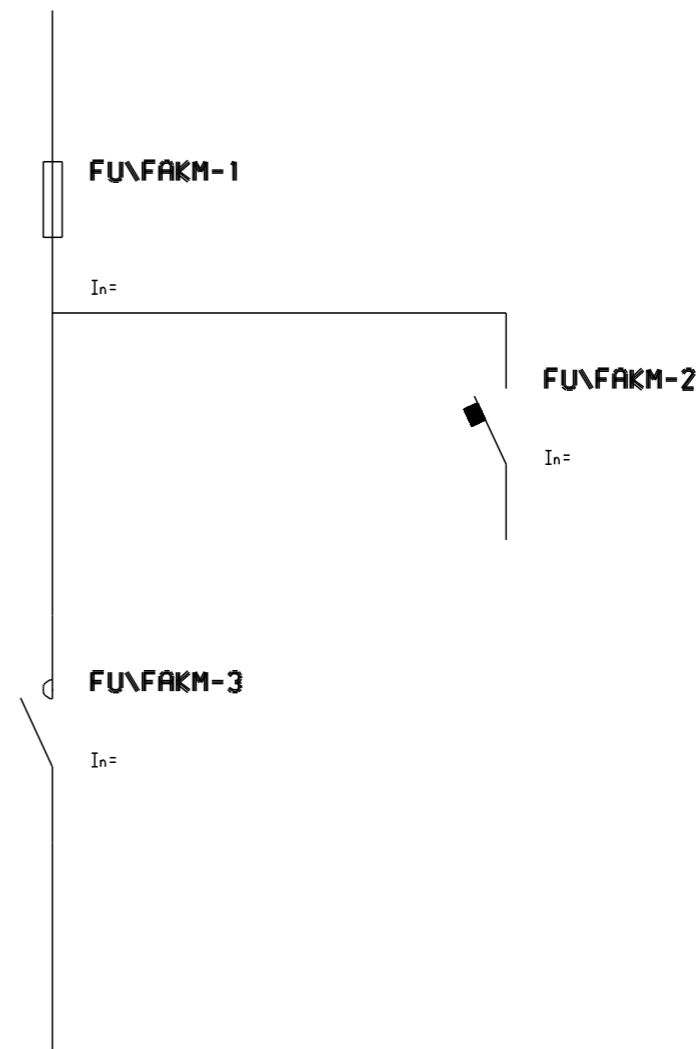
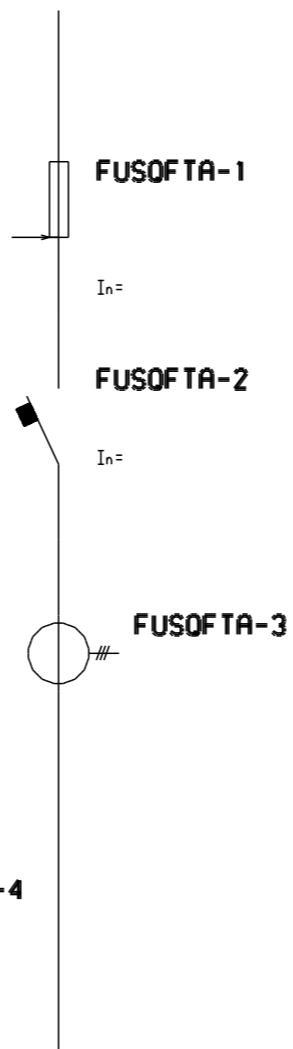
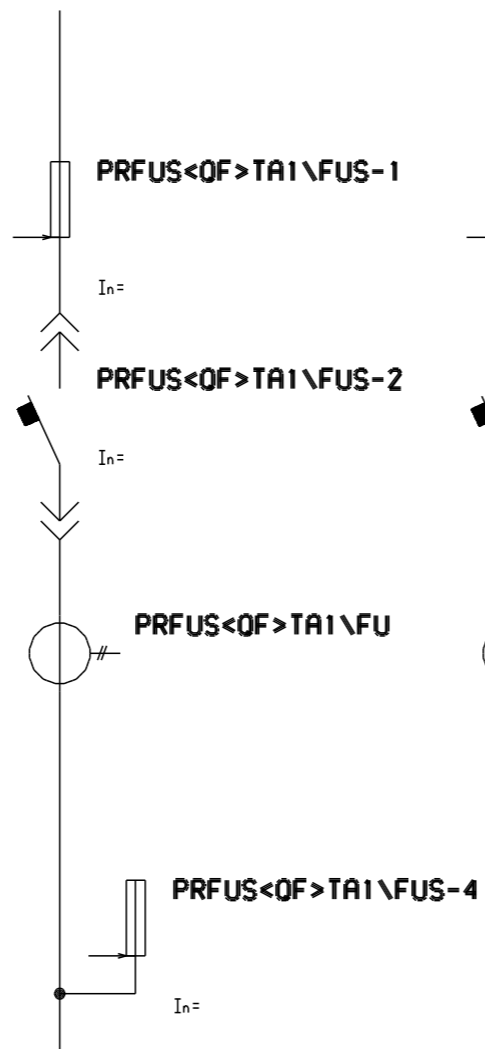
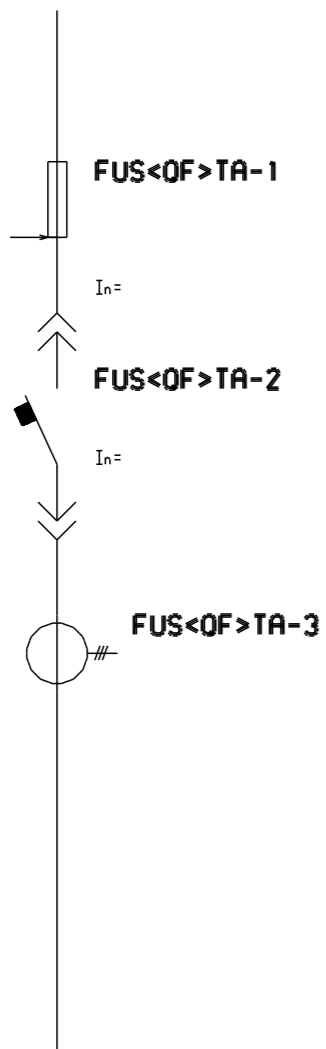
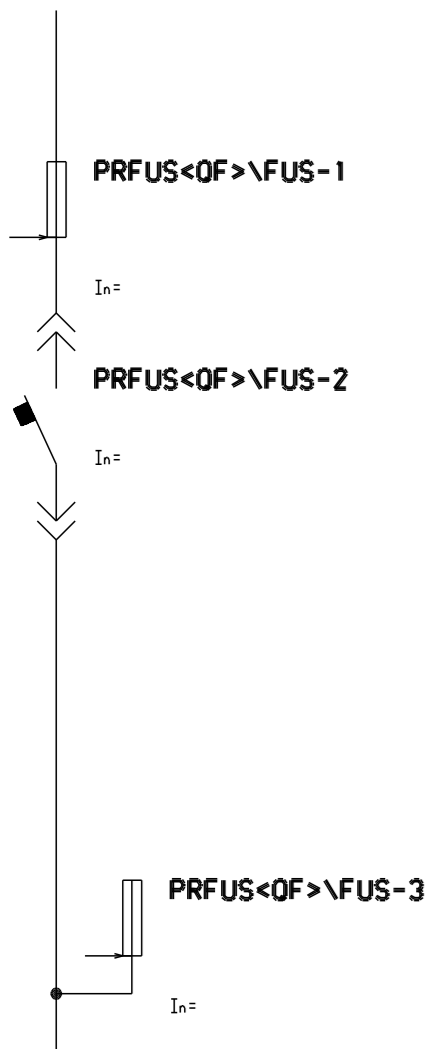

FU\FAKM - 2 MODULY

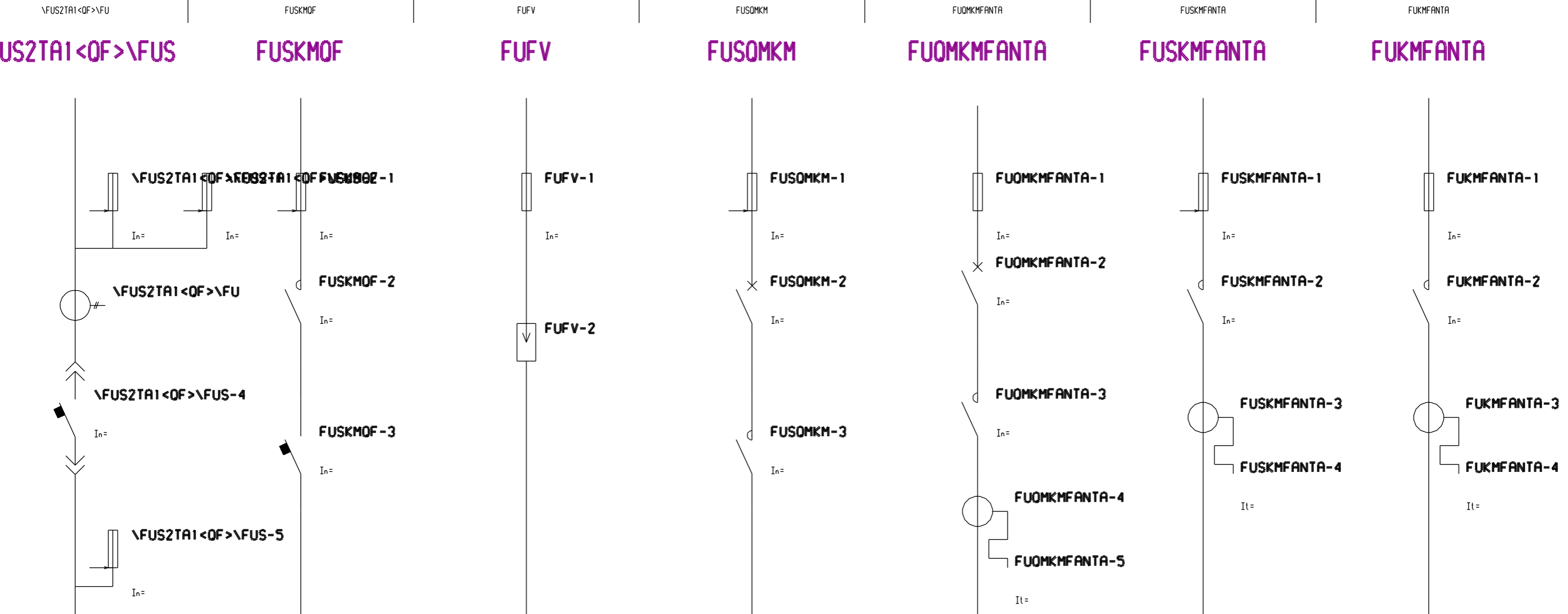

FUSQMFANTA

FUSQFKM\KM2

FUZV

FUSZV

FUTFUZ

FUQFKM2

# FUSQMFANTA

# FUSQFKM\KM2

# FUZV

# FUSZV

# FUTFUZ

# FUQFKM2

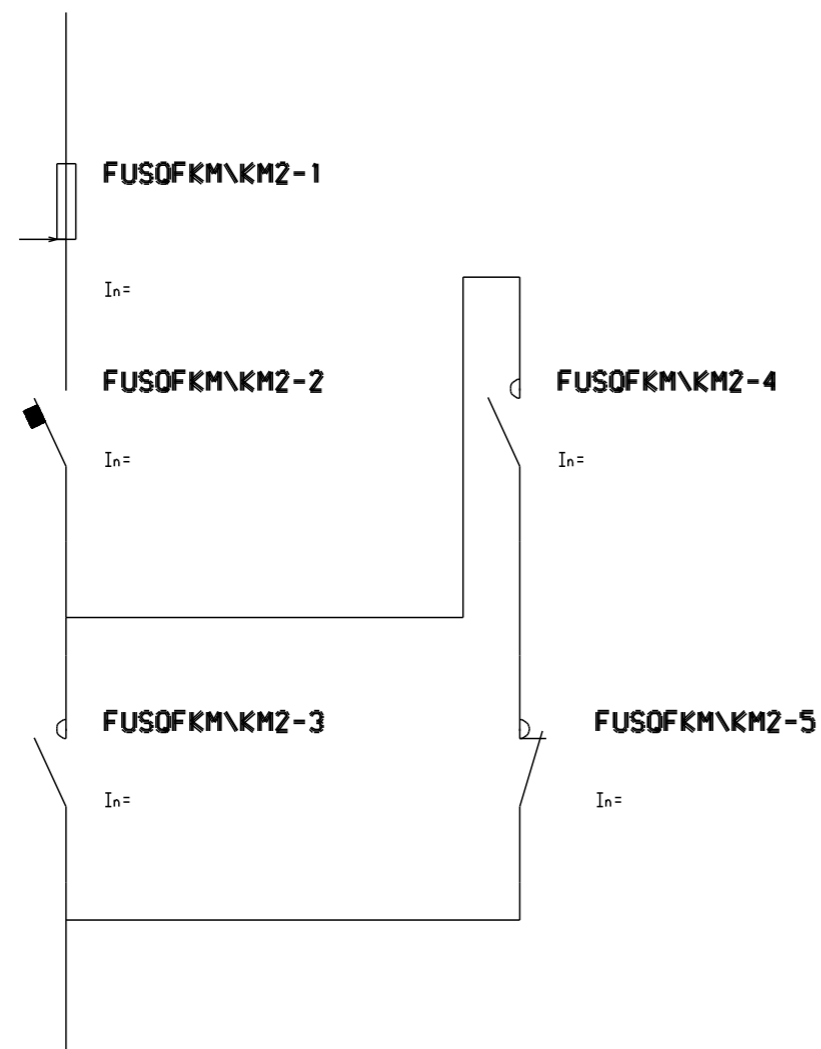
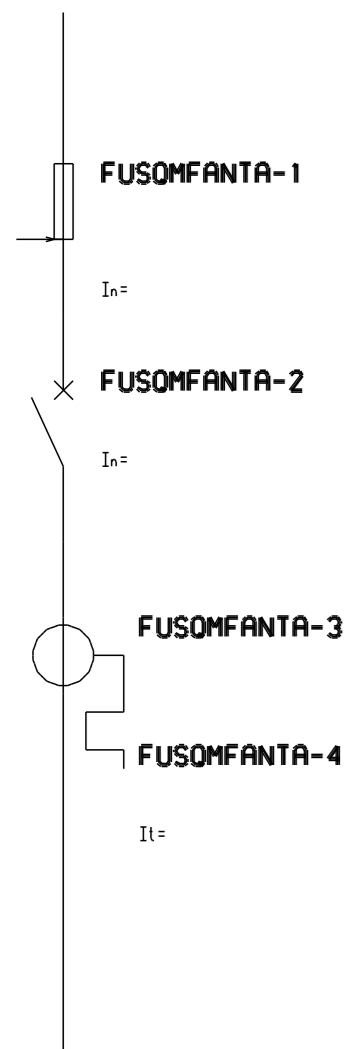

FUSQFKM\KM2 - 2 MODULY

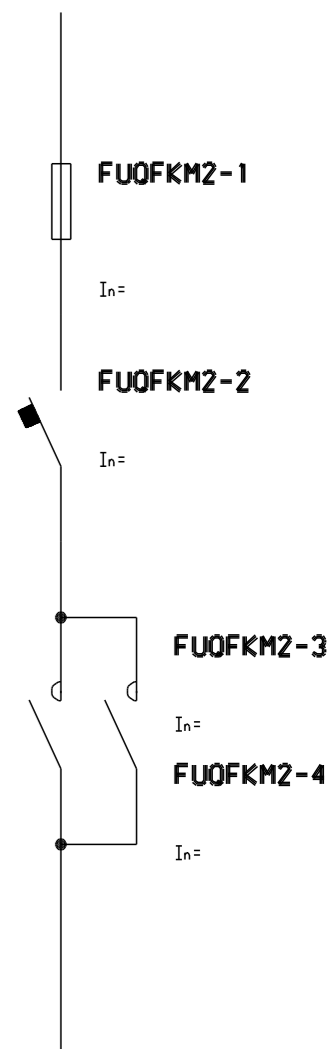
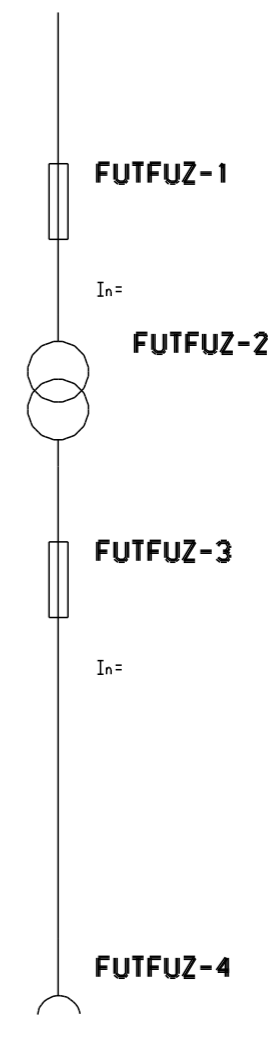
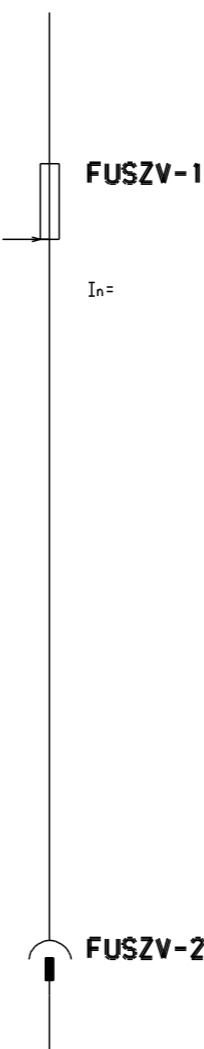
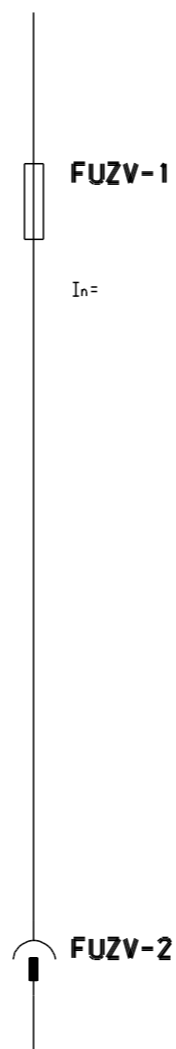

FUOMOF

FUOFZ

FUT

FUOMTFUZ

FUOFFIZ

FUOM\

### FUOMOF

### FUOFZ

### FUT

### FUOMTFUZ

### FUOFFIZ

### FUOM\

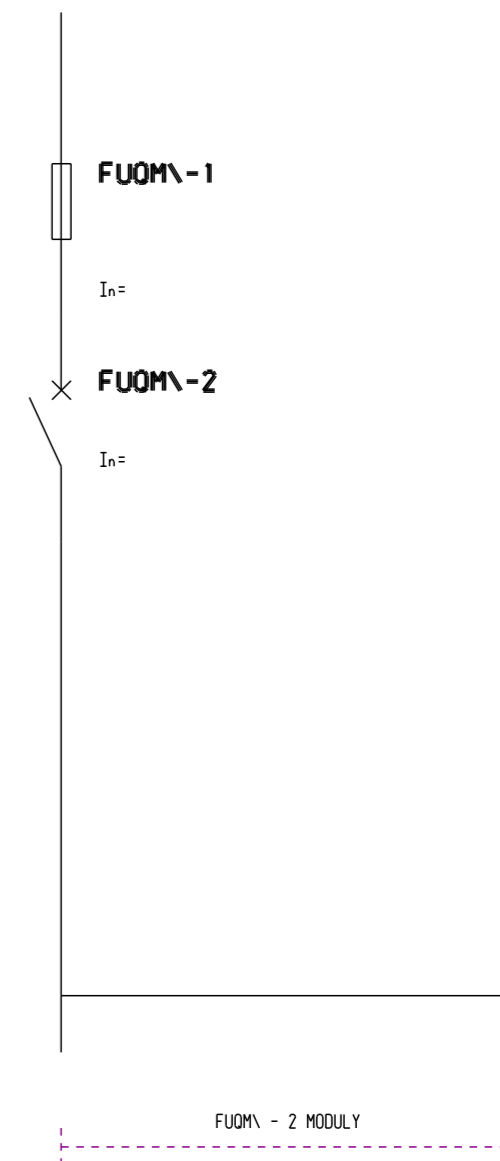
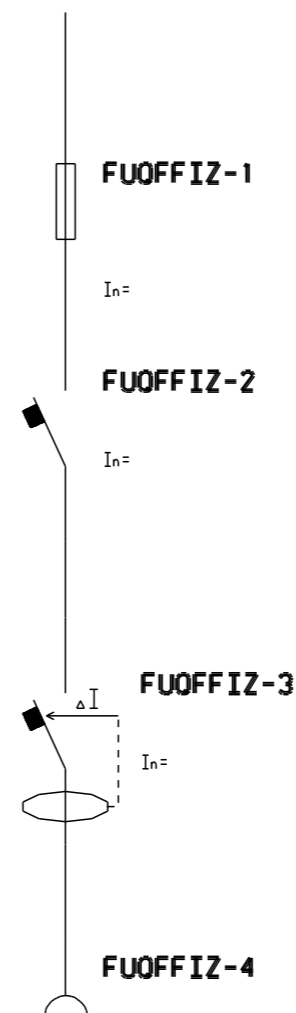
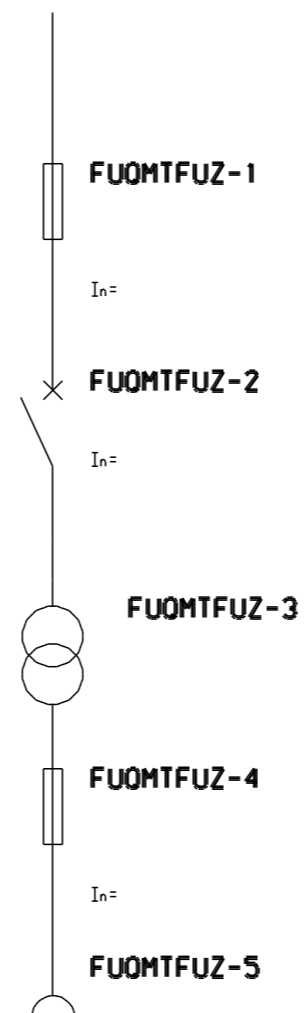
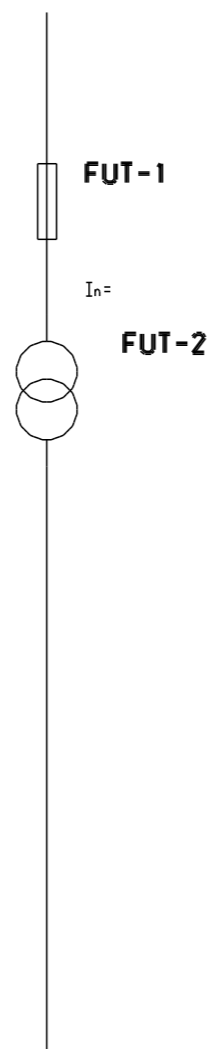
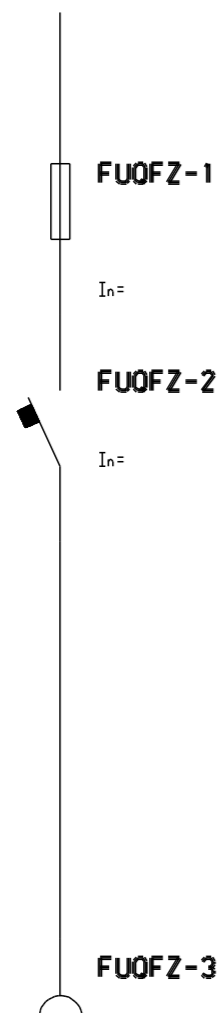
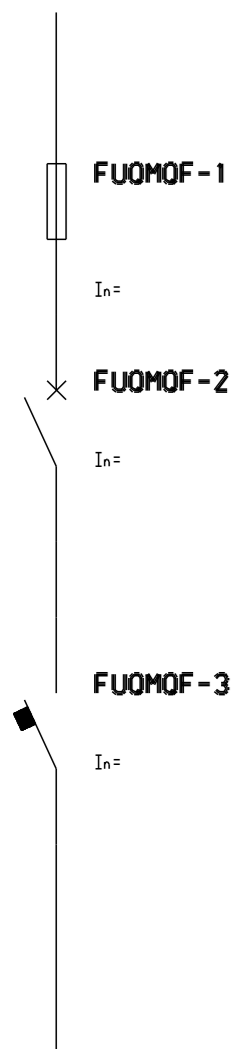

FUKMOF6\OF

FUSKMFX

# FUKMOF6\OF

# FUSKMFX

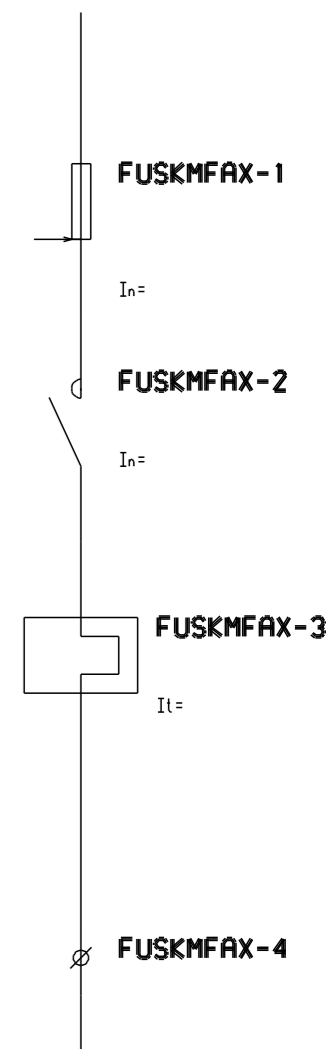
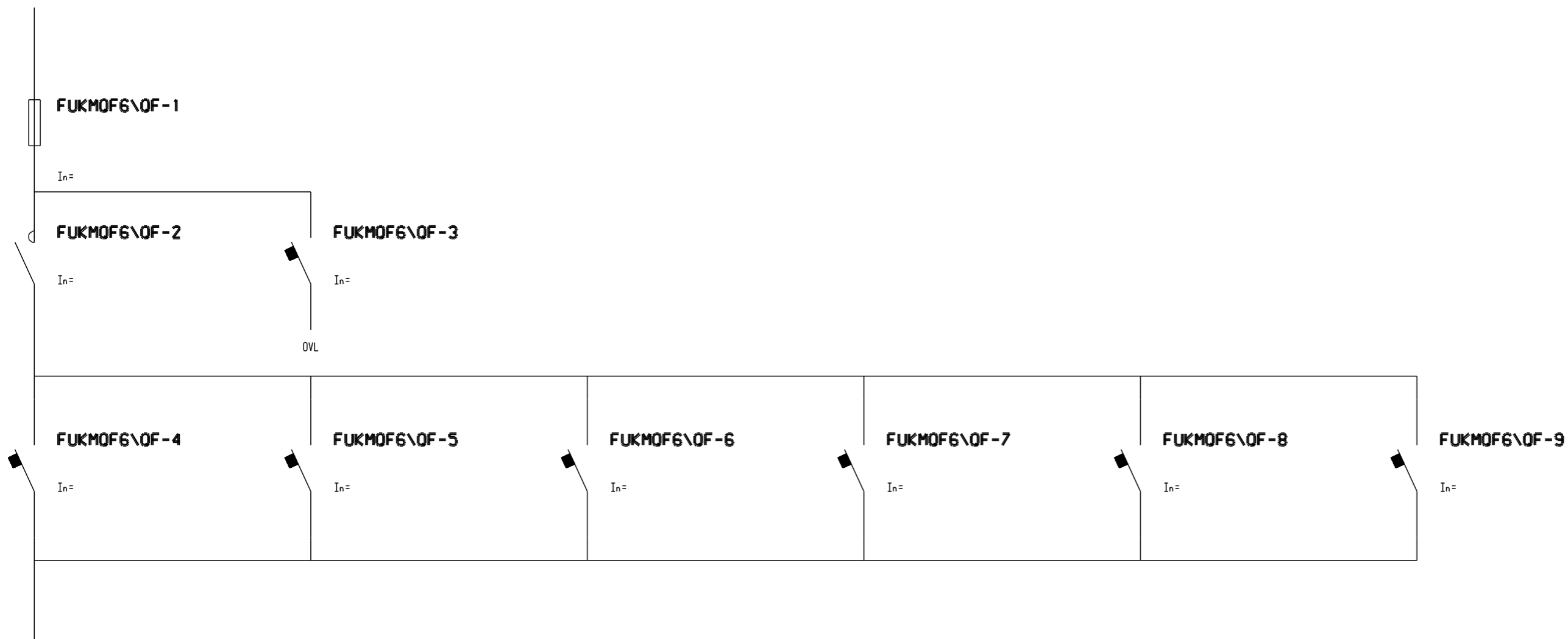

FUKMOF6\OF - 6 MODULU

FUKMFAN\KM\KM

# FUKMFAN\KM\KM

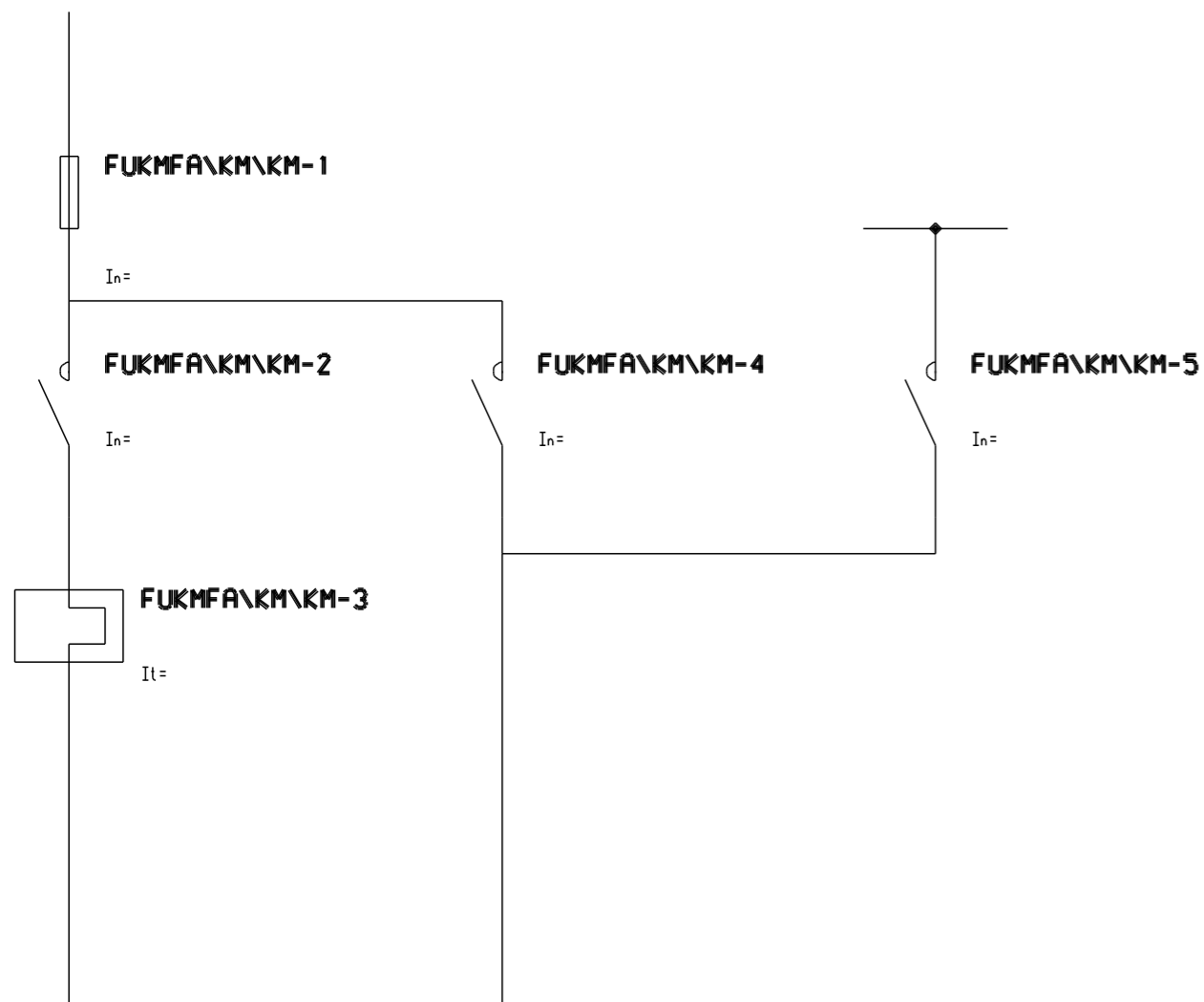

FUKMFAN\KM\KM - 3 MODULY

FUSOVL

# FUSOVL

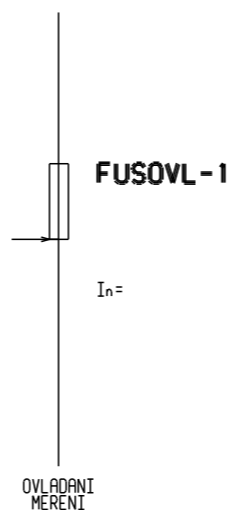

FU\

# FU\

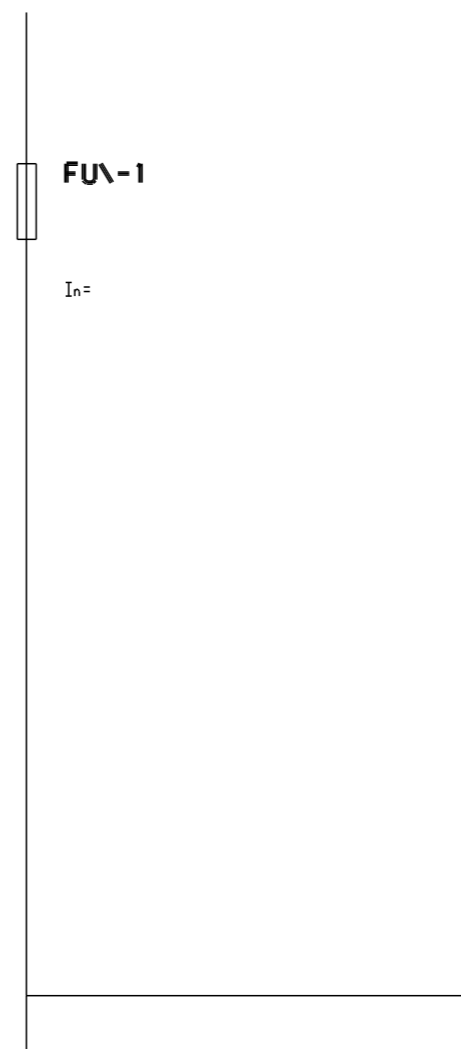

FU\ - 2 MODULY

FUOVL

# FUOVL

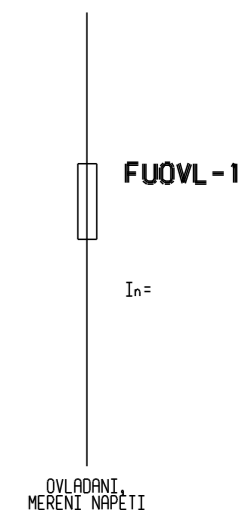

FUKMOF6\OF\OF

FUSX

# FUKMOF6\OF\OF

# FUSX

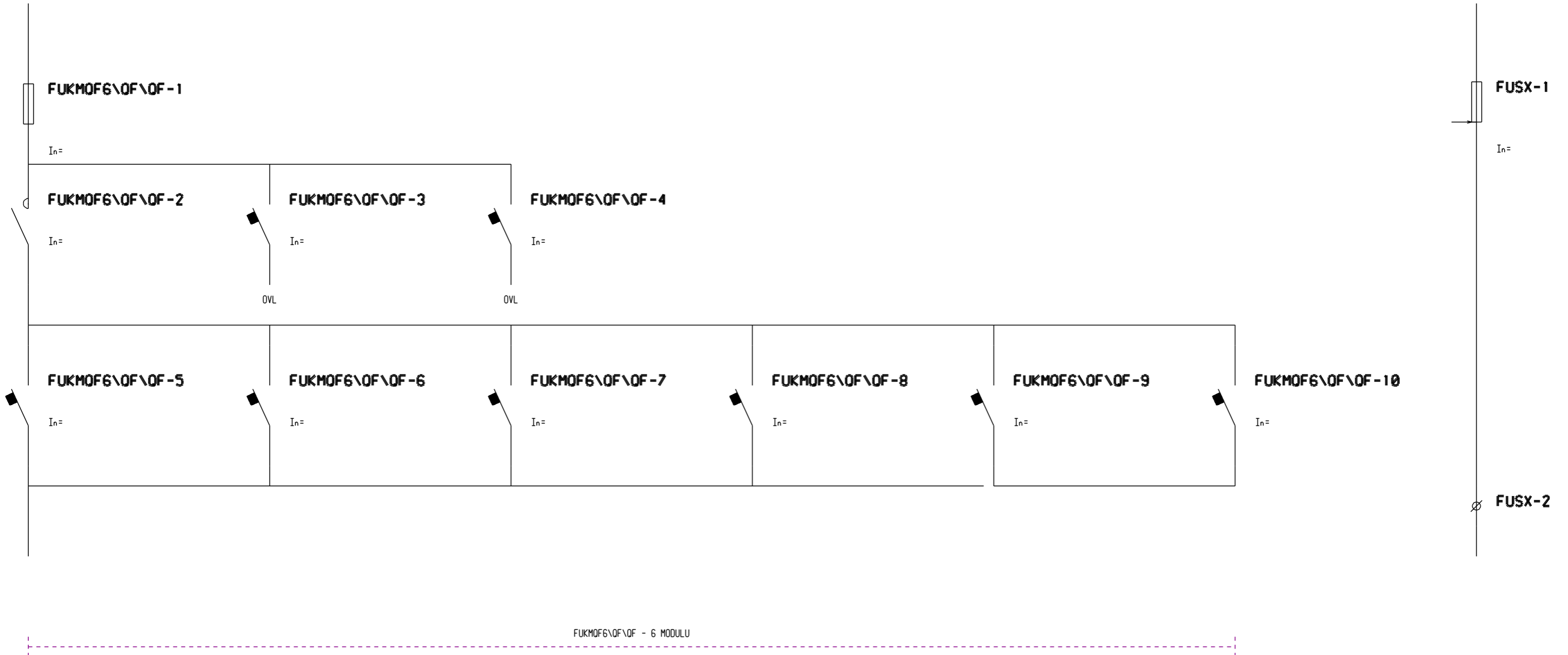



FU\QFQ\KM

FUKMFA\KMFA

PRFUQM

FUKA

FUQVLBP

### FU\QFQ\KM

### FUKMFA\KMFA

### PRFUQM

### FUKA

### FUQVLBP

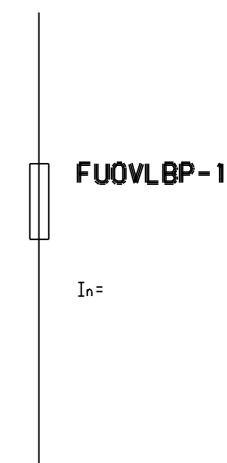
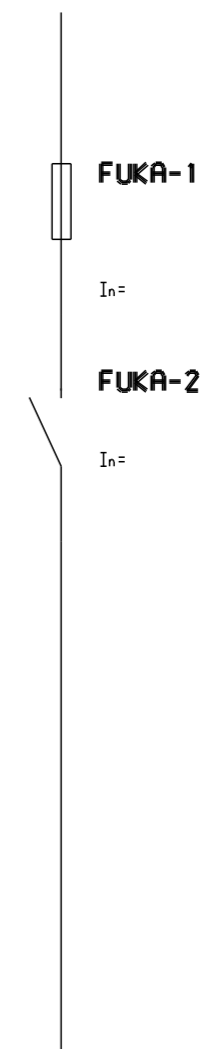
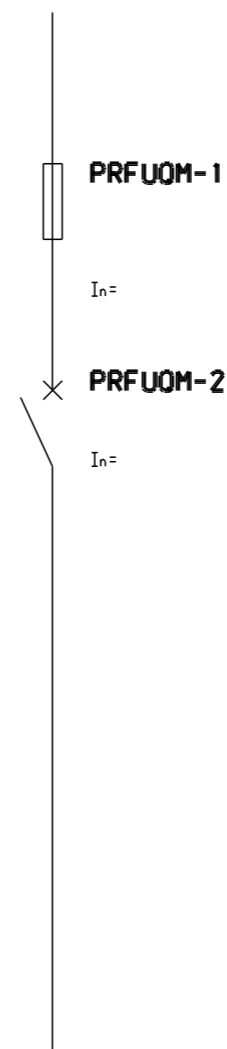
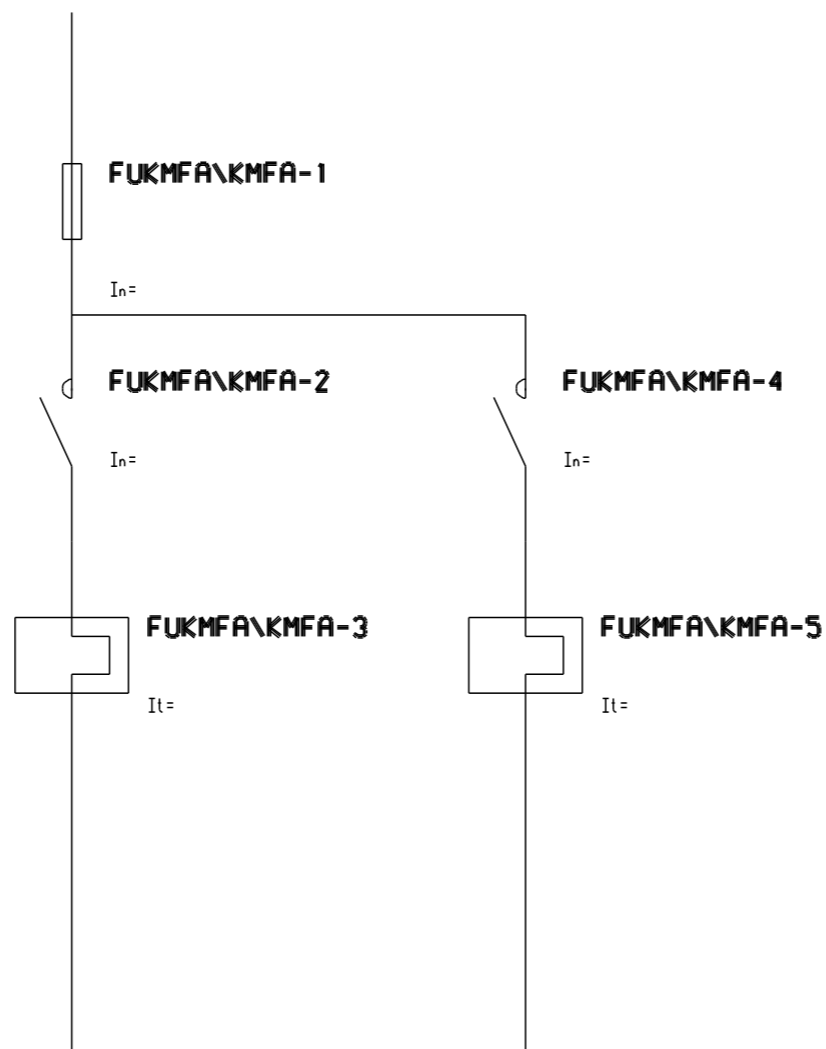
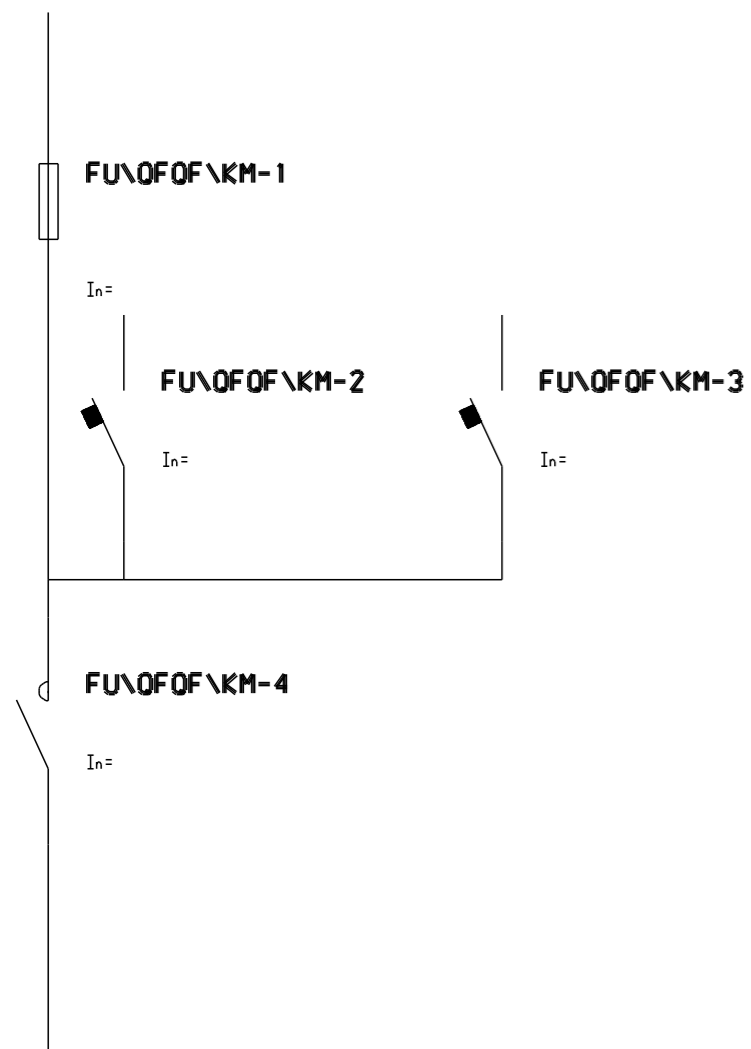

FU\QFQ\KM - 2 MODULY

FUKMFA\KMFA - 2 MODULY

FUKMFA\FU

PRFUKMOM

FUOM\OF

FUOVLKM

FUSOVLBP

# FUKMFA\FU

# PRFUKMOM

# FUOM\OF

# FUOVLKM

# FUSOVLBP

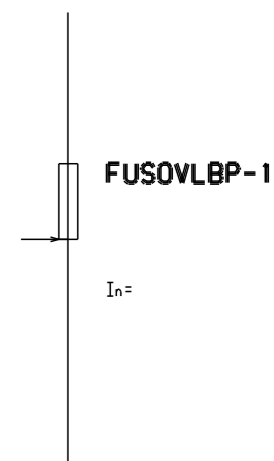
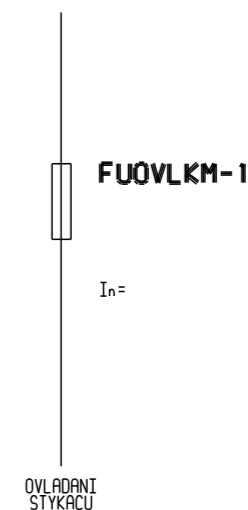
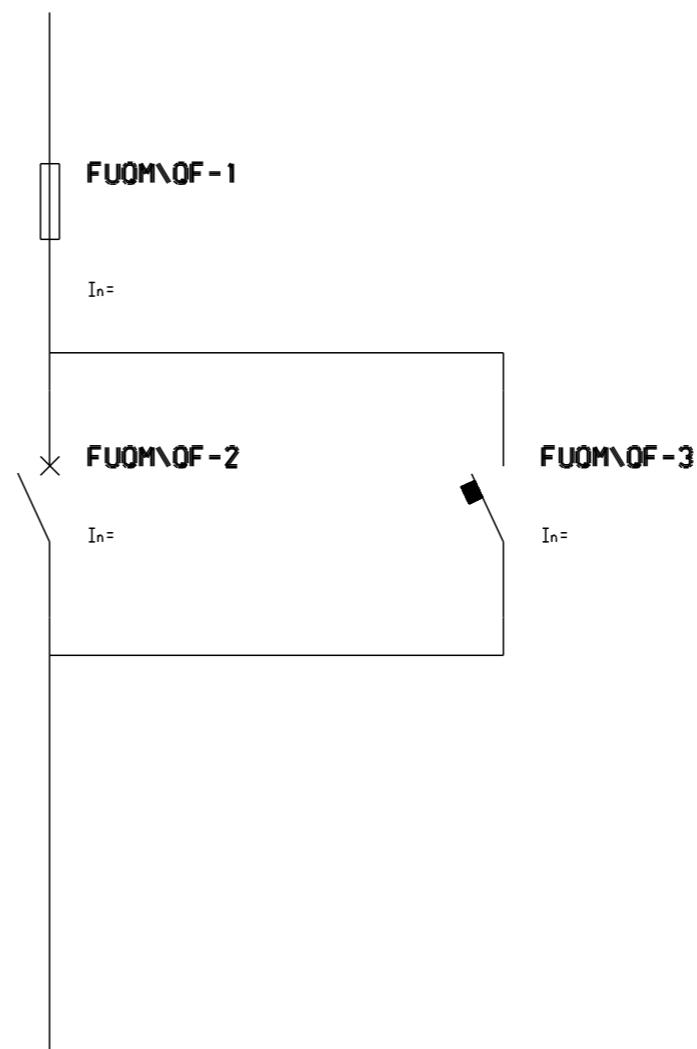
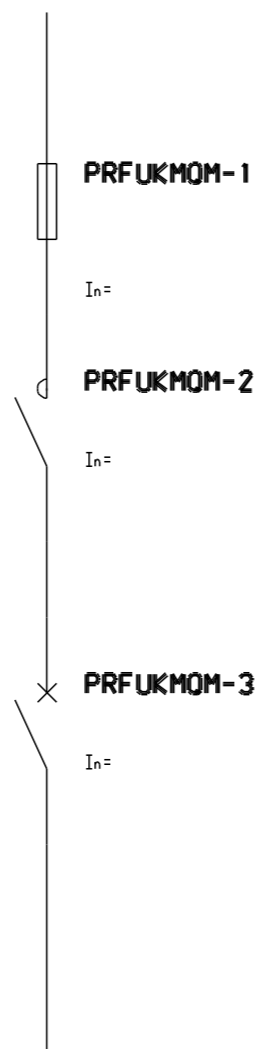
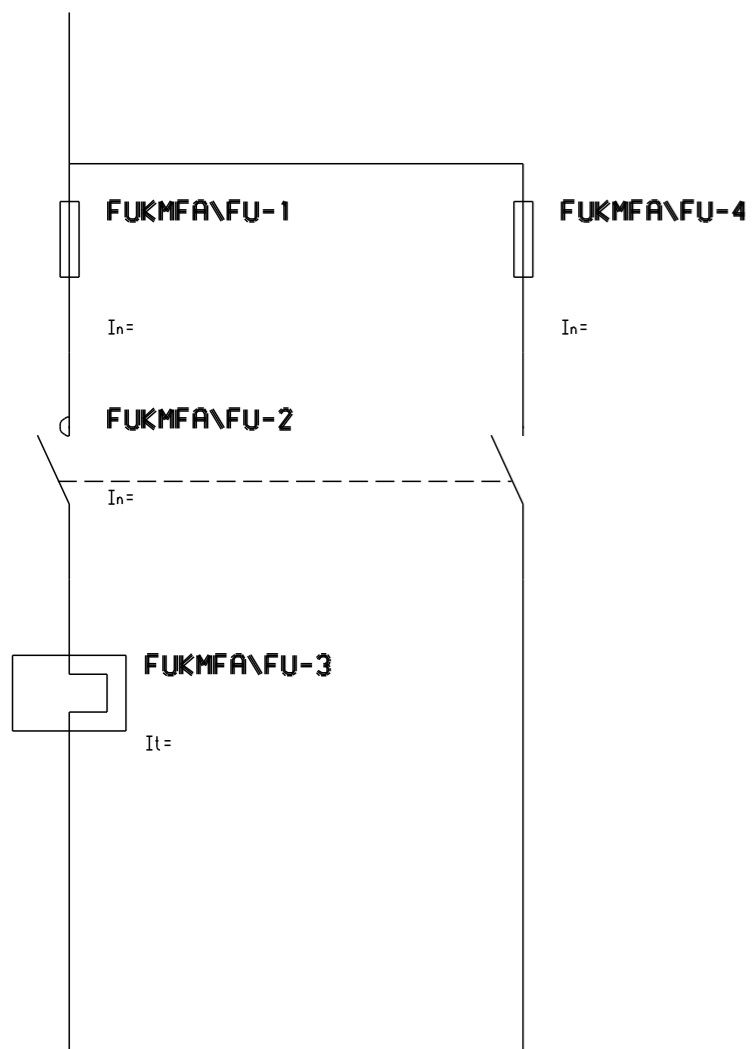

FUKMFA\FU - 2 MODULY

FUOM\OF - 2 MODULY

FUKM

## FUKM



FUKMOM

## FUKMOM

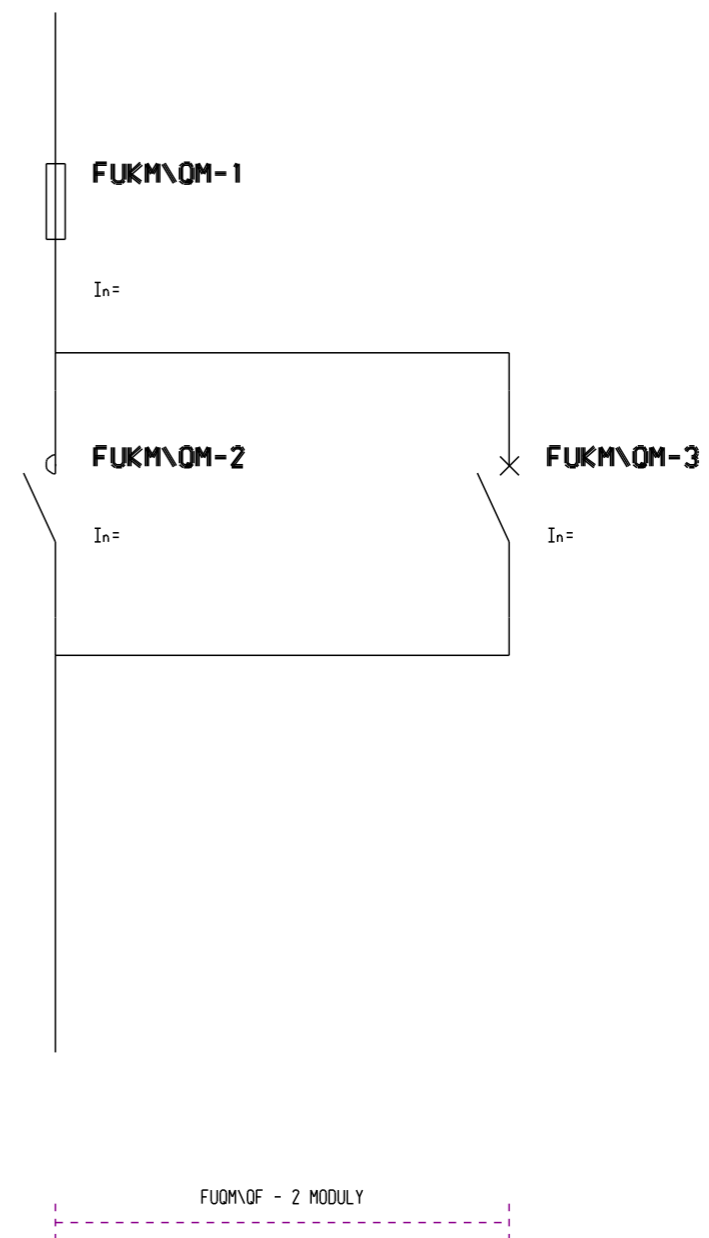

FUKMFANTA\FU

FUQF1FI

FUSA

FUQF1FIZ

FUQMPREP

# FUKMFANTA\FU

# FUQF1FI

# FUSA

# FUQF1FIZ

# FUQMPREP

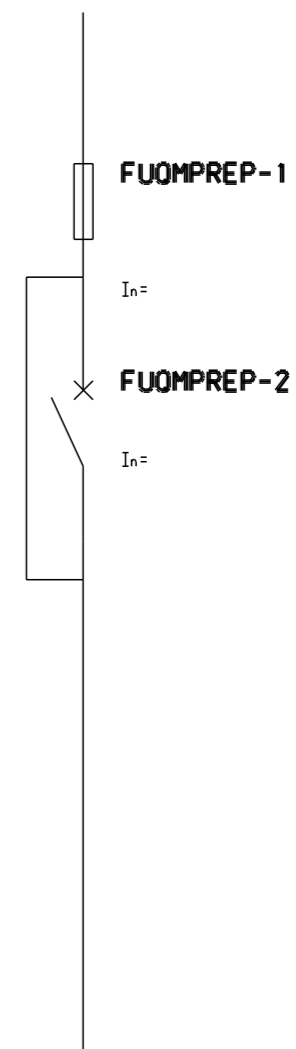
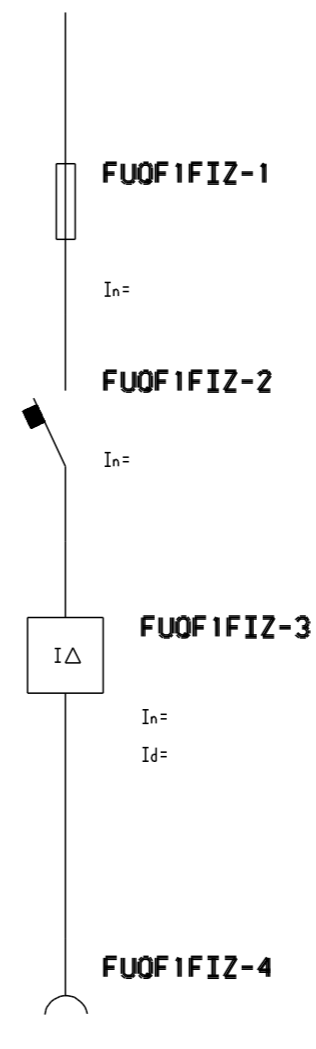
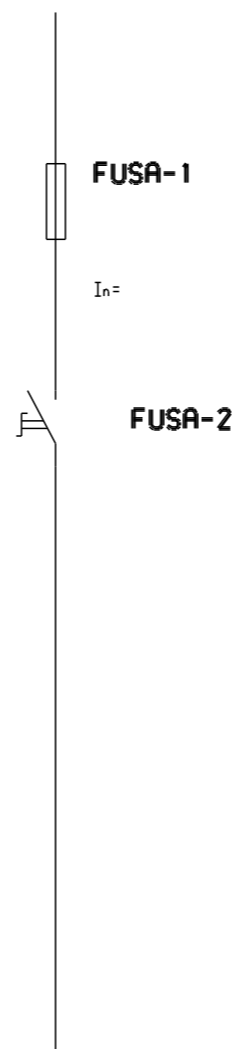
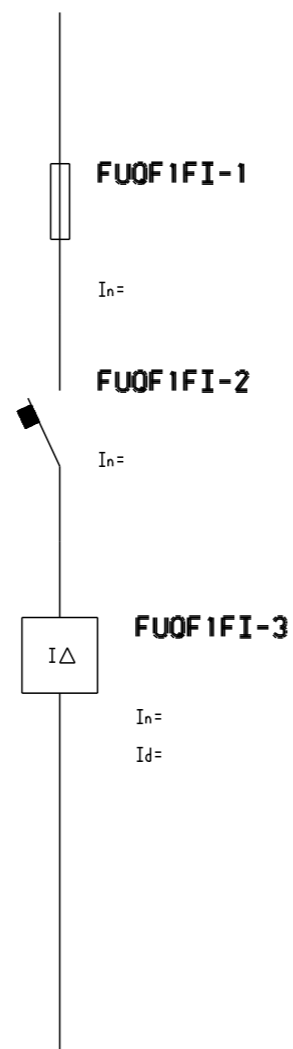
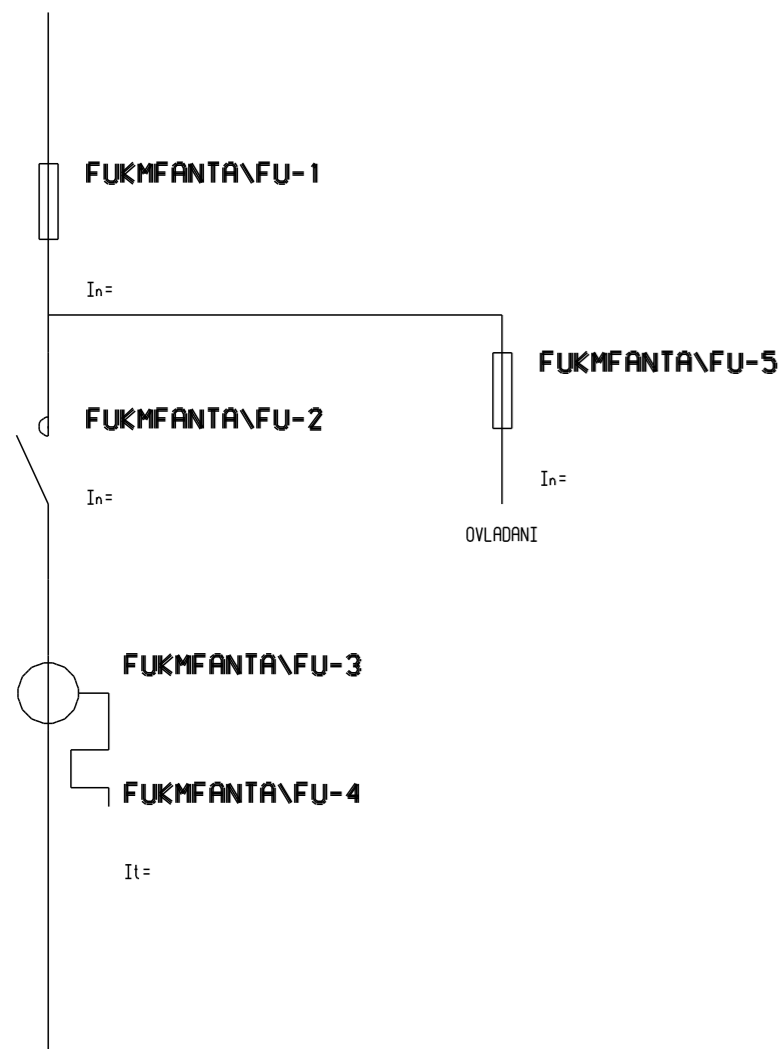

FUKMFANTA\FU - 2 MODULY

PRFU\QFQ\KM

FUFV FV

FUKAQB

PRFUQF

FUKAQBQM

# PRFU\QFQ\KM

# FUFV FV

# FUKAQB

# PRFUQF

# FUKAQBQM

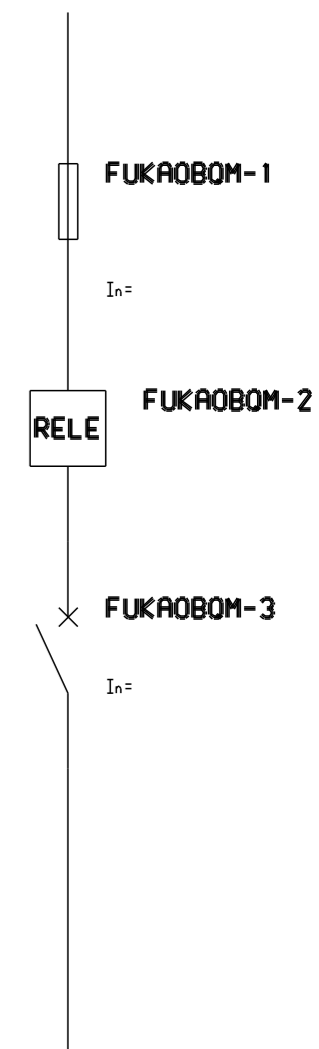
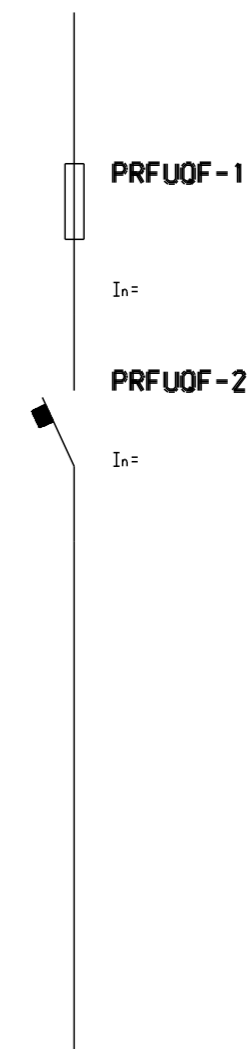
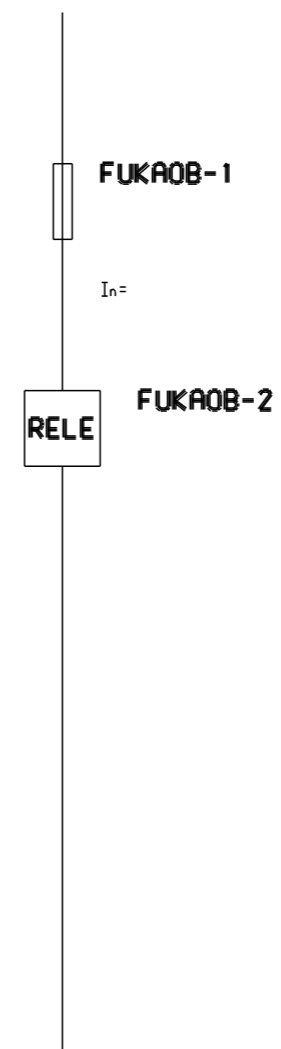
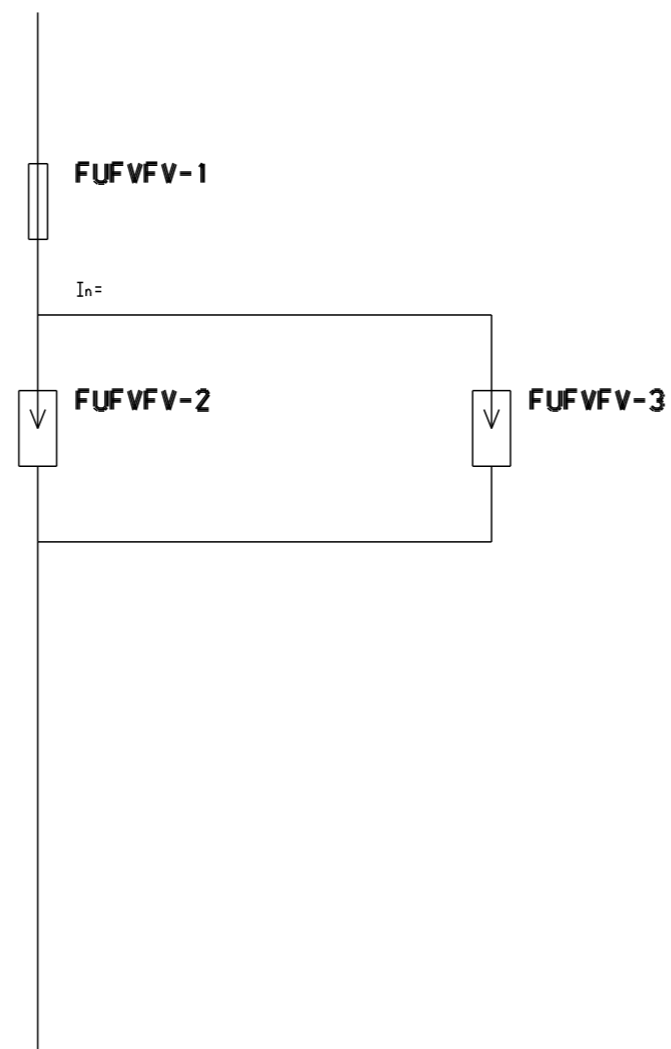
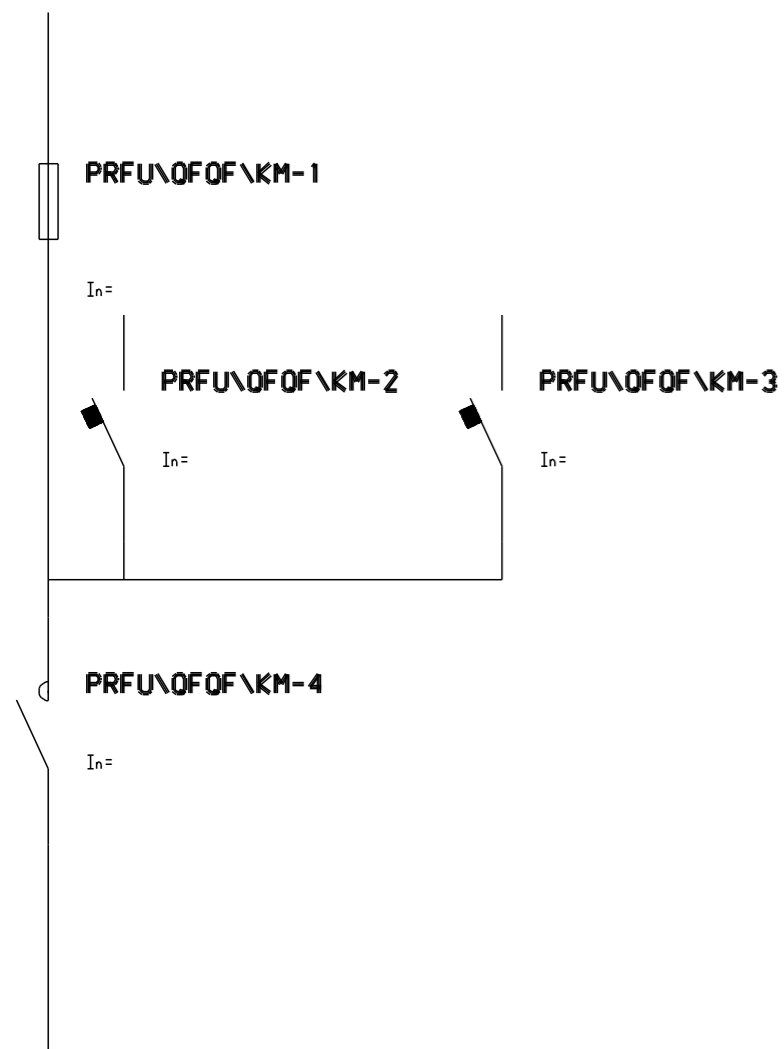

PRFU\QFQ\KM - 2 MODULY

FUFV FV - 2 MODULY

FUKMOF\QF

PRFUKM\FU

PRFUQF\FU

FUOFFIOM

FUFA

FUFUKM

### FUKMOF\QF

### PRFUKM\FU

### PRFUQF\FU

### FUOFFIOM

### FUFA

### FUFUKM

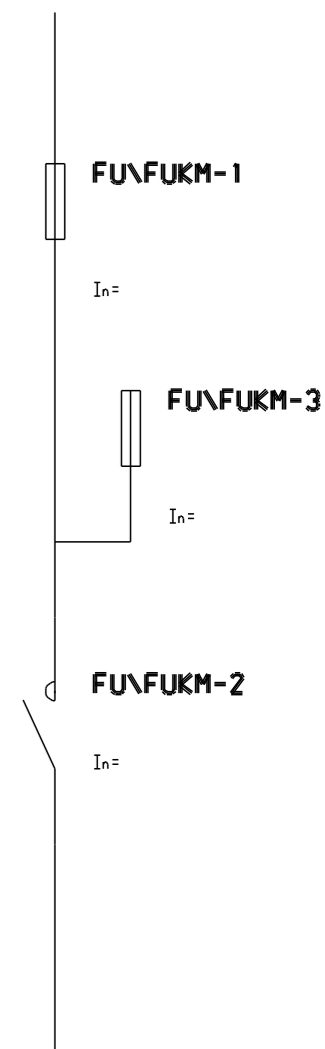
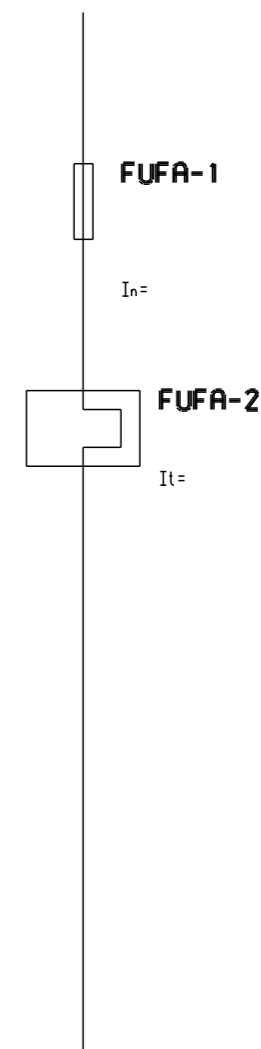
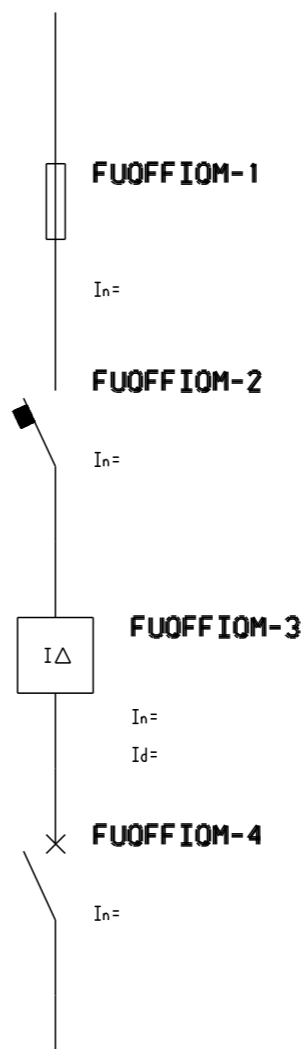
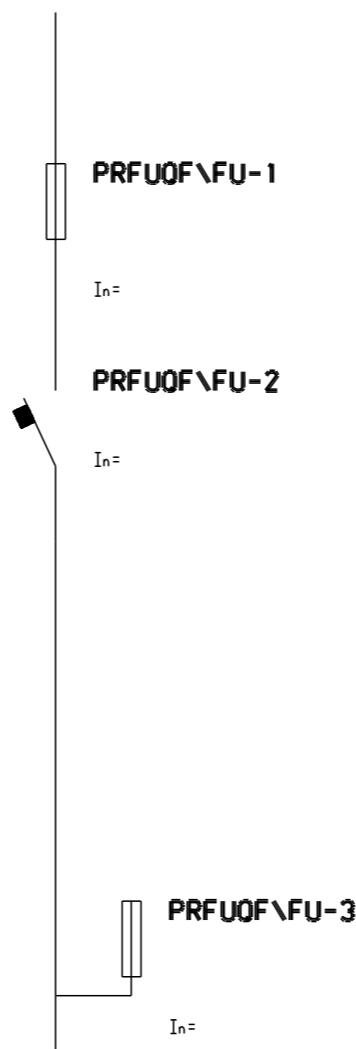
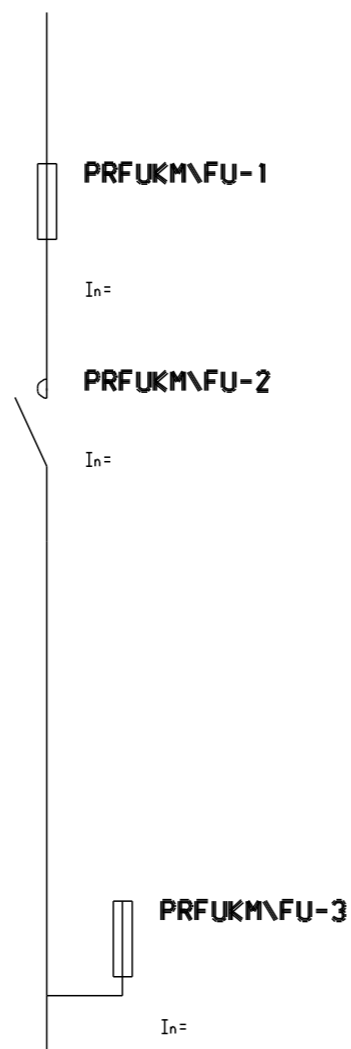
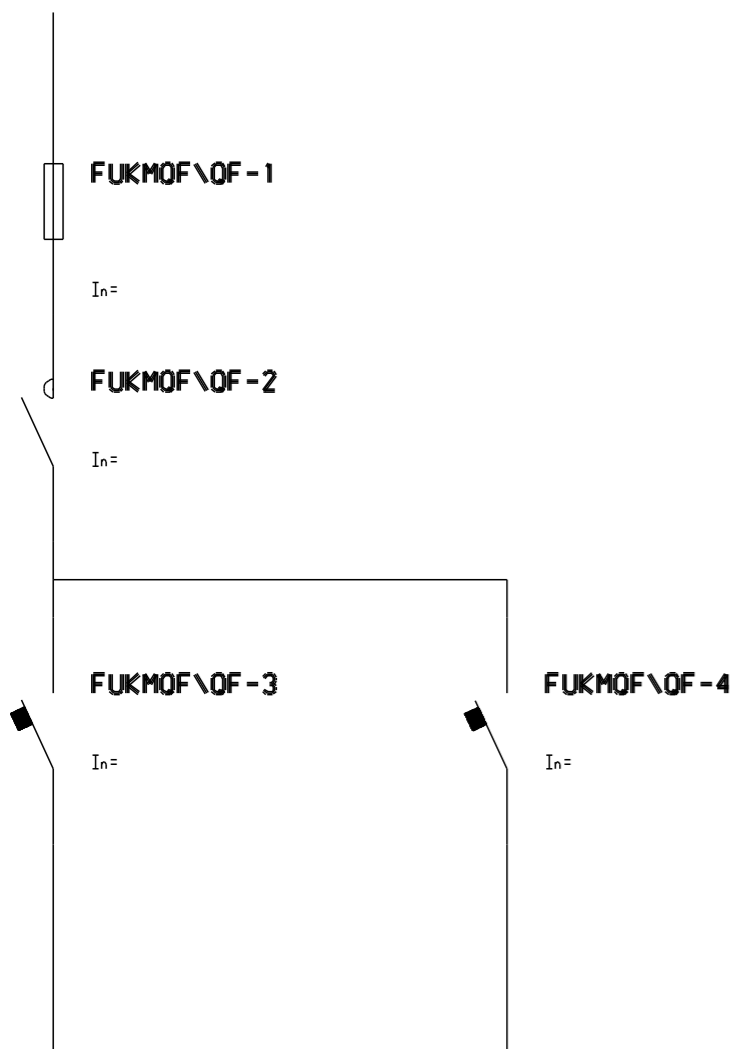

FUKMOF\QF - 2 MODULY

PRFUSKM\FU

FUQM\QFOVL

FUFI

FUKMFA\QF

FUVD

### PRFUSKM\FU

### FUQM\QFOVL

### FUFI

### FUKMFA\QF

### FUVD

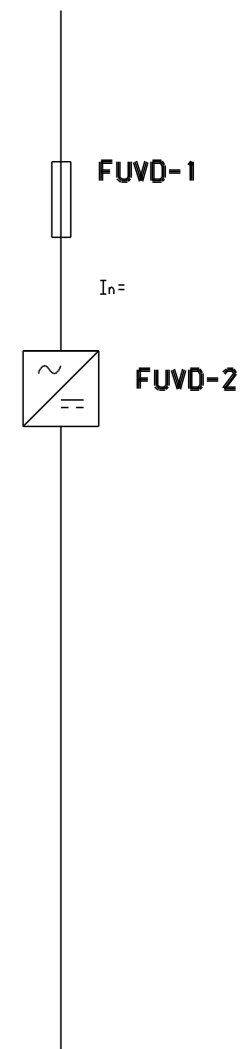
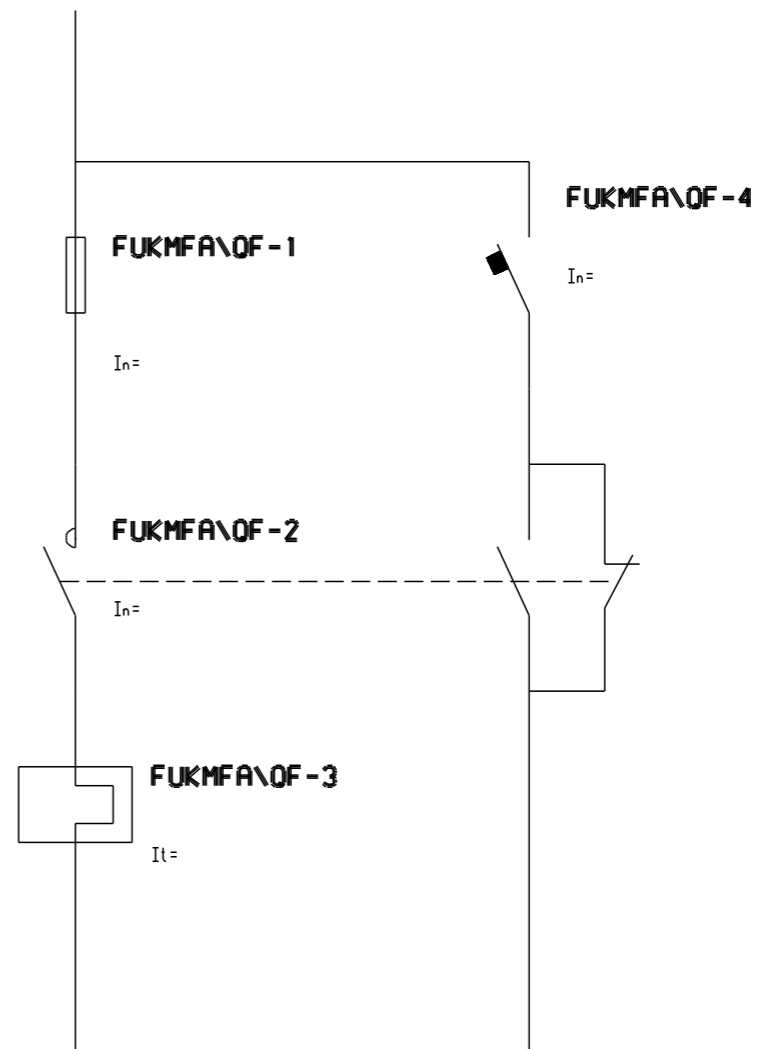
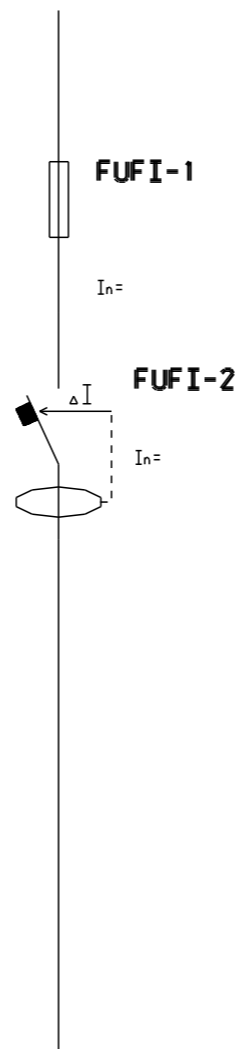
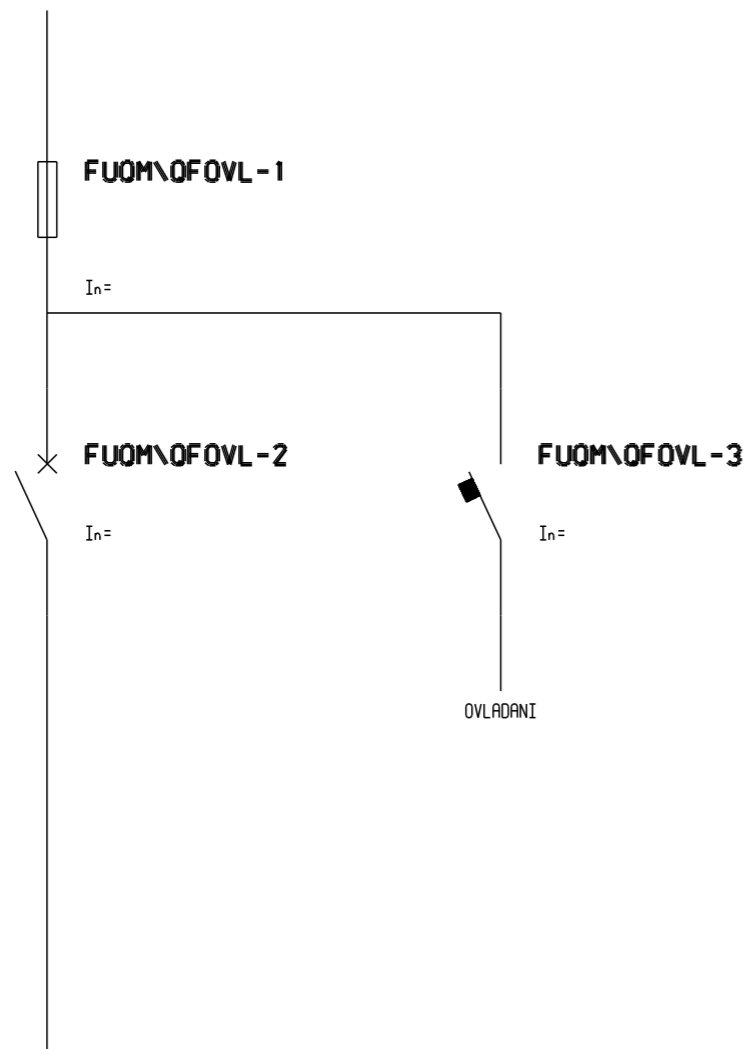
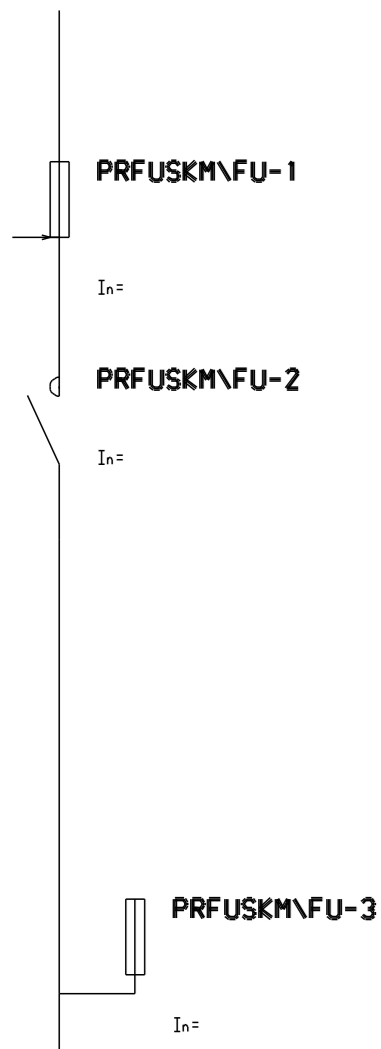

FUQM\QFOVL - 2 MODULY

FUKMFA\QF - 2 MODULY

FUKMFA\FA

FUFUOVLBP

FUKMFAQF

FUQFOMKA

FUQFKA

FUQM\QMOB

# FUKMFA\FA

# FUFUOVLBP

# FUKMFAQF

# FUQFOMKA

# FUQFKA

# FUQM\QMOB

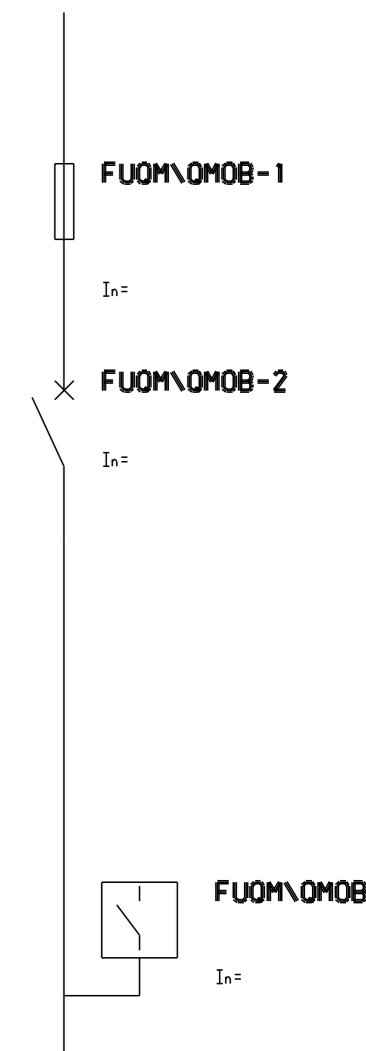
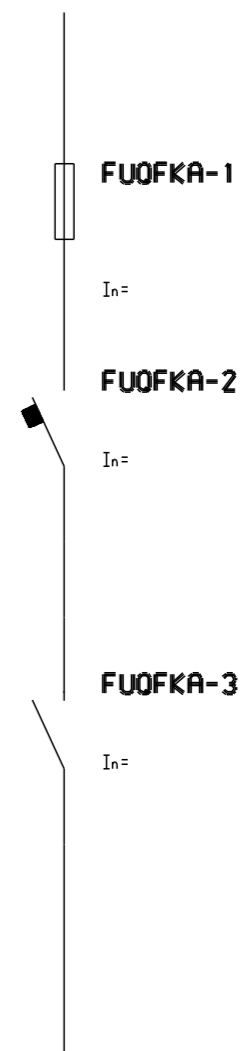
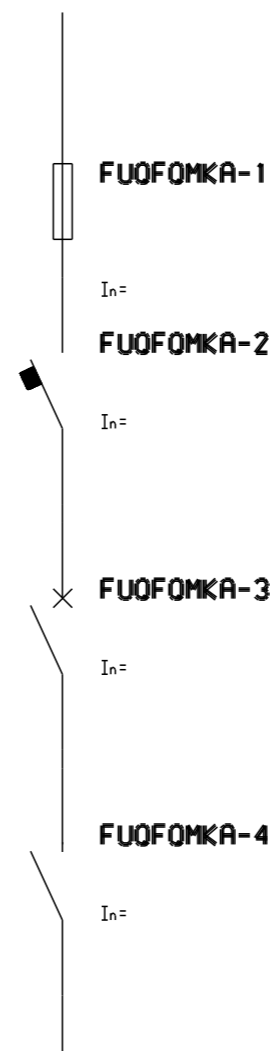
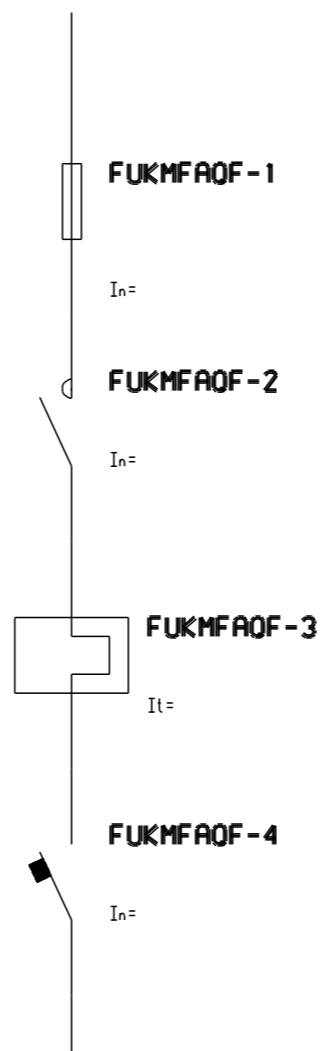
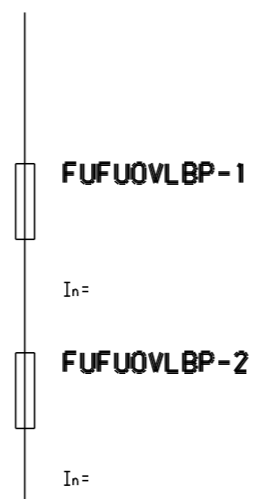
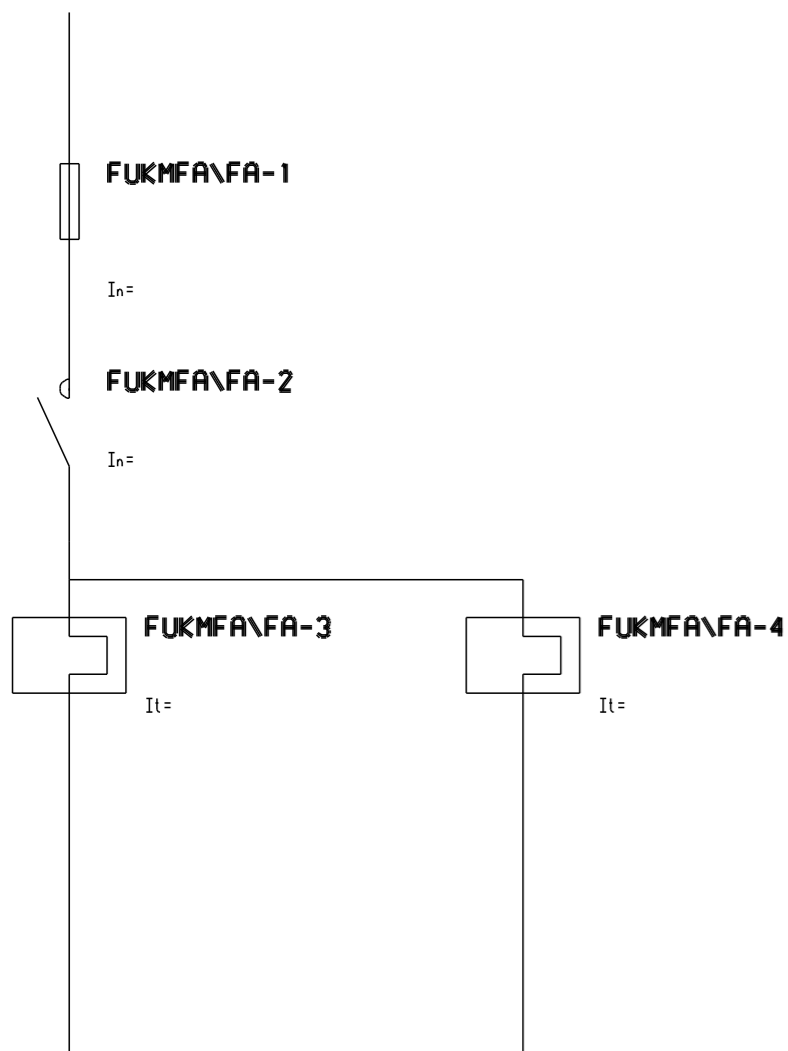

FUKMFA\FA - 2 MODULY



FUNGFA

FUFAKM2

FUTFUZ

FUNG

FUX

FUOFFI

PRFUS<QM>RA\FUSOF

### FUNGFA

### FUFAKM2

### FUTFUZ

### FUNG

### FUX

### FUOFFI

### PRFUS<QM>RA\FUSOF

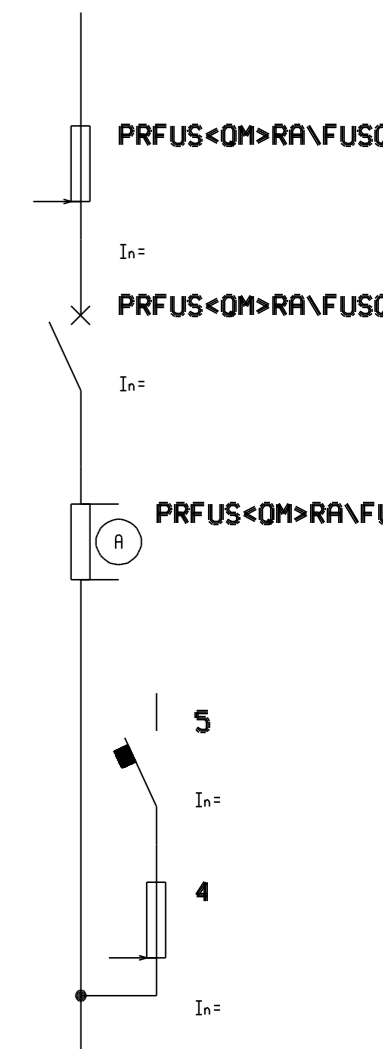
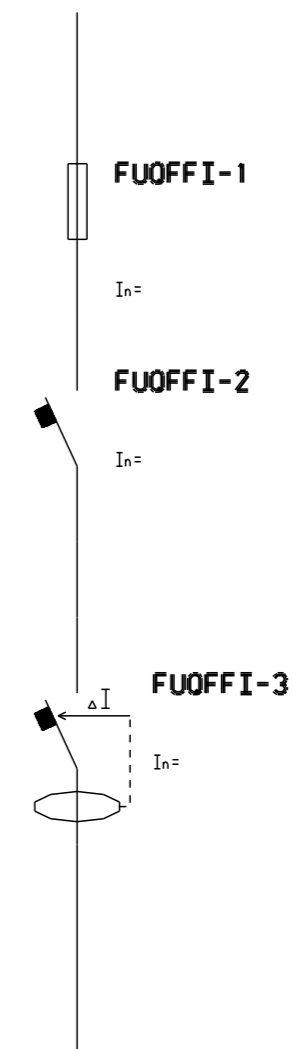
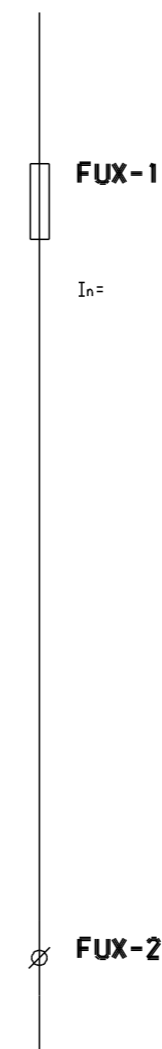
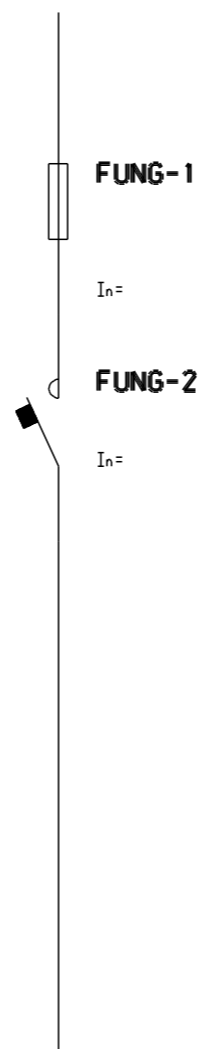
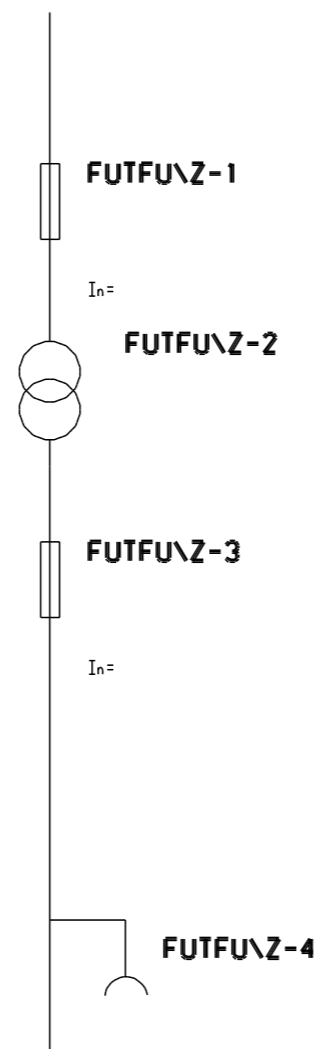
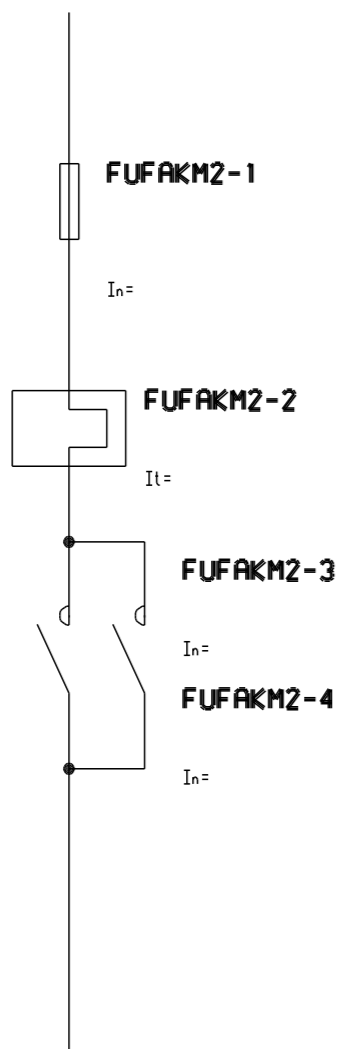
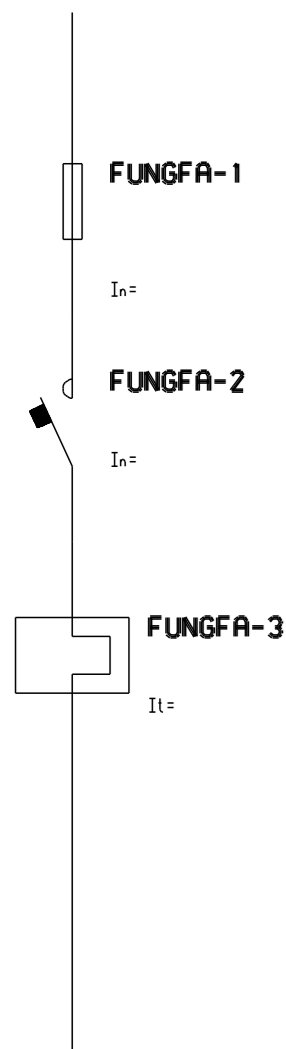

FUSQFKMX

FUFAKM

FUQF\QF

FUFAKM\FA

FUKMFAX

### FUSQFKMX

### FUFAKM

### FUQF\QF

### FUFAKM\FA

### FUKMFAX

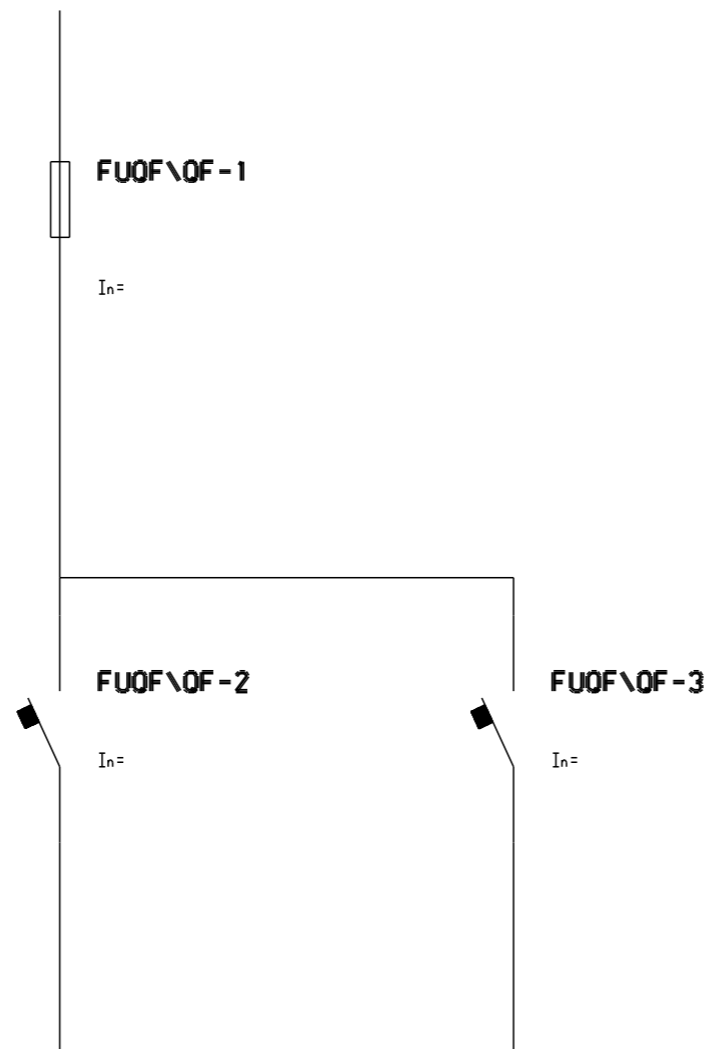
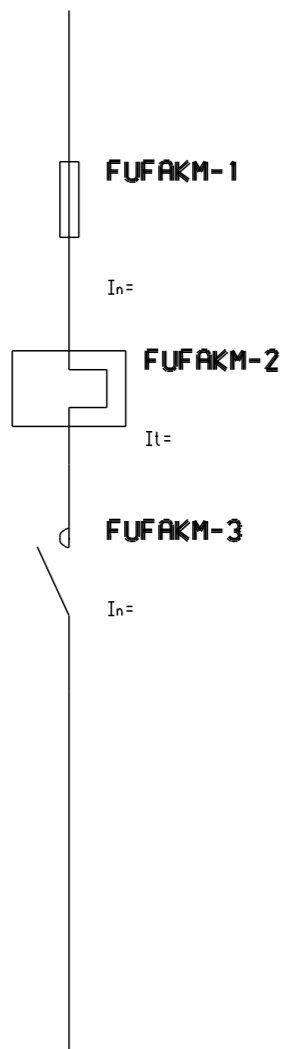
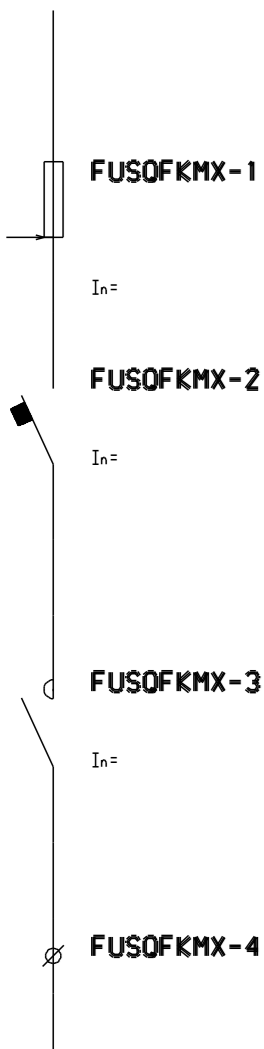

FUKMFAFA - 2 MODULY

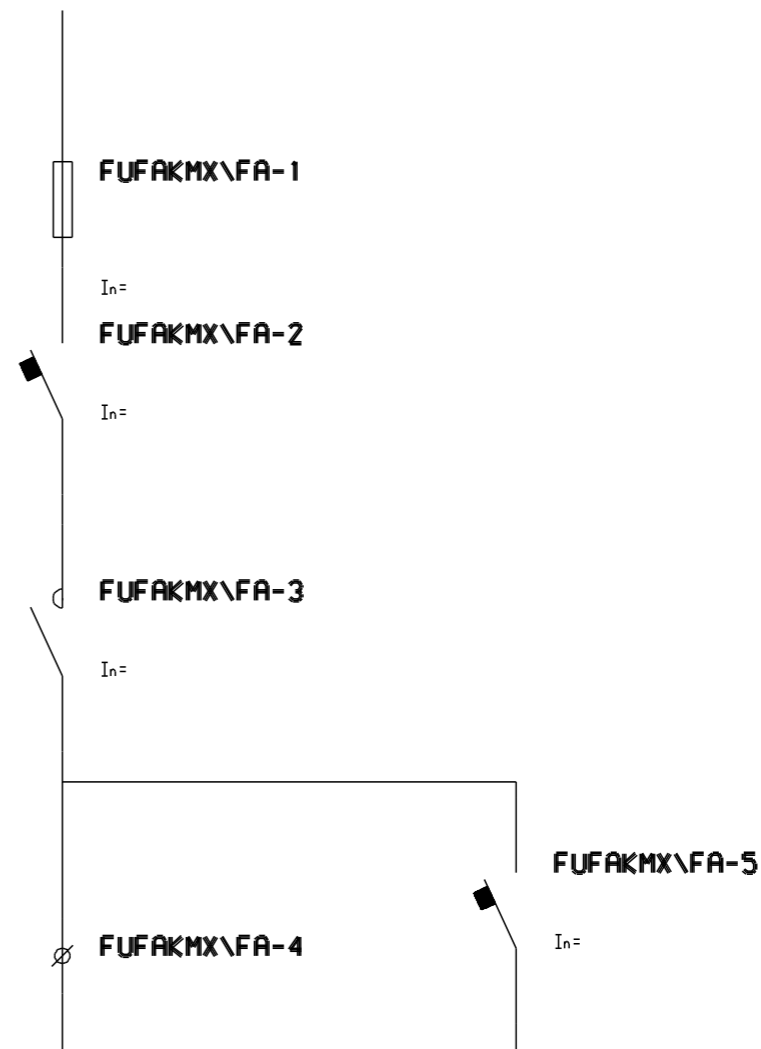

FUKMFAFA - 2 MODULY

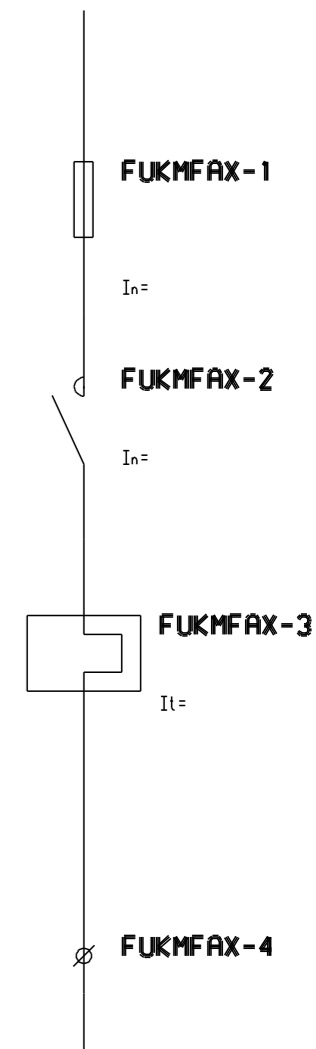

FUTFU\FU

# FUTFU\FU

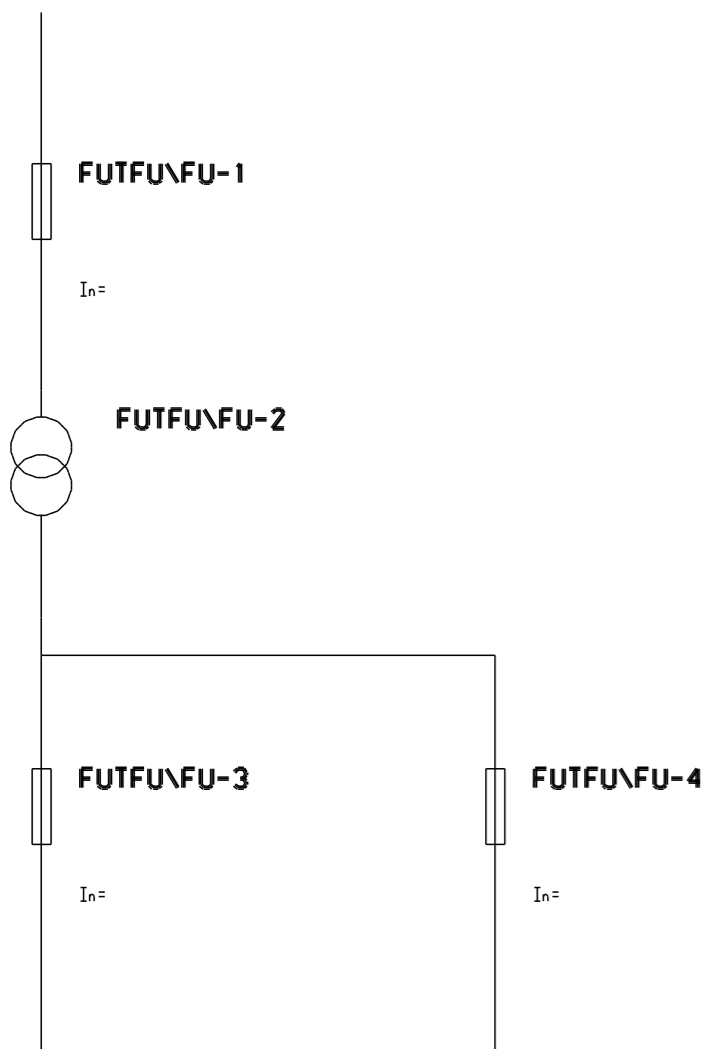

FUTFU\FU - 2 MODULY

FUKM\OF

# FUKM\OF

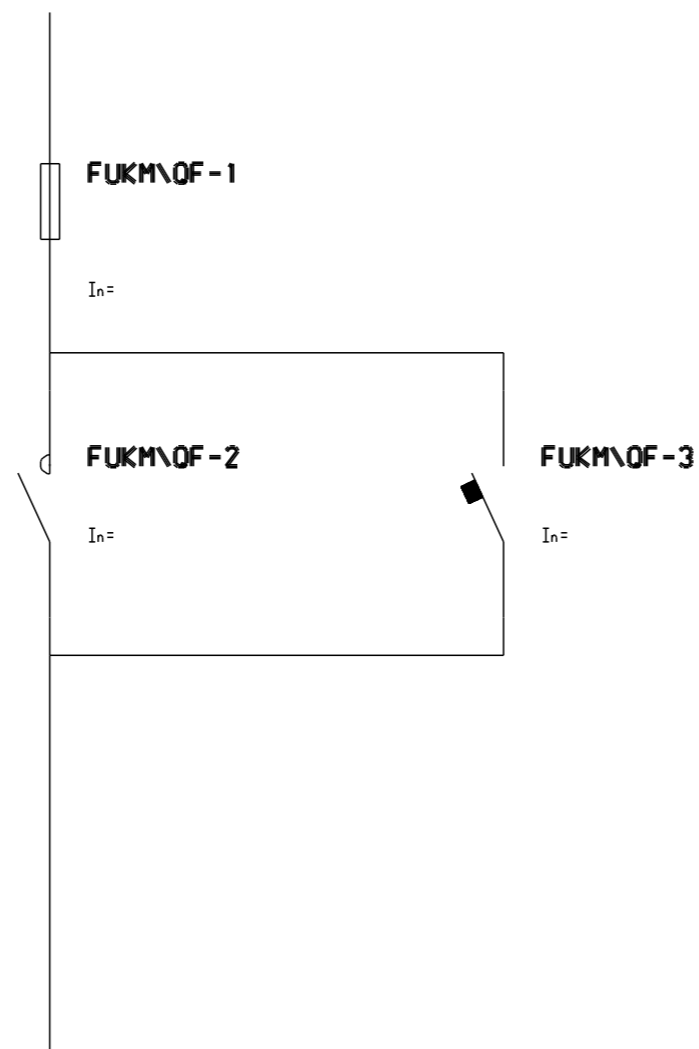

FUKM\OF - 2 MODULY

FUQFX

# FUQFX

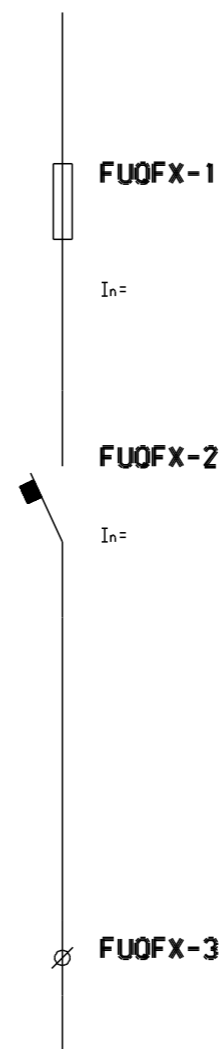

FUQFOVL

# FUQFOVL

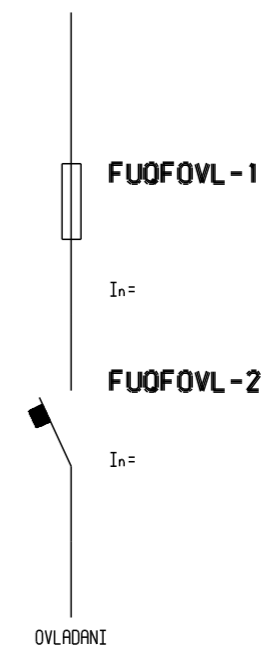

FUSQF\QF

# FUSQF\QF

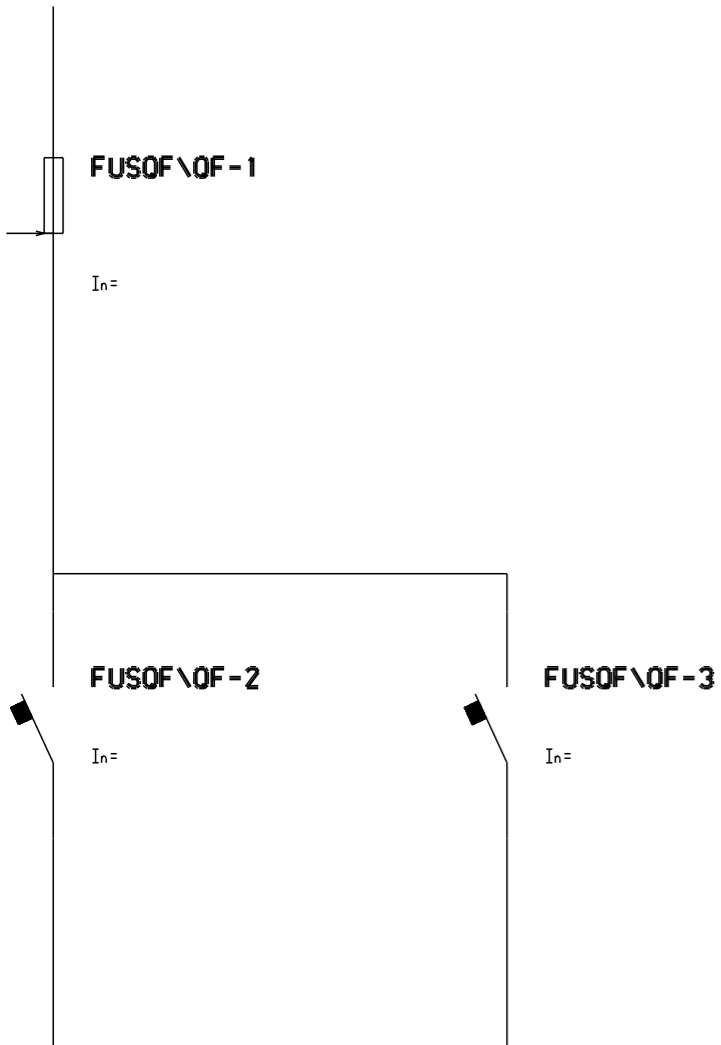

FU4QM4NOTREP4

# FU4QM4NOTREP4

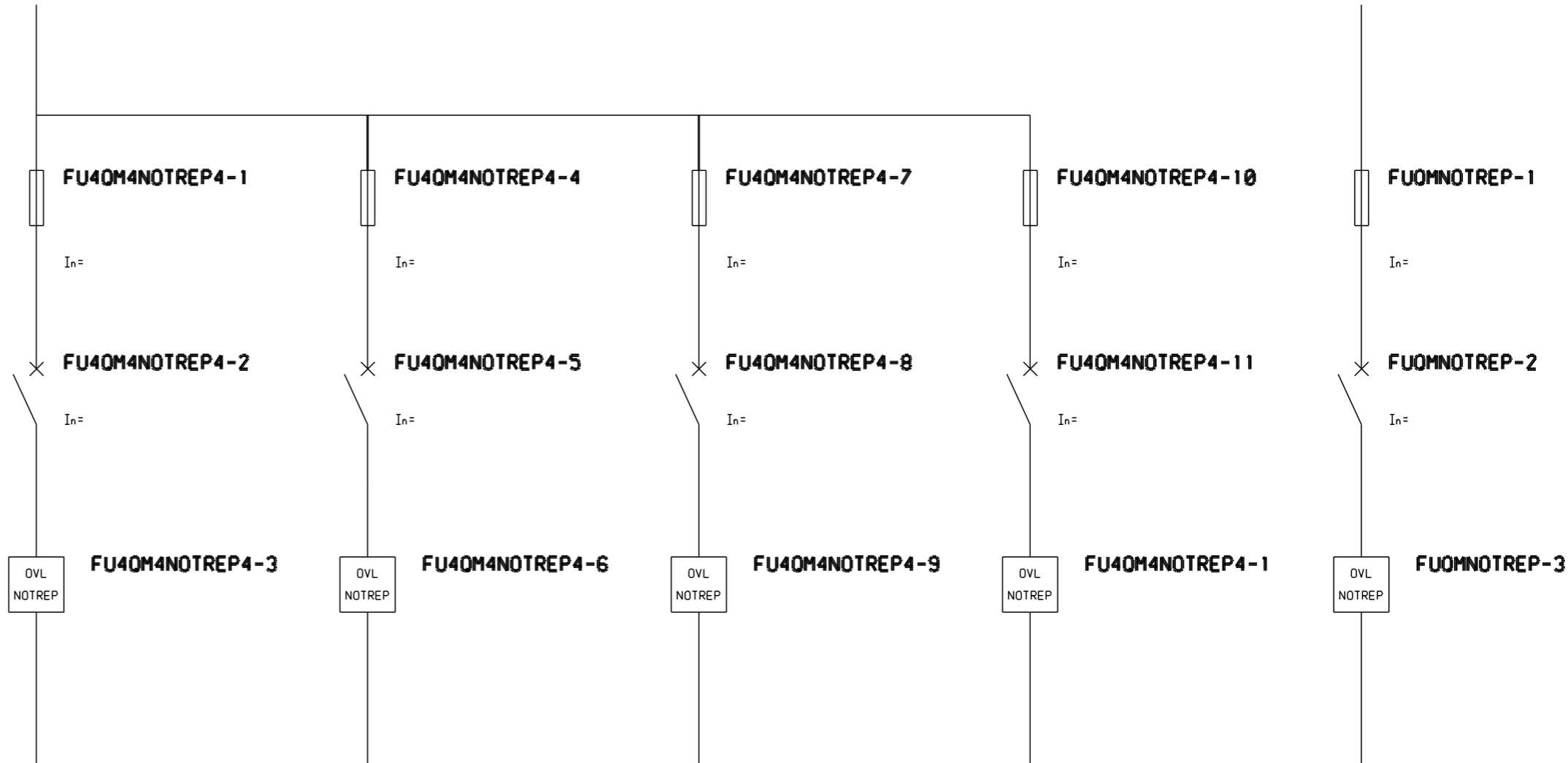

FUQMNOTREP

# FUQMNOTREP

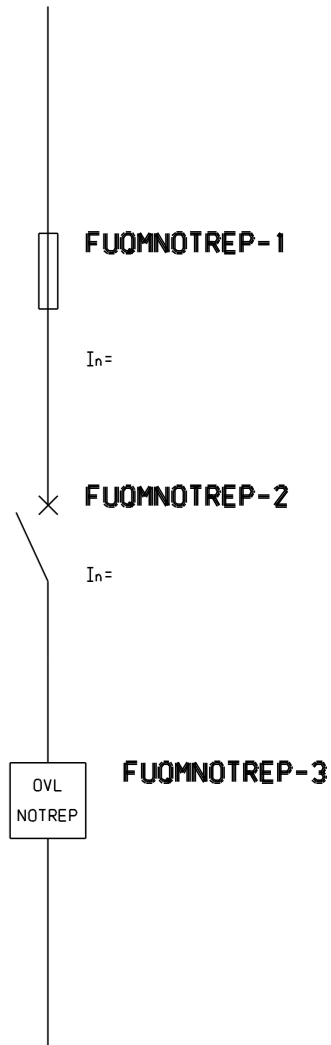

FU4QM4NOTREP4 - 4 MODULY

FUOFKMX\QFX

# FUOFKMX\QFX

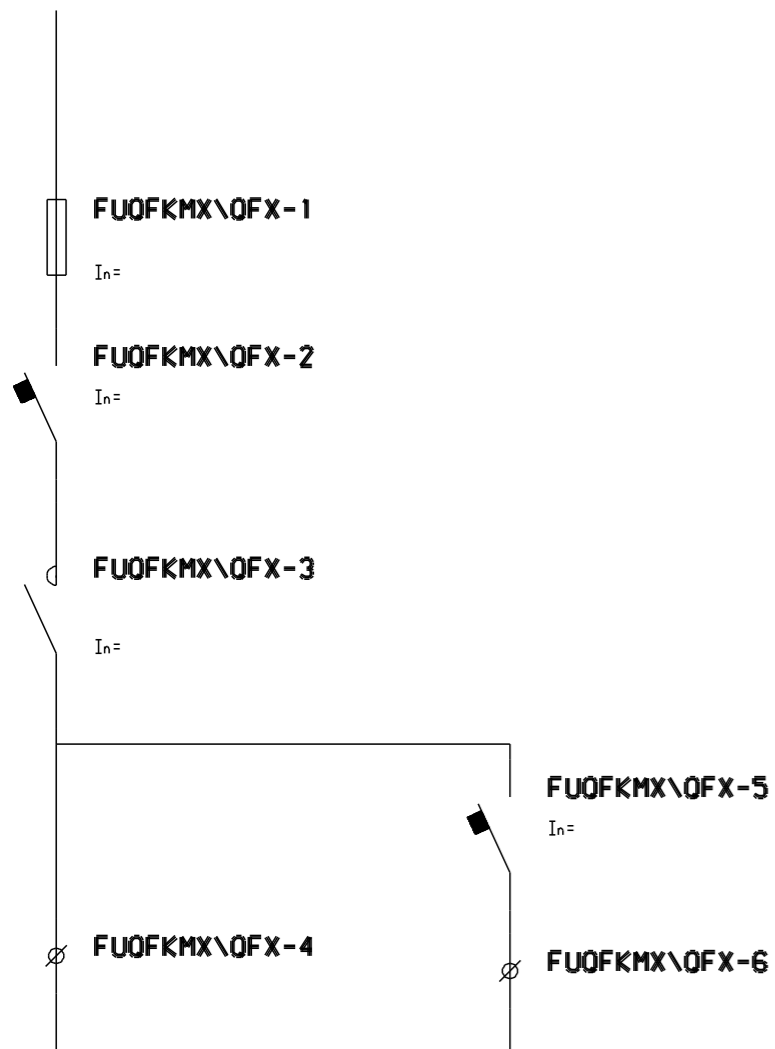

FUOFKMX\QFX - 2 MODULY

PRTAQF\OSF\OSF\OSF

# PRTAQF\OSF\OSF\OSF

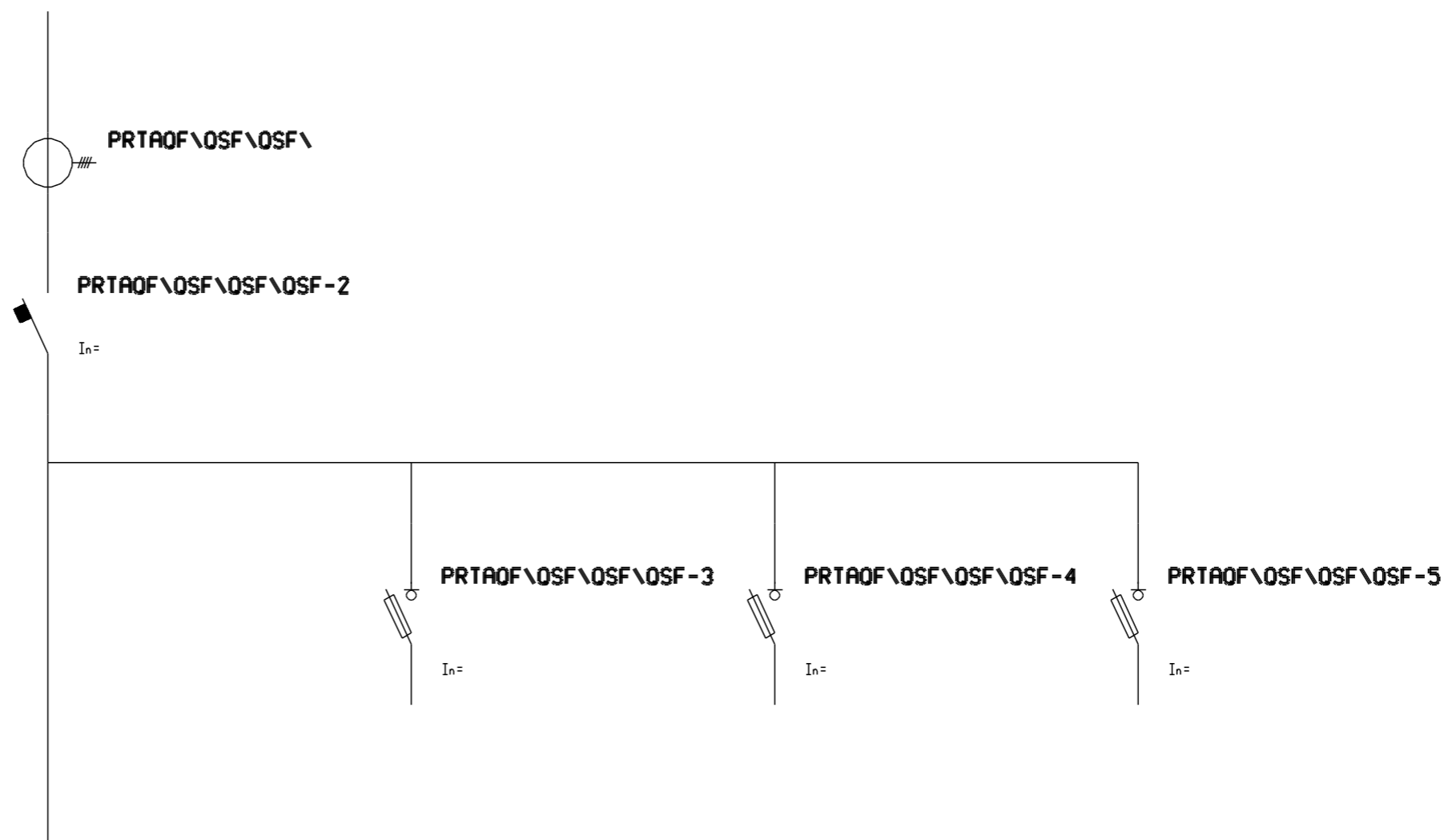

PRTAQF\OSF\OSF\OSF - 4 MODULY

FUW2

### FUW2

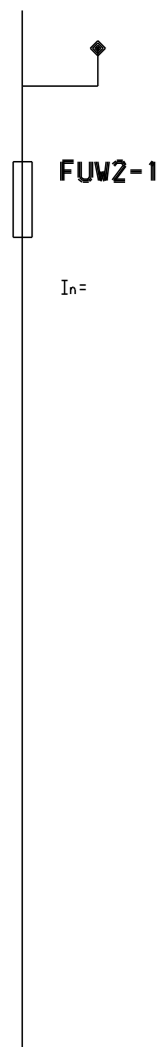

FUXW2

### FUXW2



FUWH

### FUWH

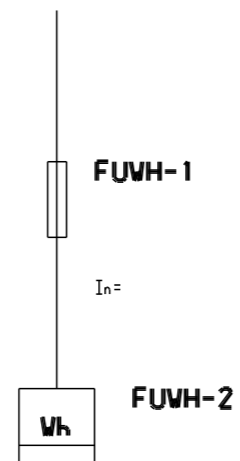

FUFVPEN

### FUFVPEN

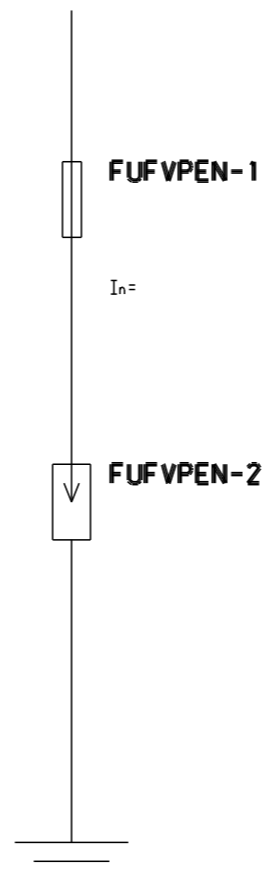

FUOVL1

### FUOVL1

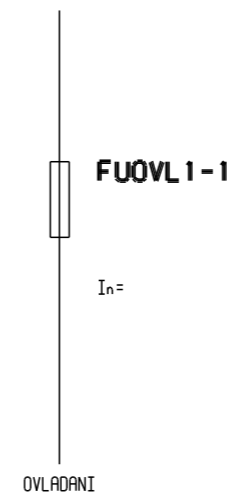

FUKMX

### FUKMX

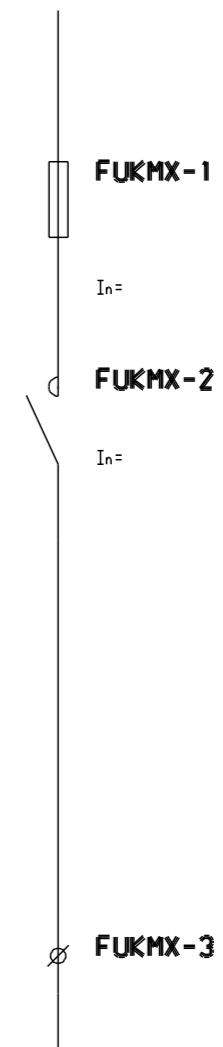

FUOM\KM

# FUOM\KM

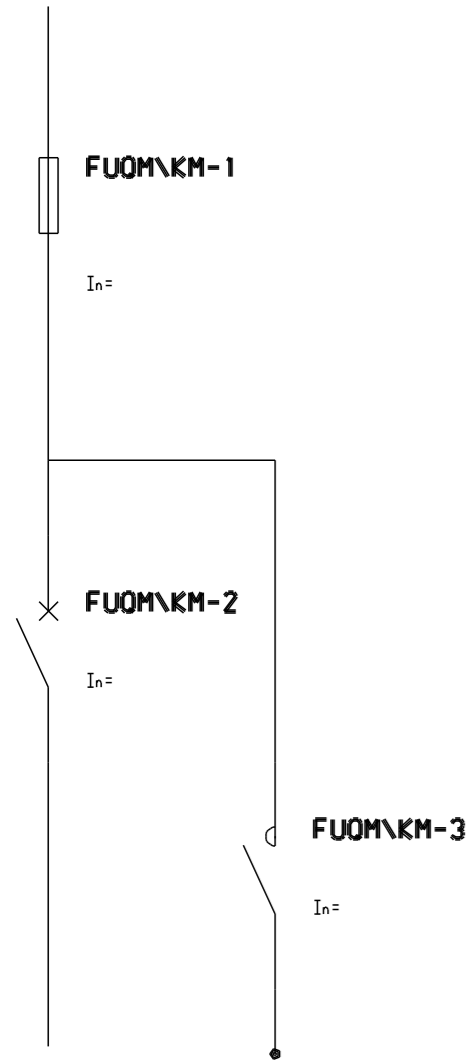

FUOM\KM - 2 MODULY

PRFUTAK\FU2

# PRFUTAK\FU2

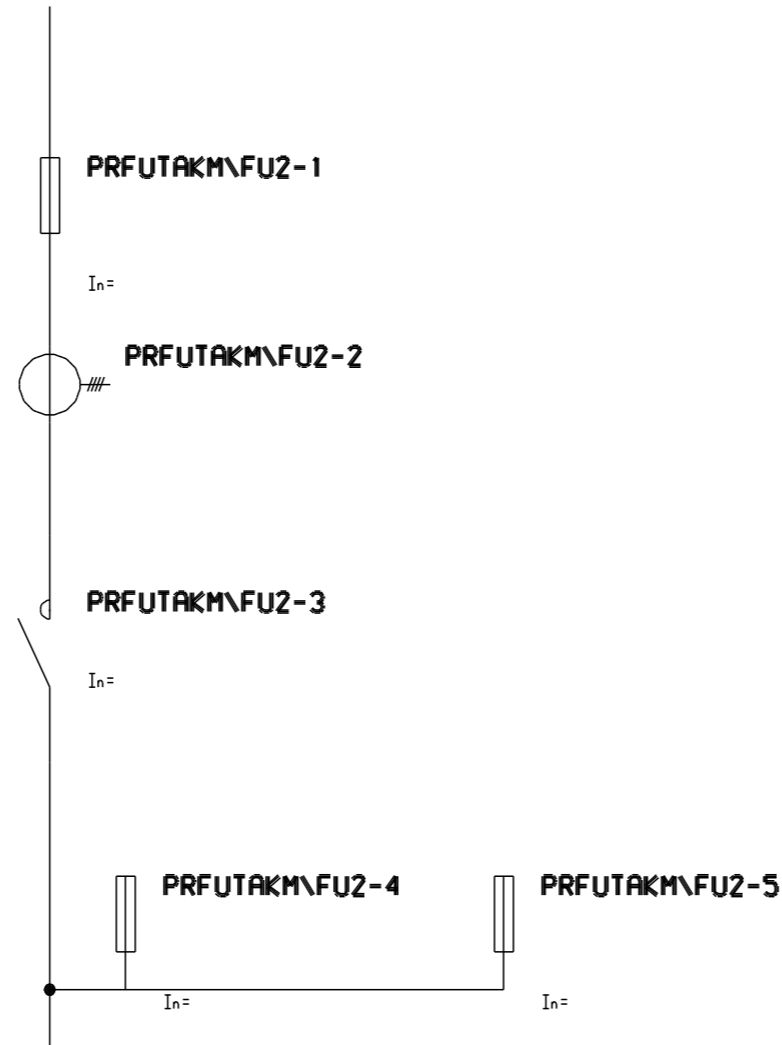

PRFUTAK\FU2 - 2 MODULY

FUKMX\FUOVL

# FUKMX\FUOVL

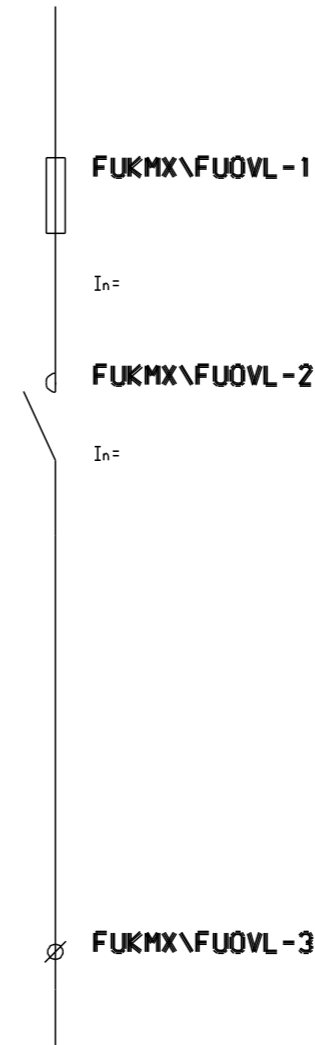

FUKMX\FUOVL - 3 MODULY

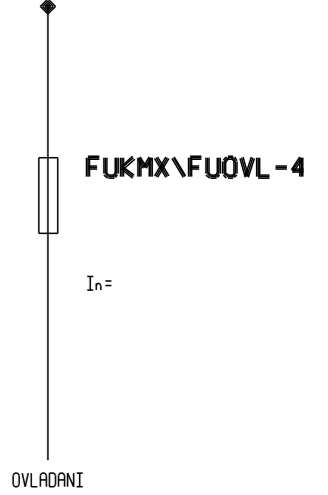

FUKMFAX\FUOVL

FUKM\FUOVL

FUKMFA1

PRFUOMXW2

### FUKMFAX\FUOVL

### FUKM\FUOVL

### FUKMFA1

### PRFUOMXW2

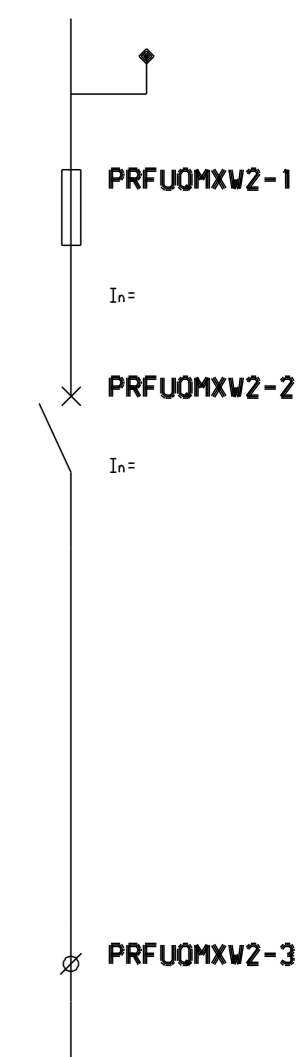
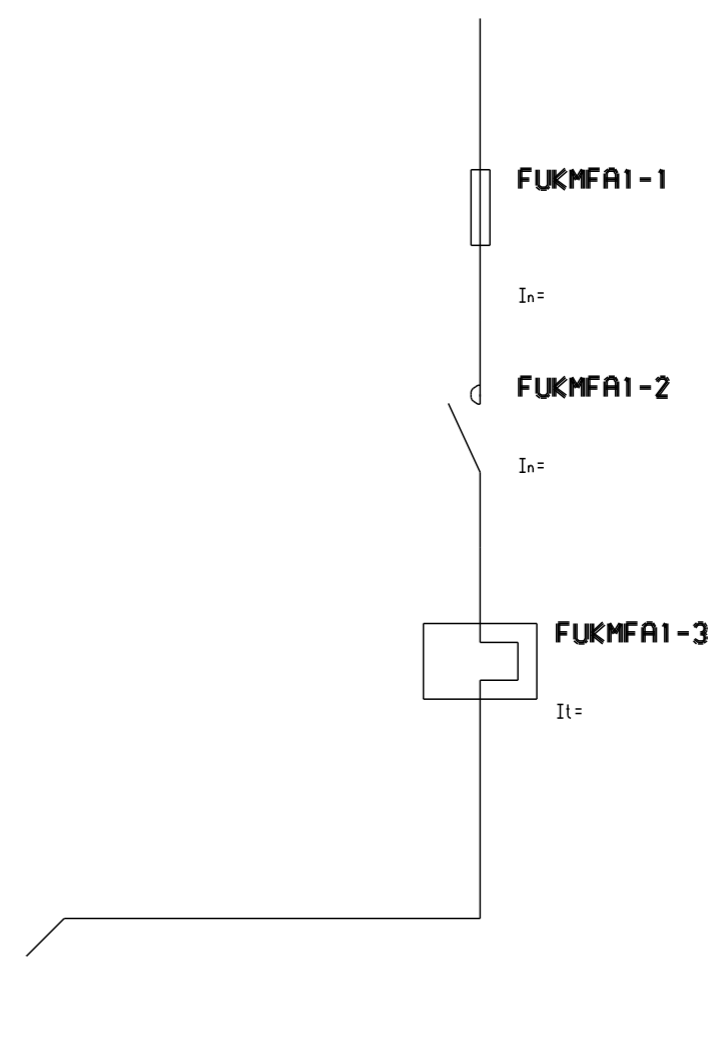
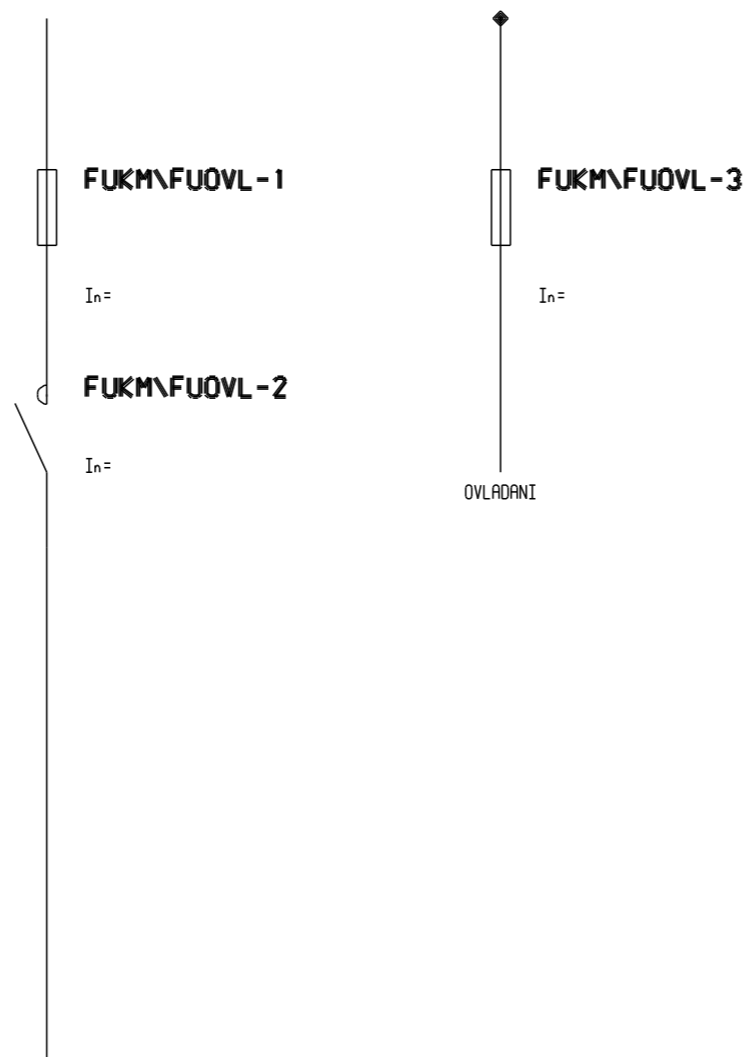
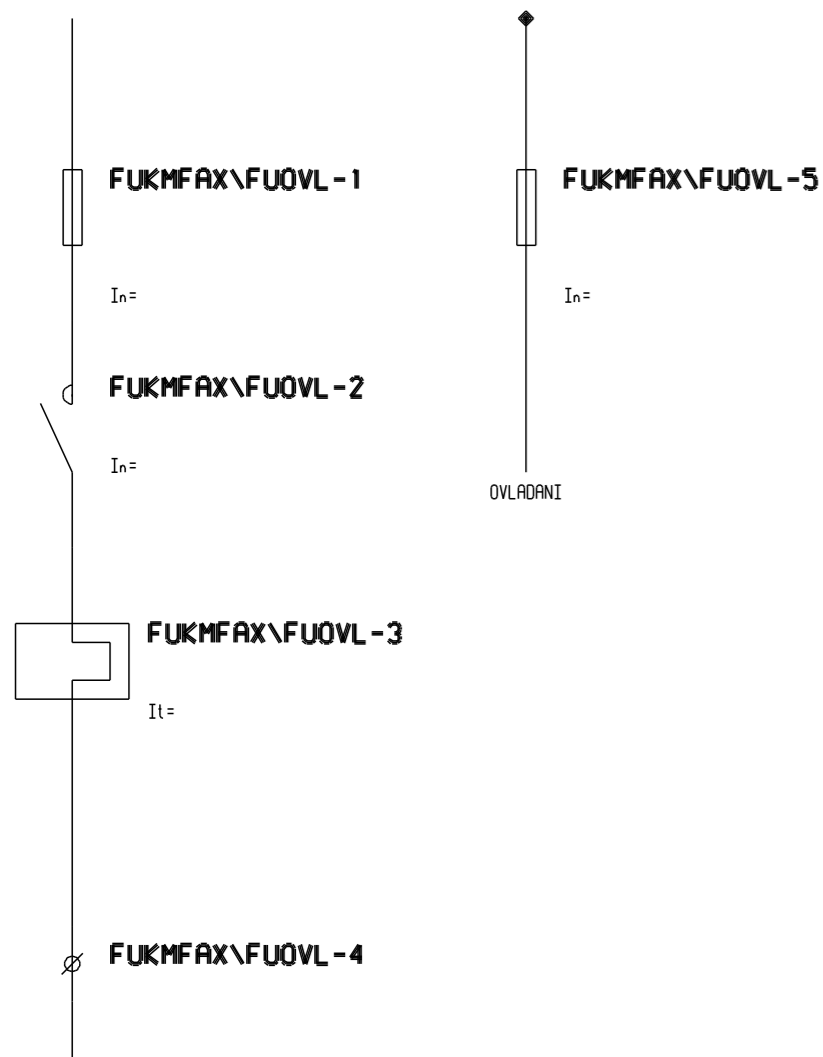

FUKMFAX\FUOVL - 2 MODULY

FUKM\FUOVL - 2 MODULY

FUKMFA1 - 1 MODUL



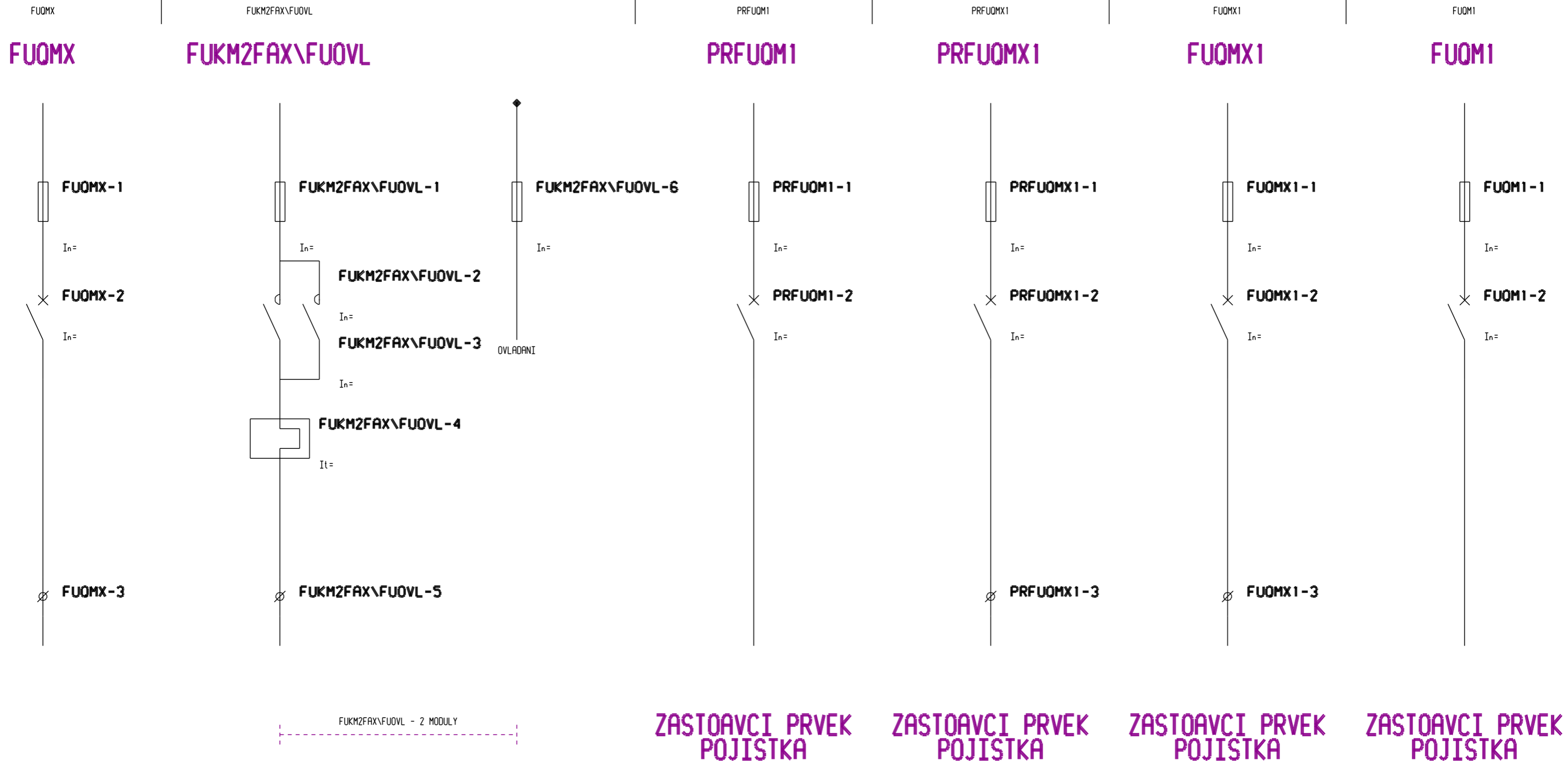

FUKMX\FUOVL1

OSFOPKM2X\X

FUXXW2

PRFUOF\QFOFOVL

# FUKMX\FUOVL1

# OSFOPKM2X\X

# FUXXW2

# PRFUOF\QFOFOVL

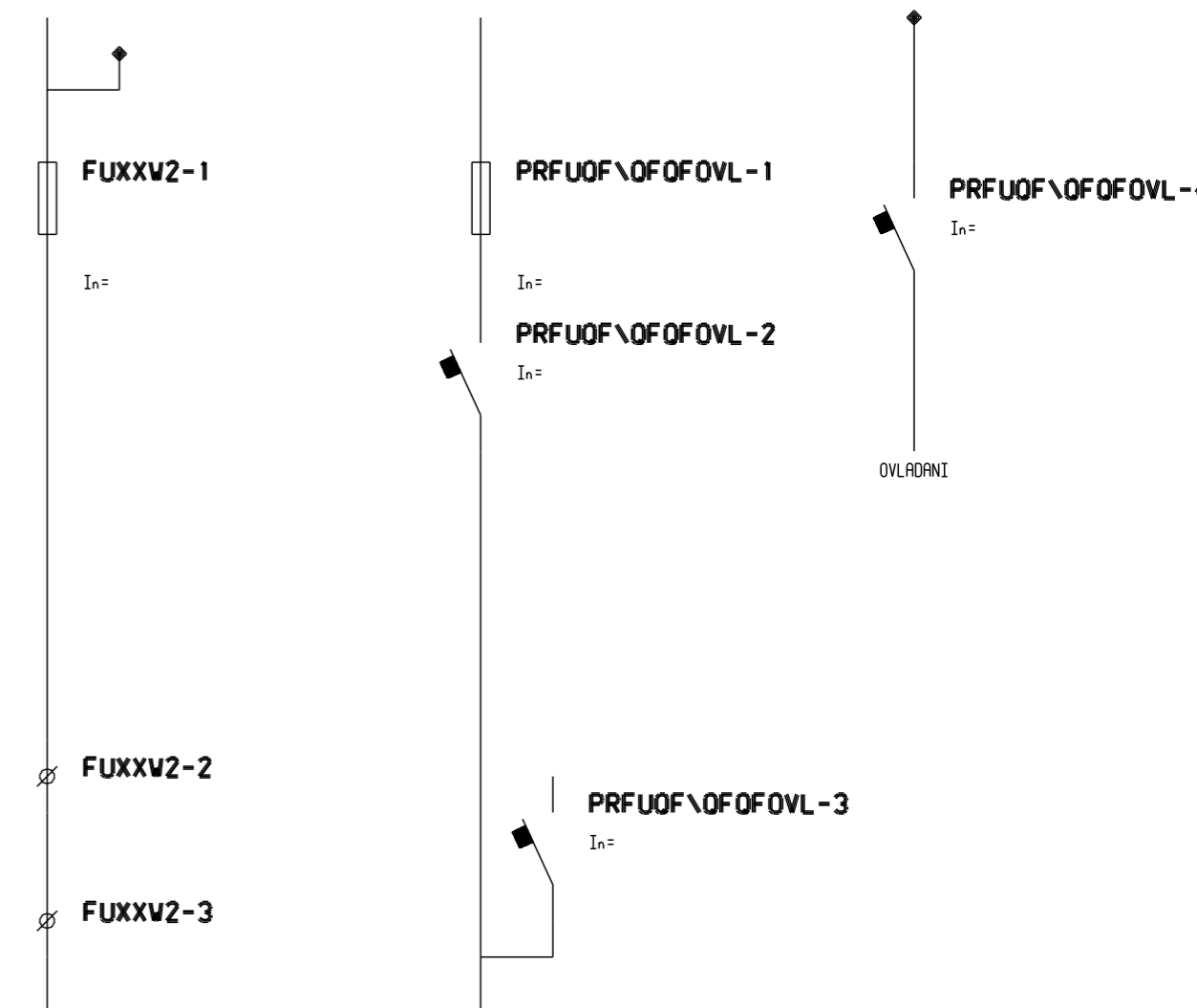
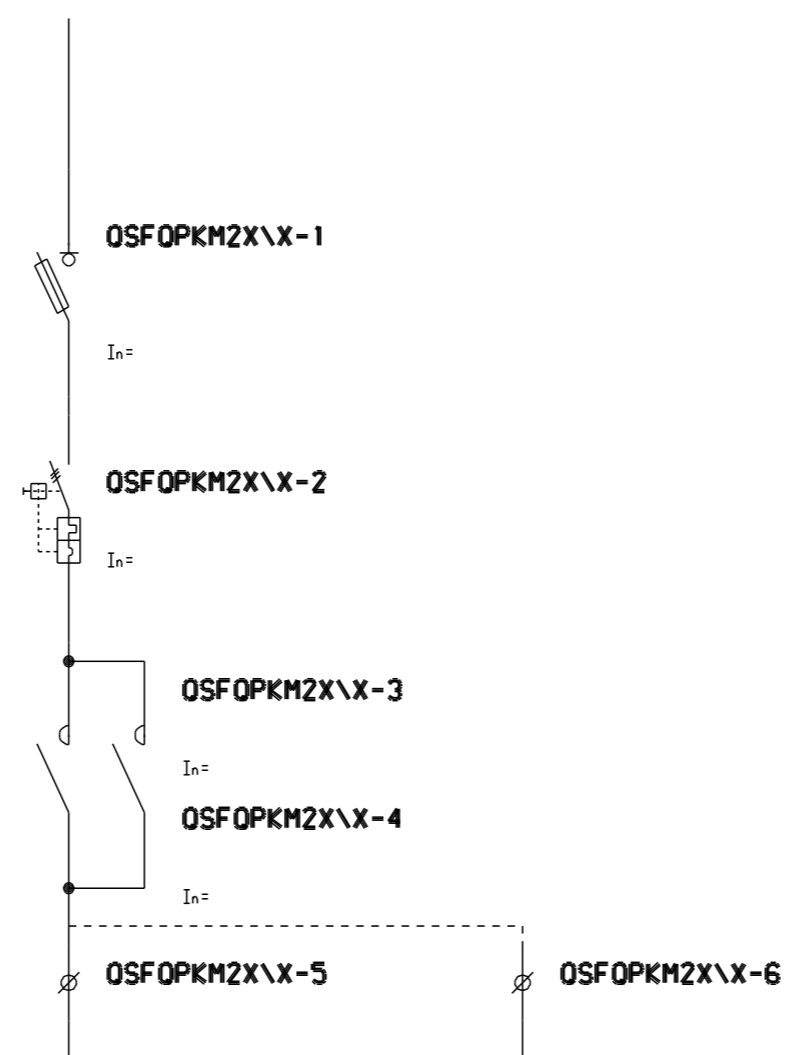
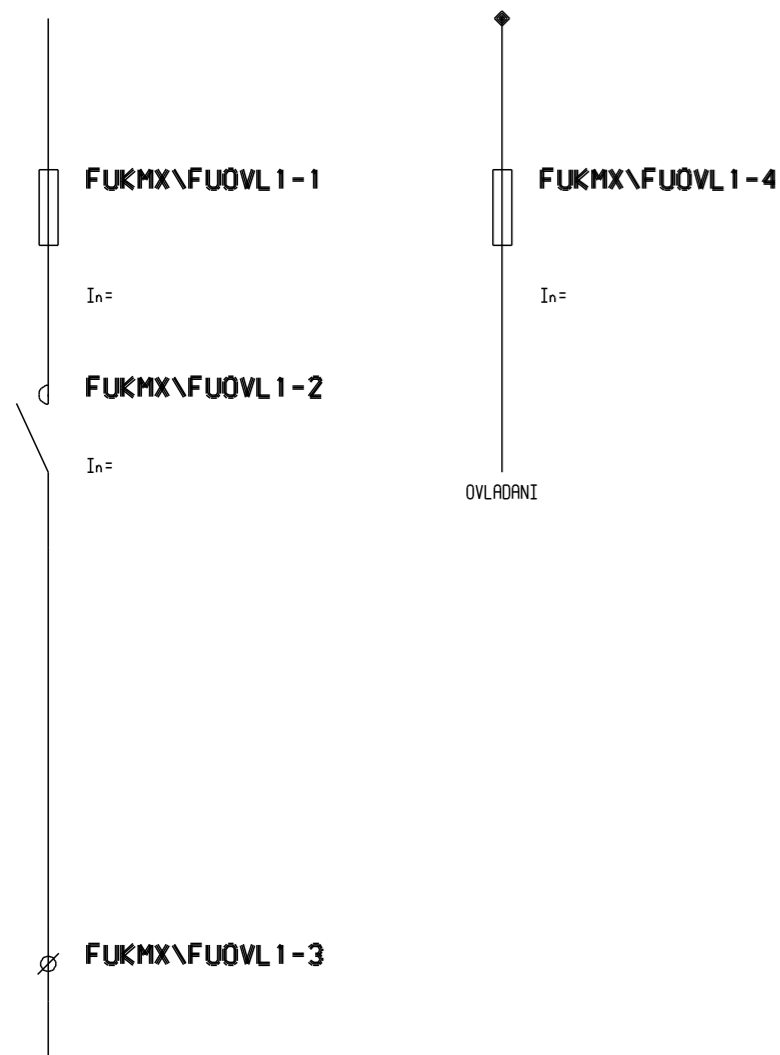

FUKMX\FUOVL1 - 2 MODULY

OSFOPKM2X\X - 2 MODULY

FUOF\QFOFOVL - 2 MODULY

FUKM2FAX\QFOVL2

FUKMX3\FUOVL

# FUKM2FAX\QFOVL2

# FUKMX3\FUOVL

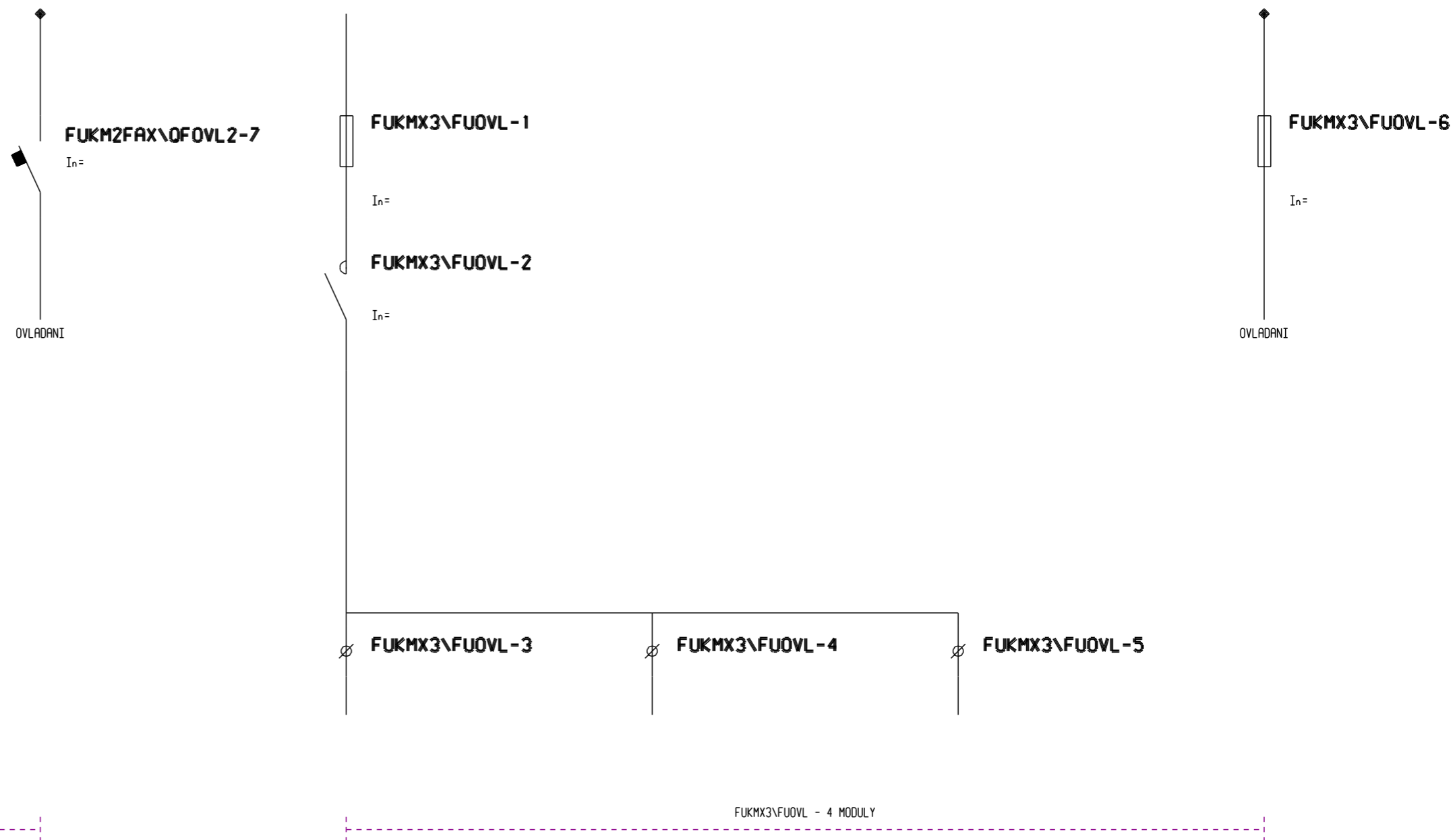
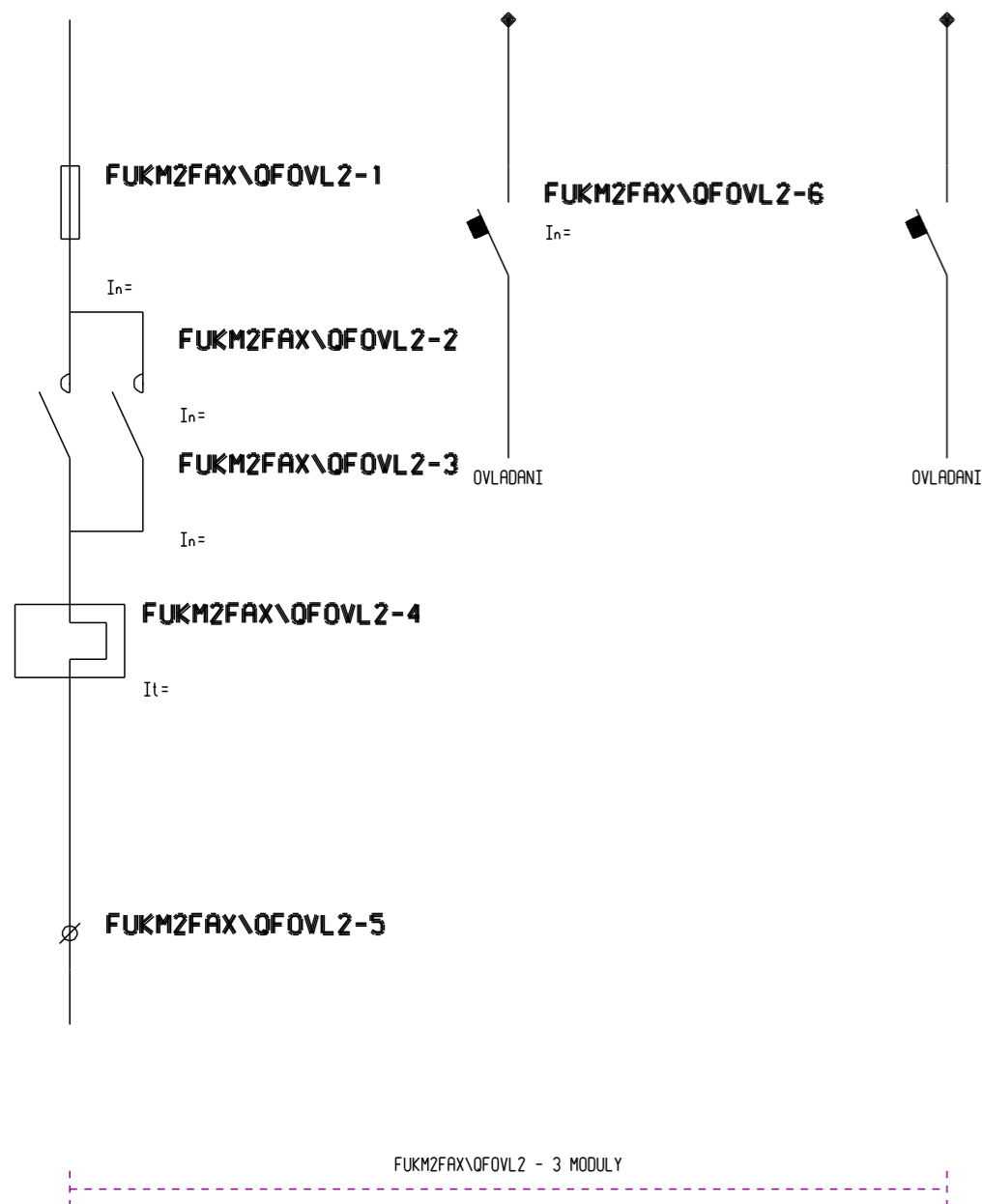

FUOVL\QF

### FUOVL\QF

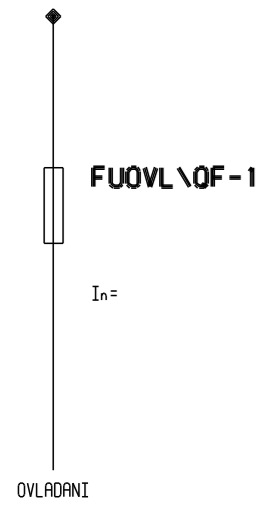

OVLADANI

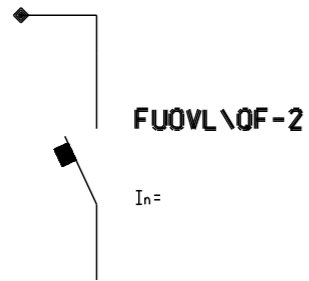

FUOVL\QF - 1 MODUL

FUKMX2\FUOVL

### FUKMX2\FUOVL

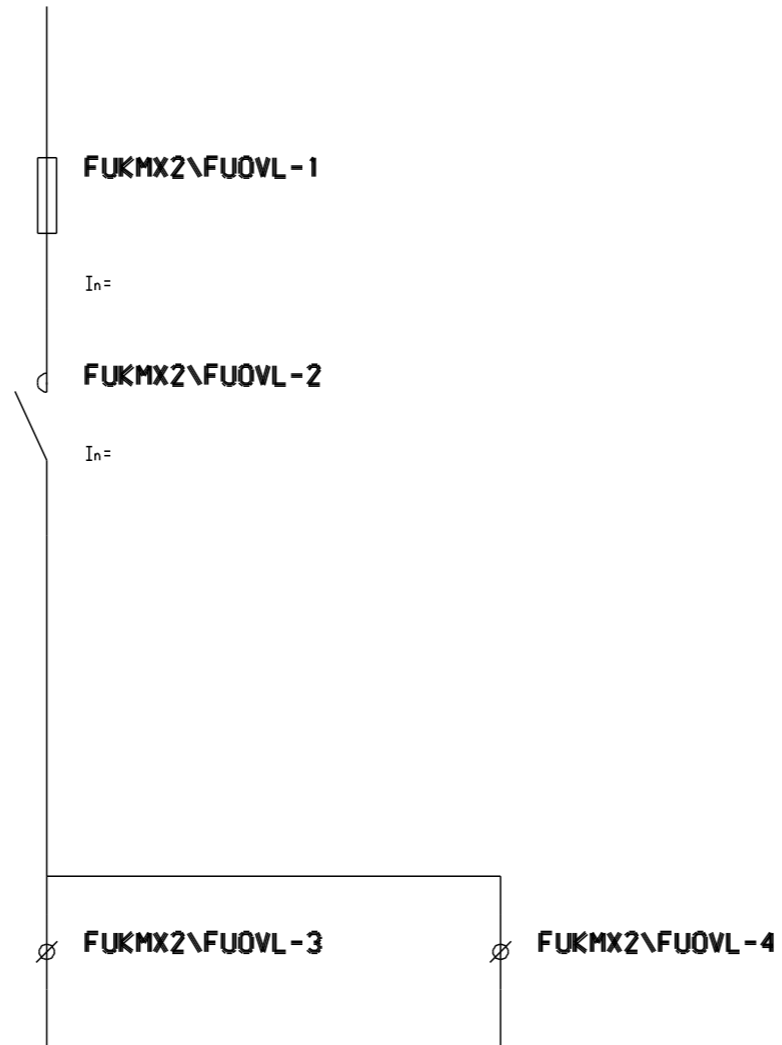

FUKMX2\FUOVL - 3 MODULY

PRFUOFFU\W2

### PRFUOFFU\W2

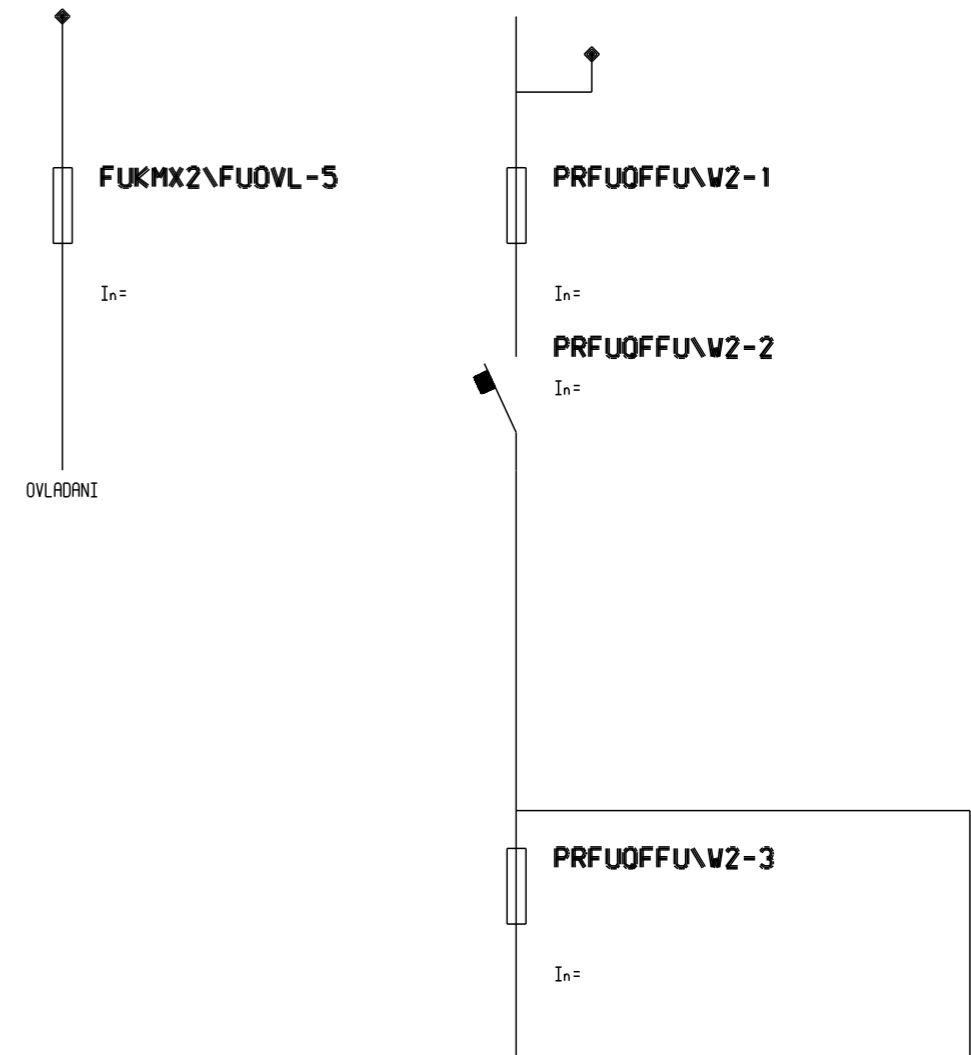

PRFUOFFU\W2 - 2 MODULY

FU\FU

# FU\FU

FUKMX\FUOVL2

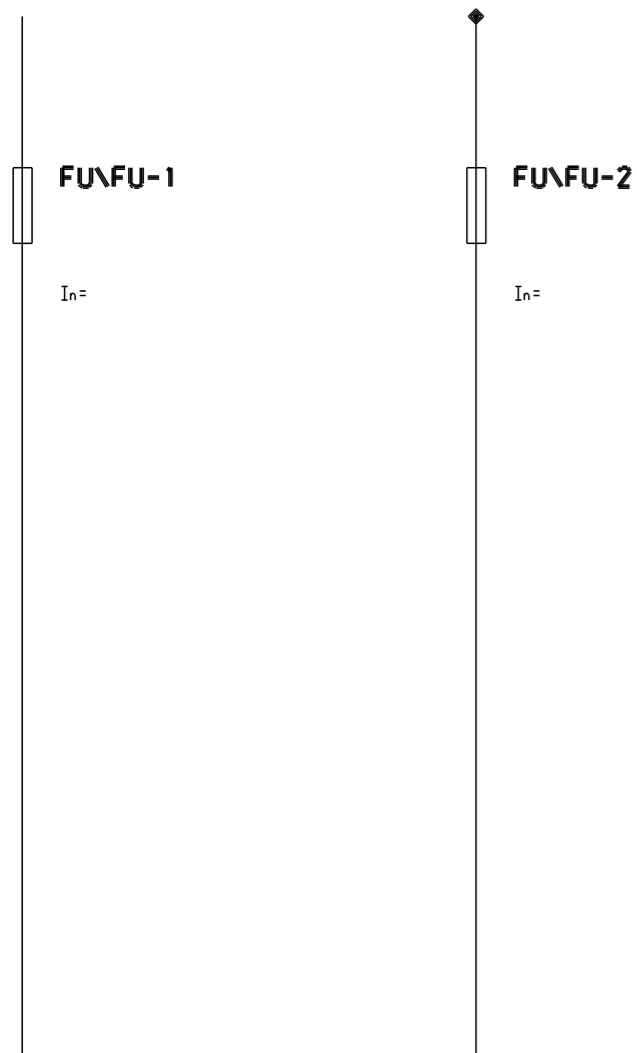

FU\FU - 2 MODULY

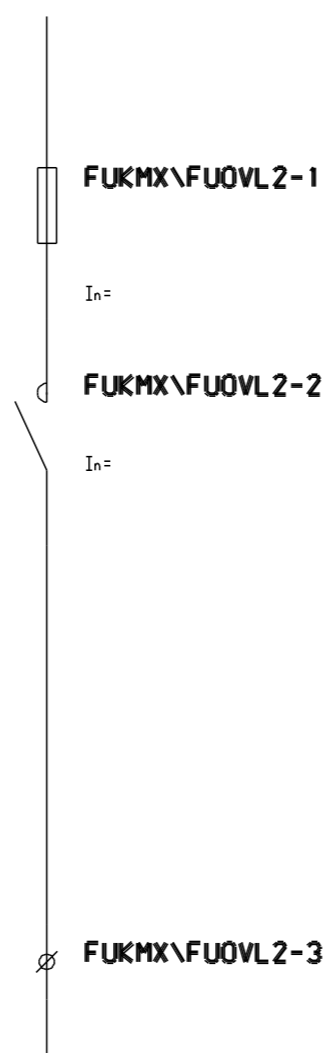

FUKMX\FUOVL2 - 5 MODULU

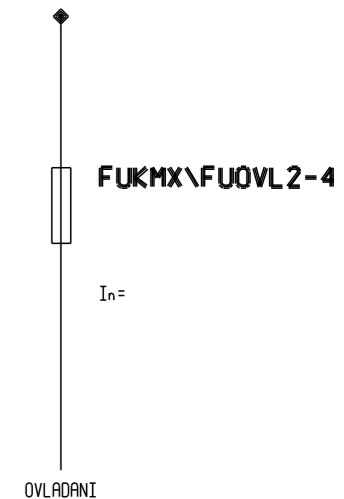

PRFUOFXW2

FUKMFAX1

FUKMX\FUOVL3

# PRFUOFXW2

# FUKMFAX1

# FUKMX\FUOVL3

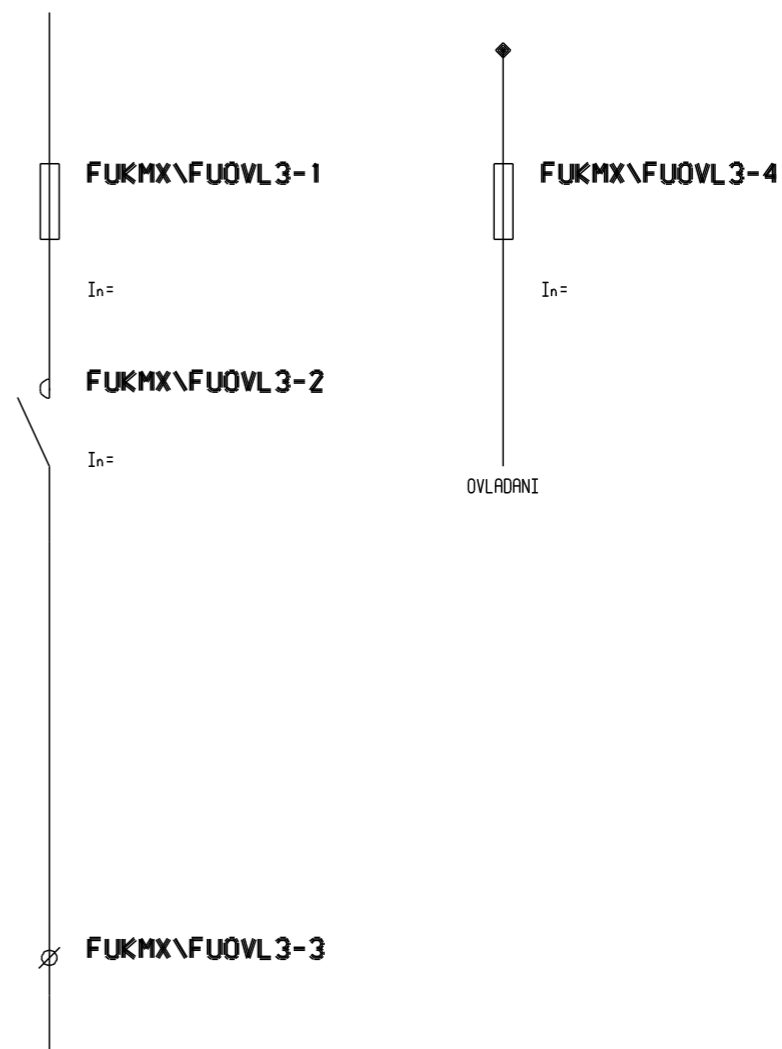
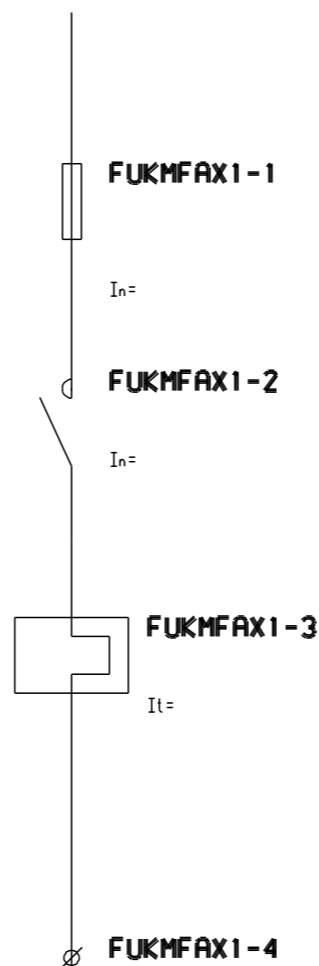
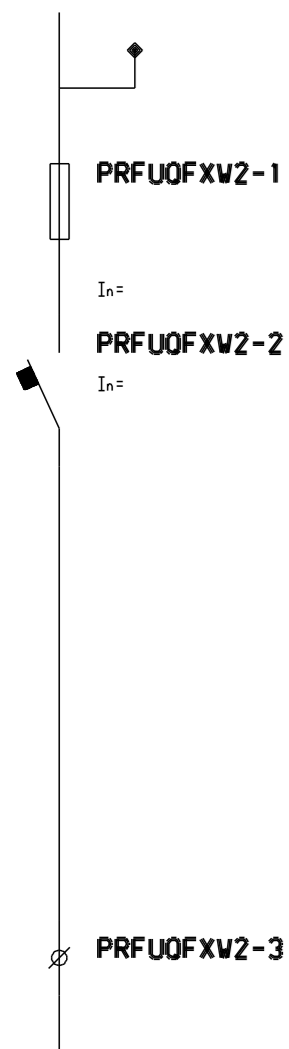

FUKMFAX1 - 1 MODUL

FUKMX\FUOVL3 - 2 MODULY

\FU

\FU

PRFUOF\FU2

\FU1

PRFUOF\FU2

\FU1

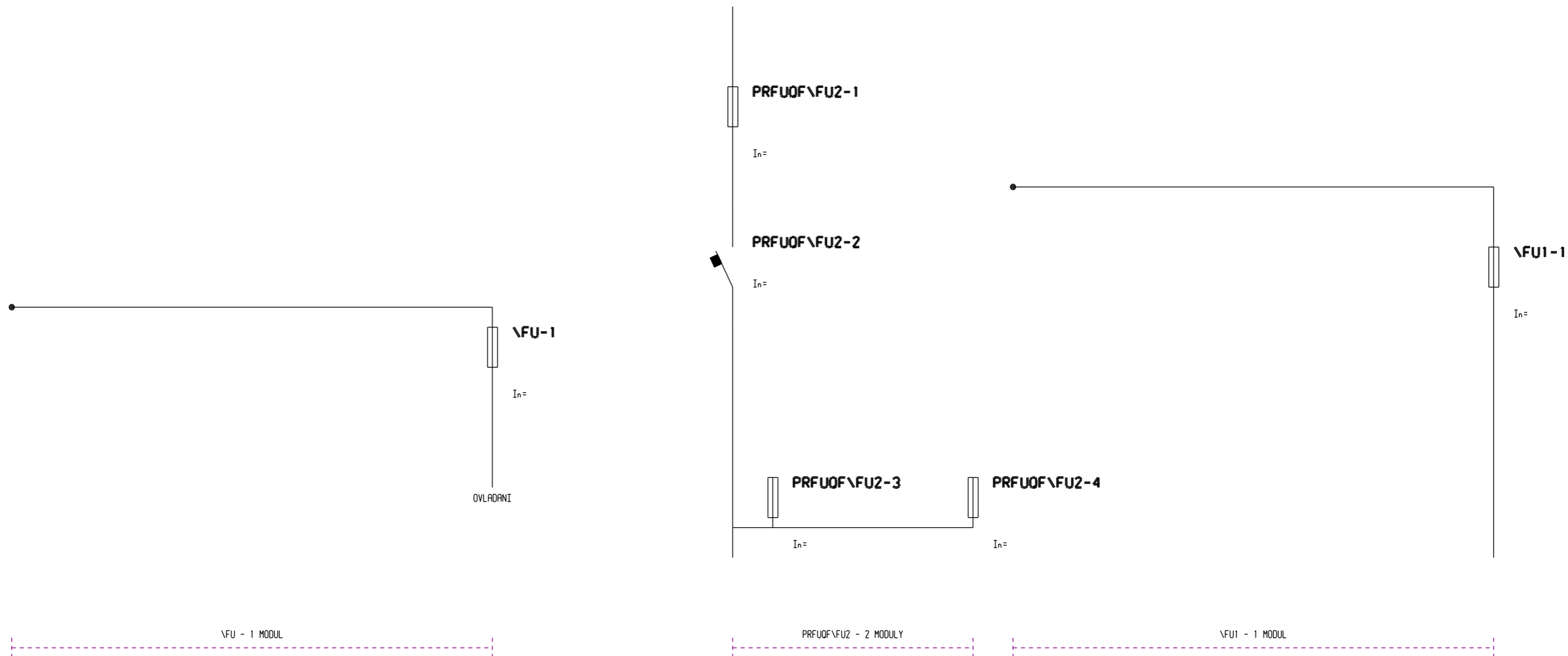

**\FU2**

\FU2

FUOVLNERENI

\FU2OVL

PRFUQFX\FU

**FUOVLNERENI**

**\FU2OVL**

**PRFUQFX\FU**

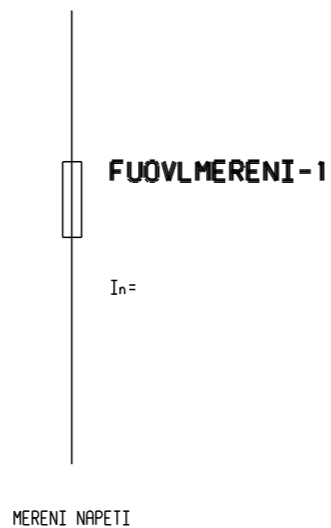

\FU - 1 MODUL

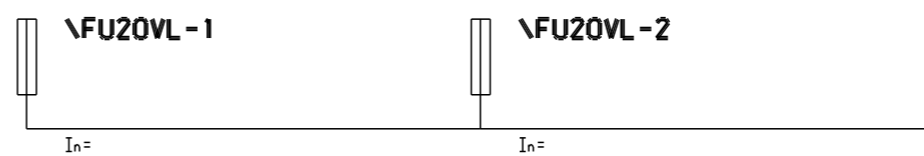

\FU2OVL - 2 MODULY

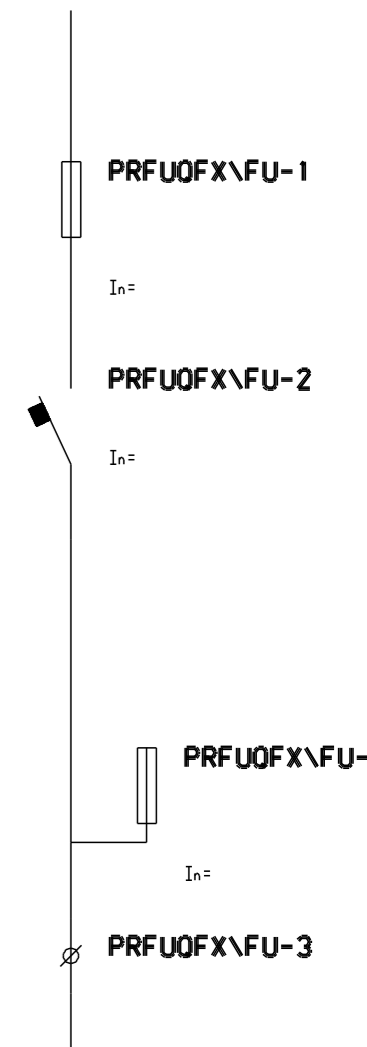



PRFUQF\FUFUOVL

FUKM\KM

OSFTA

OSFTAX

# PRFUQF\FUFUOVL

# FUKM\KM

# OSFTA

# OSFTAX

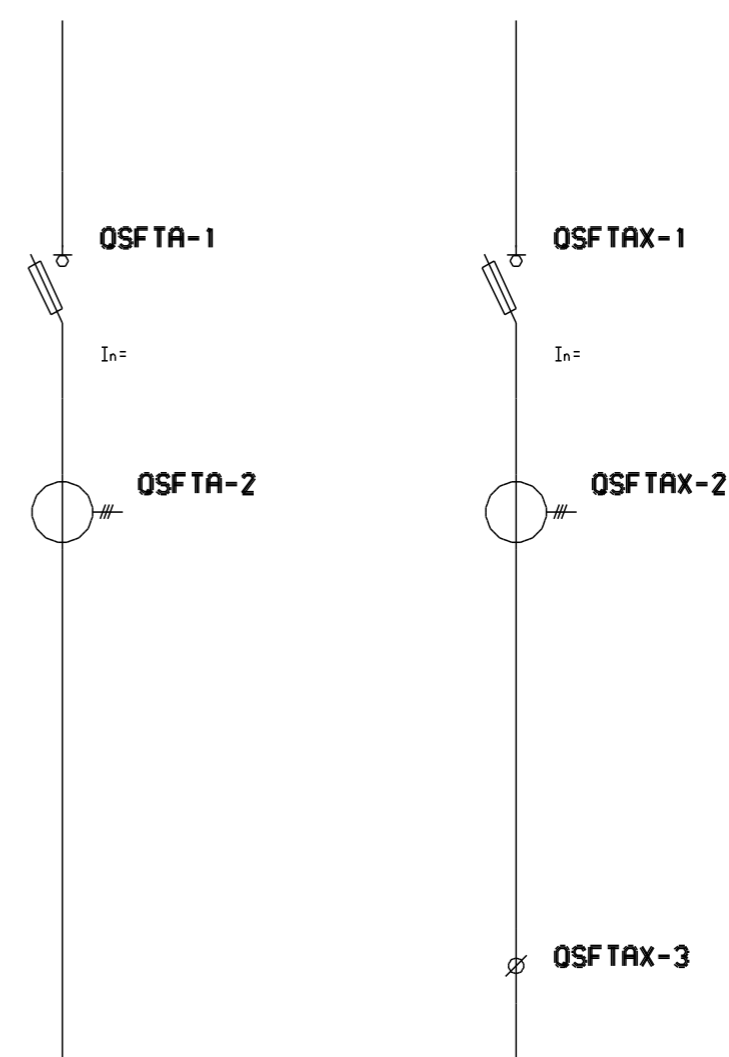
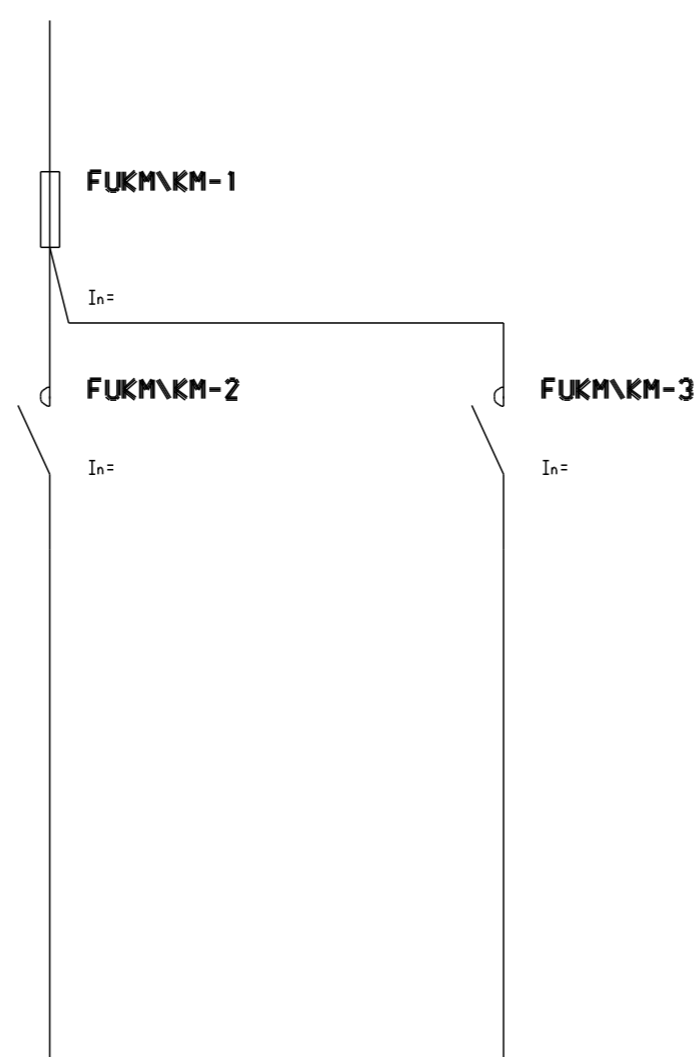
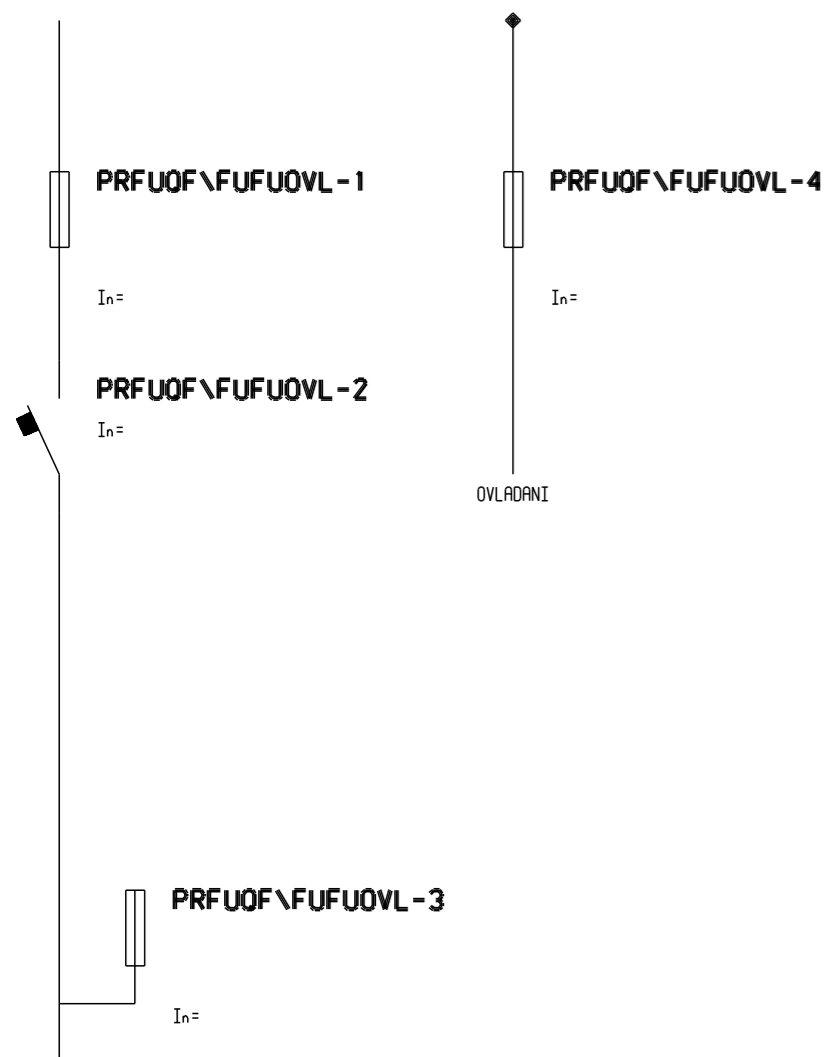

PRFUQF\FUFUOVL - 2 MODULY

FUKM\KM - 2 MODULY

PRFUKMXW2

\FUX

FUKM\FUOVL1

# PRFUKMXW2

# \FUX

# FUKM\FUOVL1

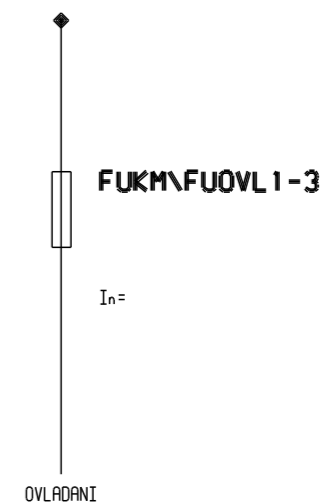
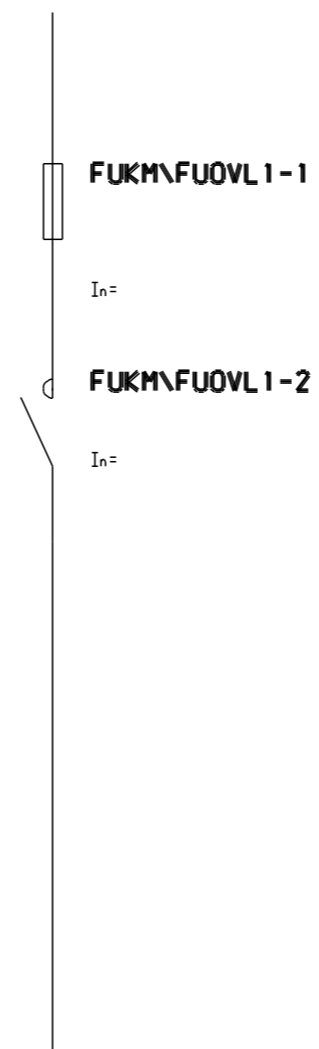
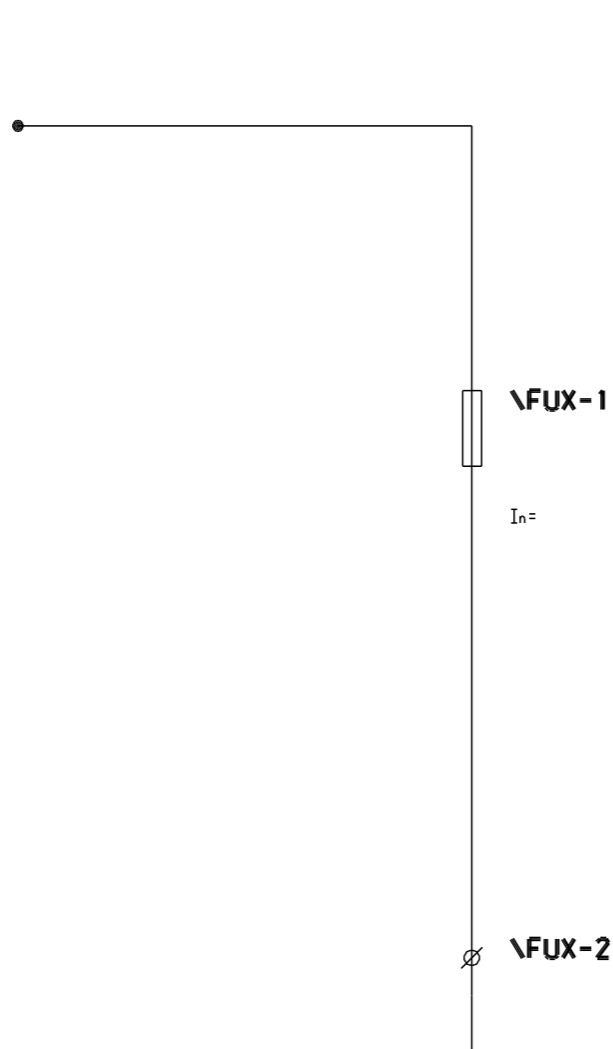
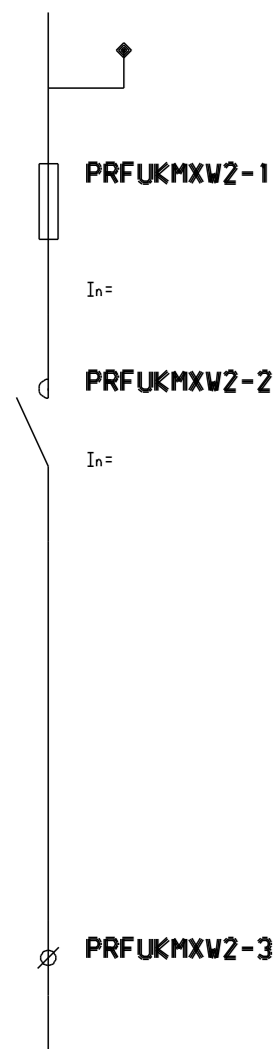

FUKM\FUOVL1 - 3 MODULY

FUQFKM\QFQFOVL

# FUQFKM\QFQFOVL

