

FU

FU

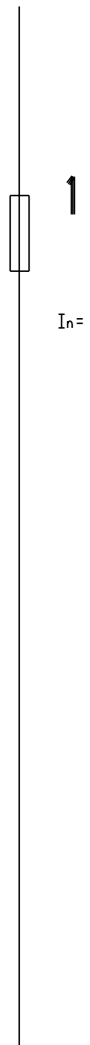

FUS

FUS

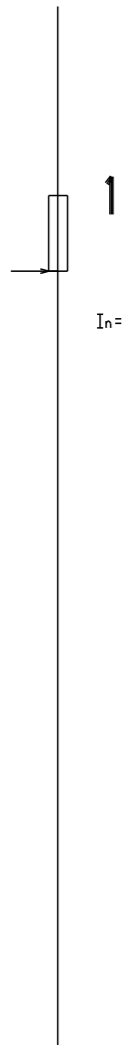

FUQM

FUQM

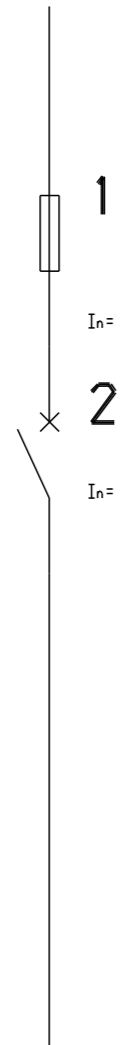

FUSQM

FUSQM

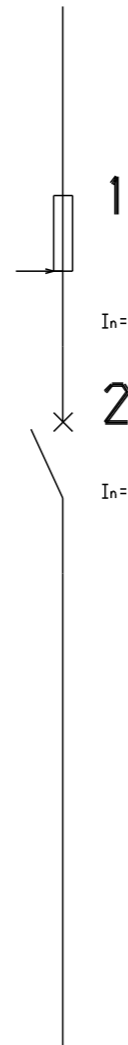

FUSQMTA1

FUSQMTA1

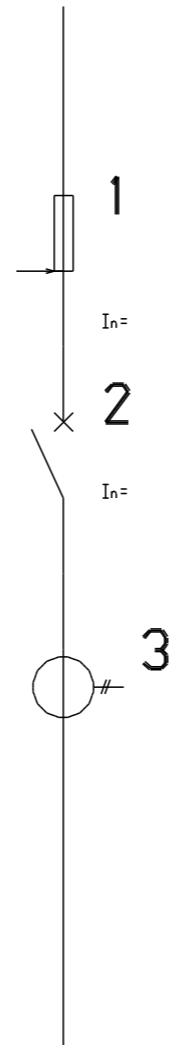

FUKM

FUKM

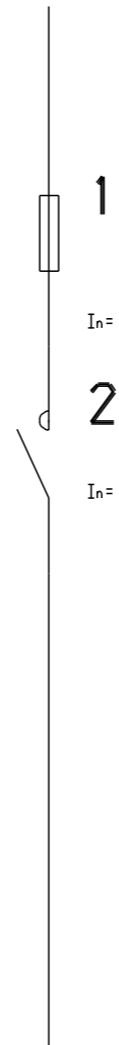

FUSKM

FUSKM

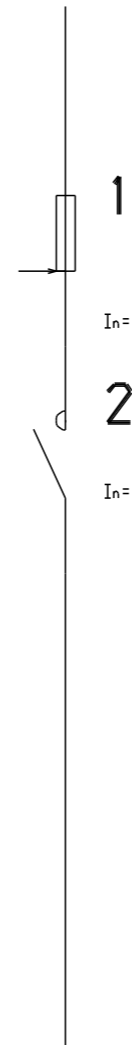

FUKMFA

FUKMFA

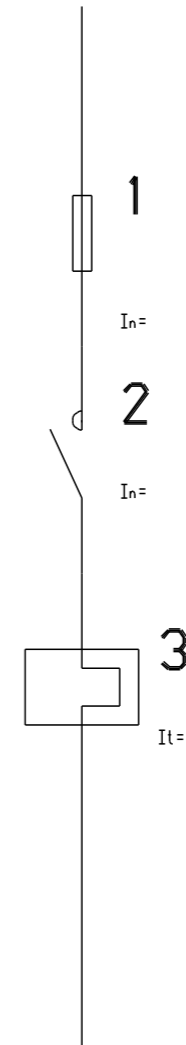

FUKMQF

FUKMQF

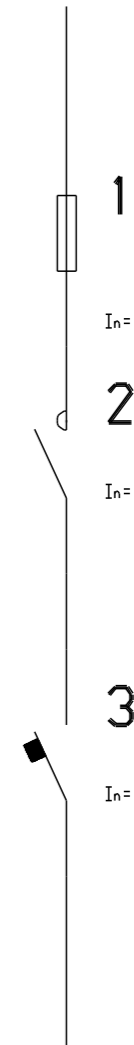

FUQF

FUQF

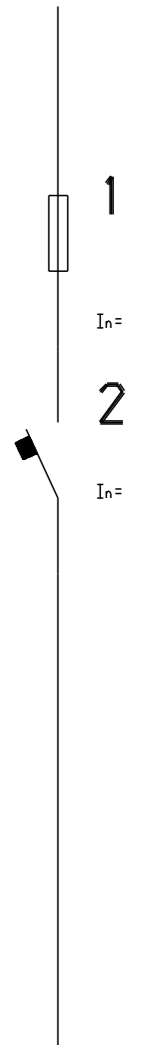

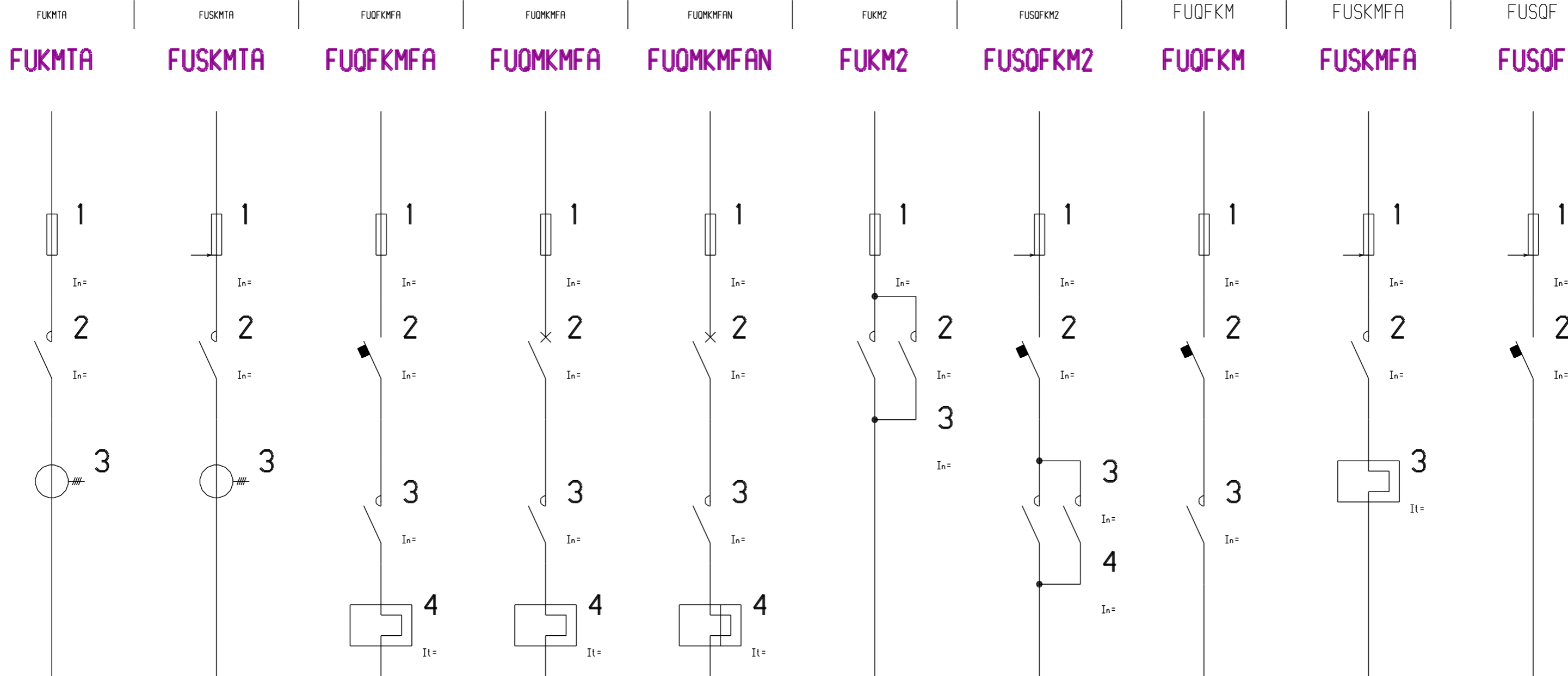

FU<QF>

FUTFU

FUSKMFAN

FUKMFAN

FUSQMFAN

FUD

FUQFKM\N

FUSQFKM

FUS<QM>

FUSFAKMFA

FU<QF>

FUTFU

FUSKMFAN

FUKMFAN

FUSQMFAN

FUD

FUQFKM\N

FUSQFKM

FUS<QM>

FUSFAKMFA

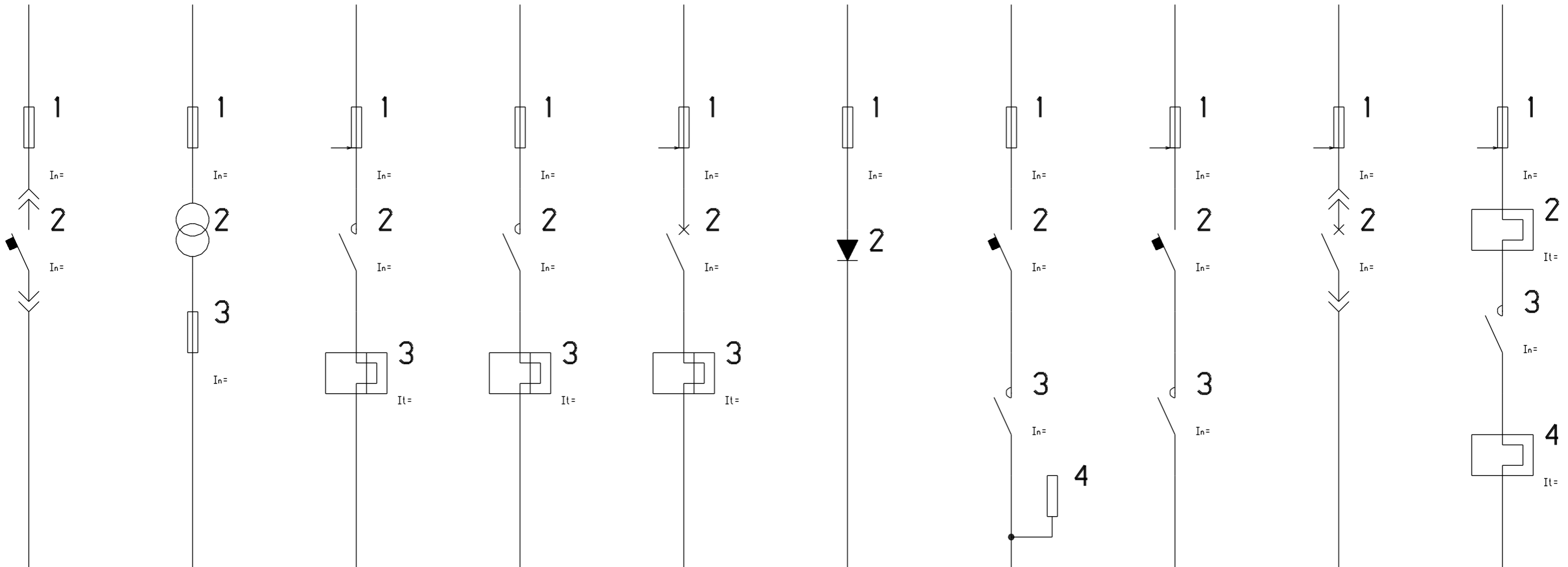

| | | | | | | | | | |
|----------------|---------------------|----------------|----------------------------|-------------|----------------|--------------|-----------------|----------------|---------------|
| FUSFAKM | PRFUTA1QM\FU | PRFUQMX | PRFUS<QM>\FUS | FUSZ | PRFUSQM | FUSFA | FUSKM2FA | FUSQMPA | FUSQMX |
| FUSFAKM | PRFUTA1QM\FU | PRFUQMX | PRFUS<QM>\FUS | FUSZ | PRFUSQM | FUSFA | FUSKM2FA | FUSQMPA | FUSQMX |

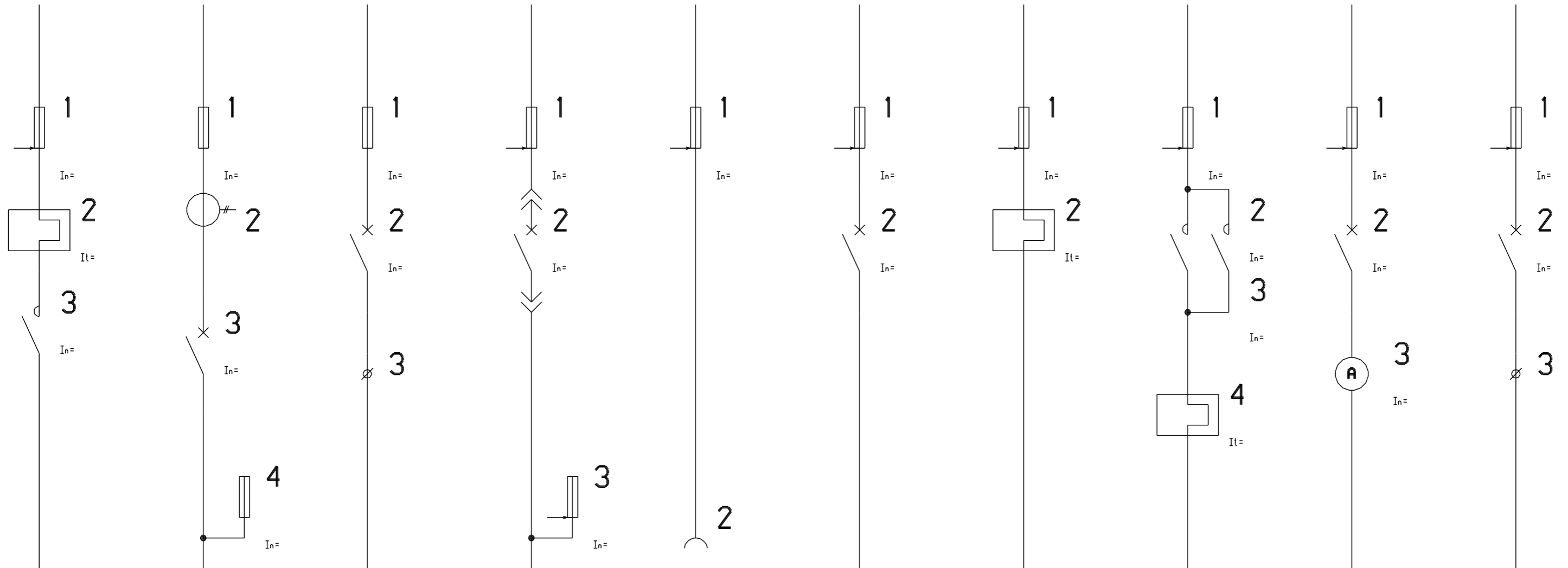

PRFUTA1<QM>\FU | PRFUTA1<QM>\FU\

PRFUTA1<QM>\FU PRFUTA1<QM>\FU\QF

FUSQFKM\R

FUSQFKM\R

FUS<QF>

FUS<QF>

FUKM2FA

FUKM2FA

FUQMFI

FUQMFI

FUSQMFI

FUSQMFI

FUTQF

FUTQF

FUZ

FUZ

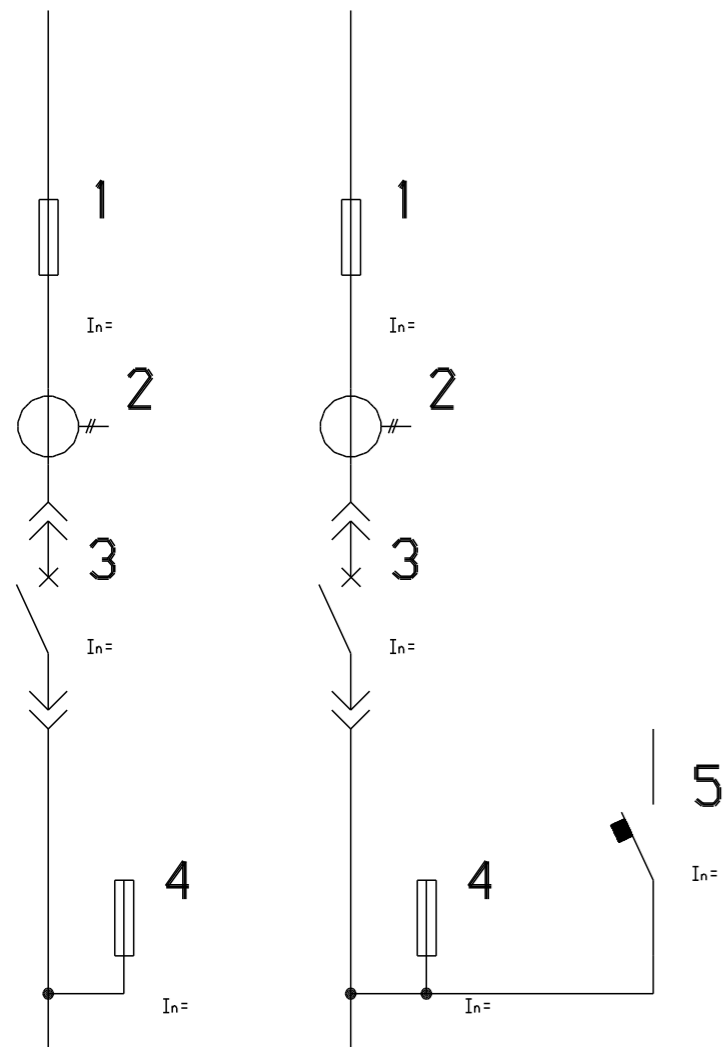

PRFUTA1<QM>\FU\QF - 2 MODULY

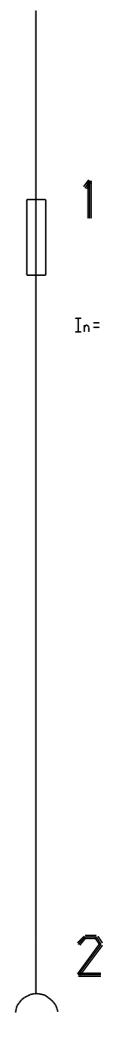
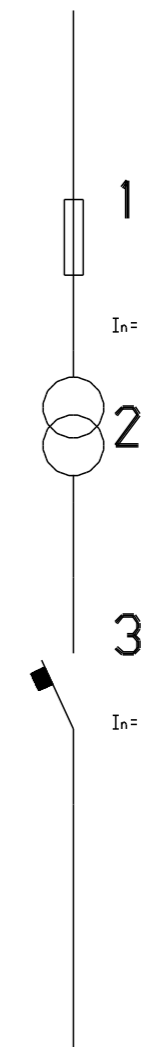
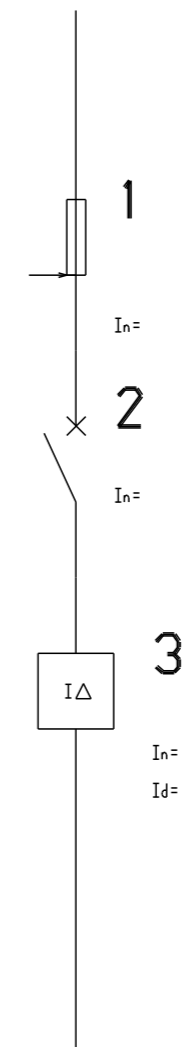
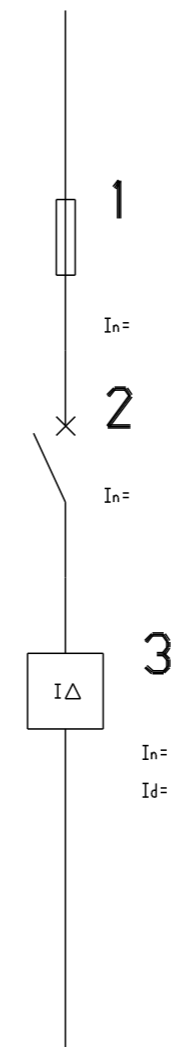
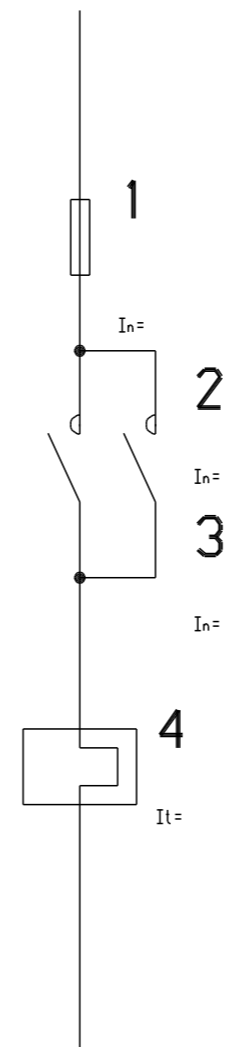
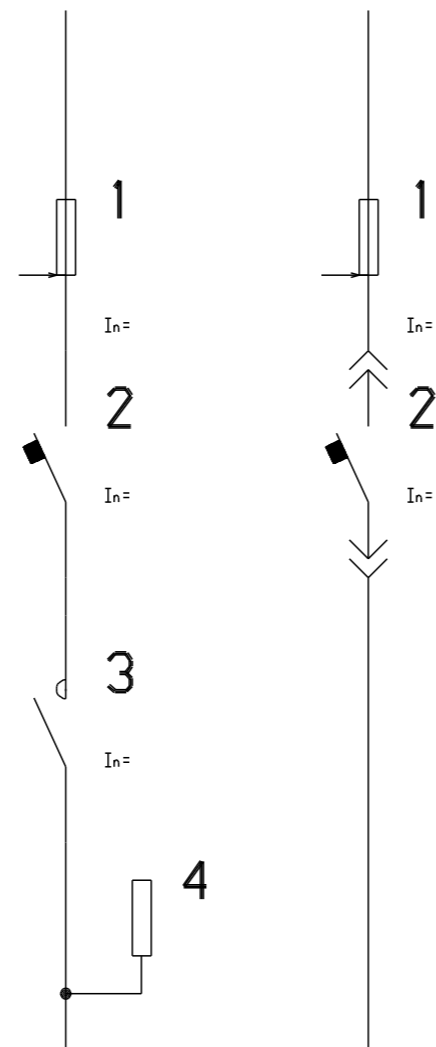

FUKM\IL2QF

FUKM\IL3QF

FUKML123

FUKML1

FUS\QF

FUS<QM>RA

FUSQFKMFA

PRFU

FUKM\IL2QF

FUKM\IL3QF

FUKML123

FUKML1

FUS\QF

FUS<QM>RA

FUSQFKMFA

PRFU

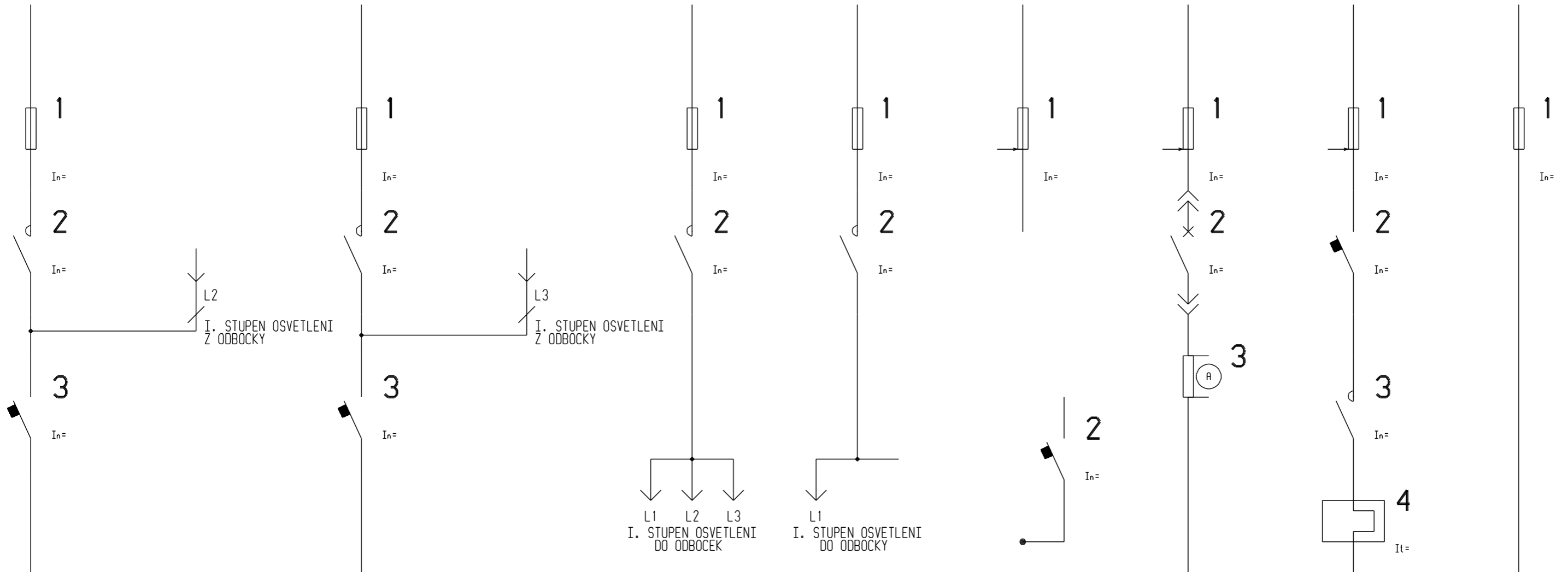

FUKM\IL2QF - 2 MODULY

FUKM\IL3QF - 2 MODULY

PRFUS<QF>\FUS | FUS<QF>TA | PRFUS<QF>TA1\FU

FUSQFTA | FU\FAKM

FUQFQM | PRFUS<QM>RA\FUS | FUKM\IL1QF

PRFUS<QF>\FUS

FUS<QF>TA

PRFUS<QF>TA1\FUS

FUSQFTA

FU\FAKM

FUQFQM

PRFUS<QM>RA\FUS

FUKM\IL1QF

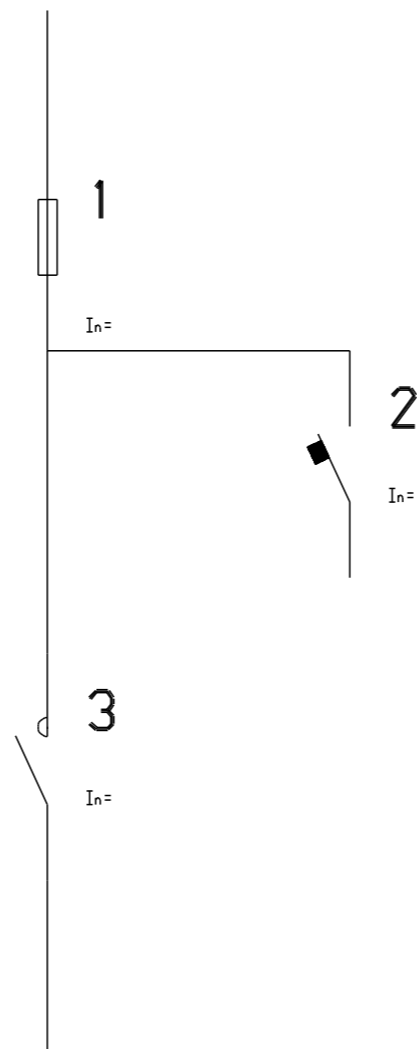
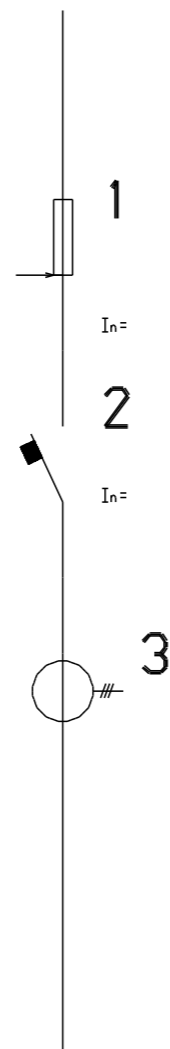
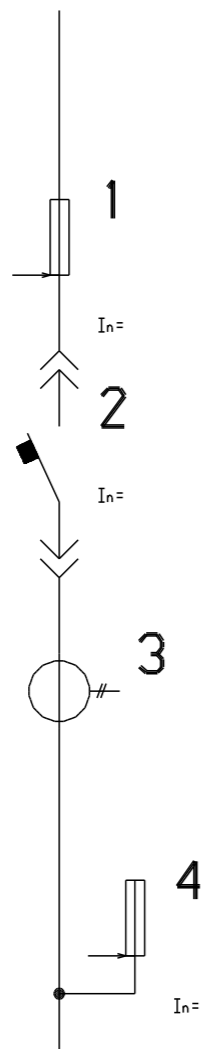
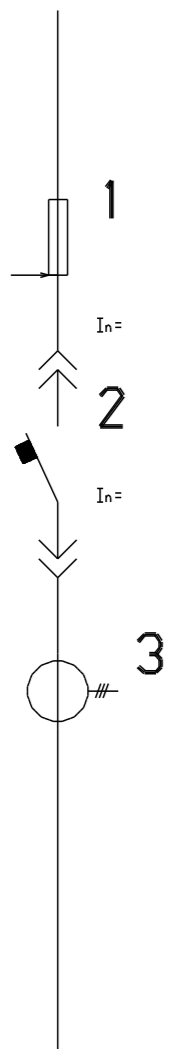
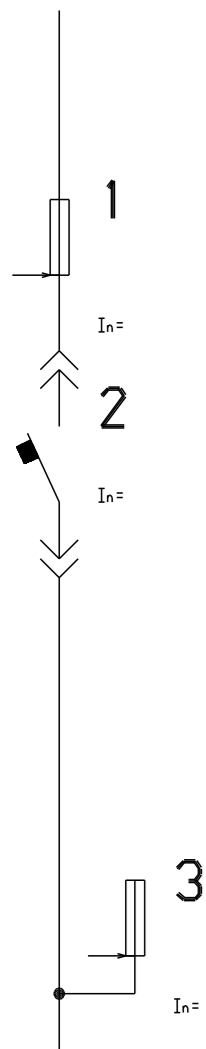

FU\FAKM - 2 MODULY

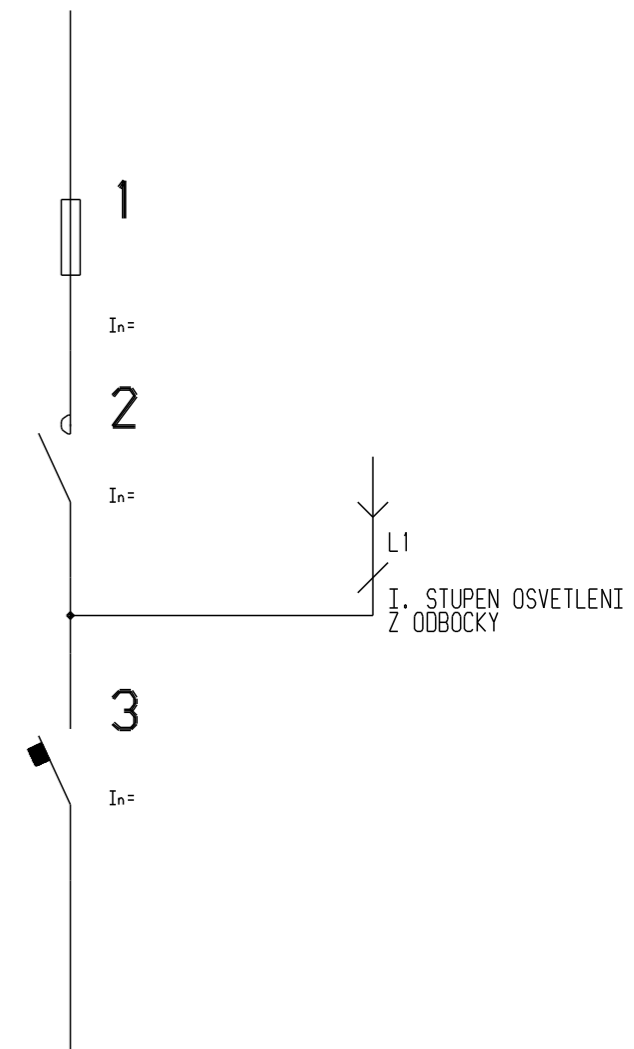
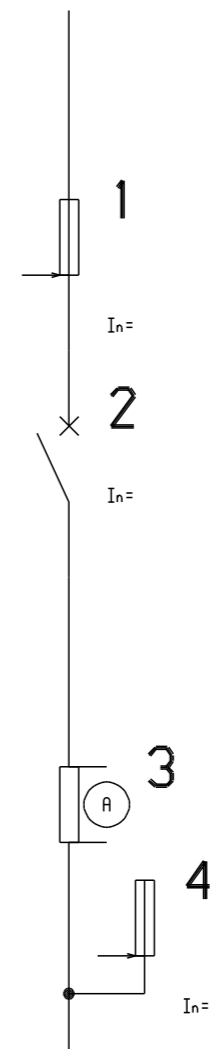
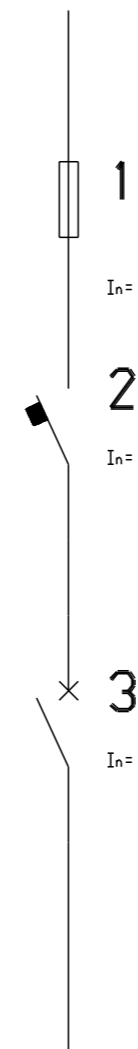

FUKM\IL1QF - 2 MODULY

\FUS2TA1<QF>\FU

FUSKMQF

FUFV

FUSQMKM

FUQMKMFANTA

FUSKMFANTA

FUKMFANTA

FUSQFKM\KM2

\FUS2TA1<QF>\FUS

FUSKMQF

FUFV

FUSQMKM

FUQMKMFANTA

FUSKMFANTA

FUKMFANTA

FUSQFKM\KM2

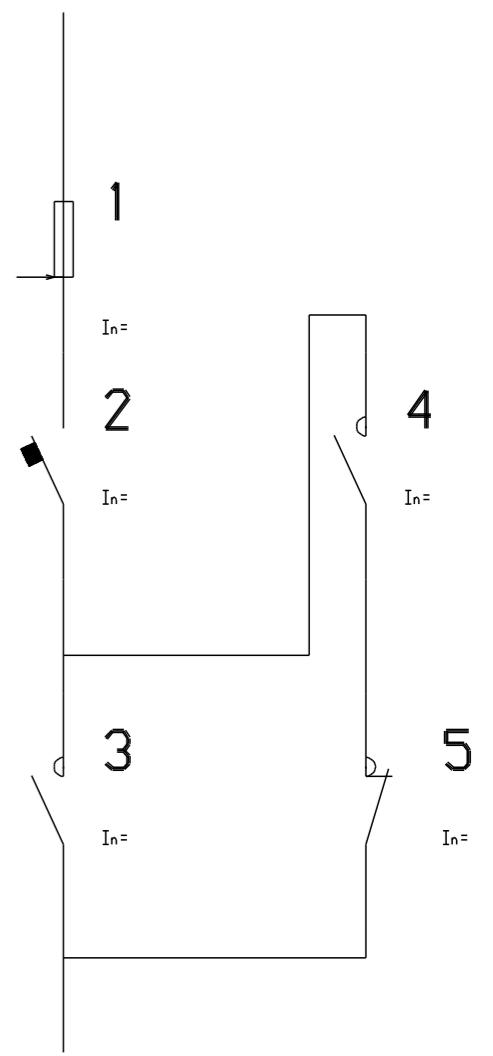
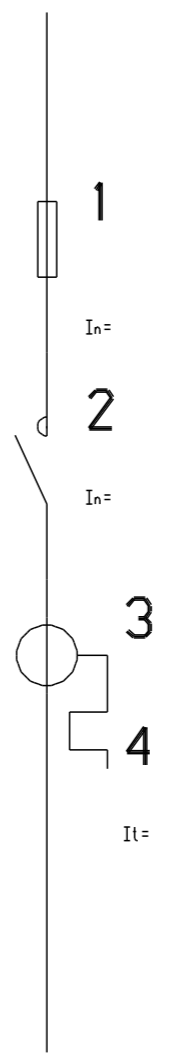
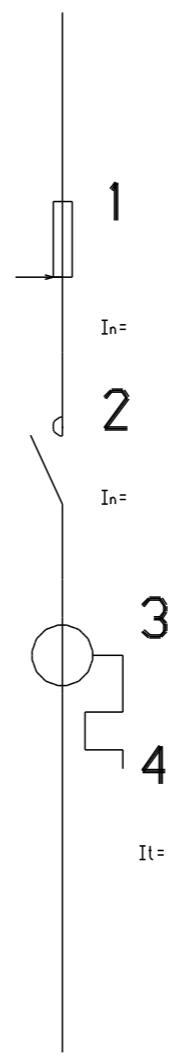
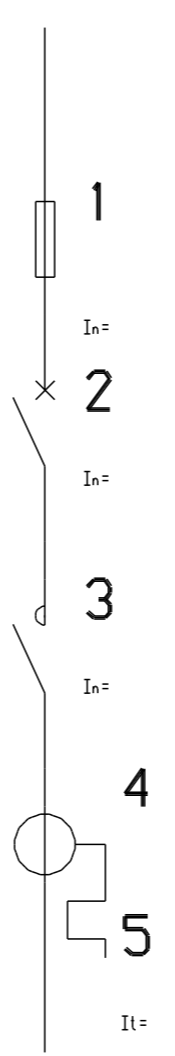
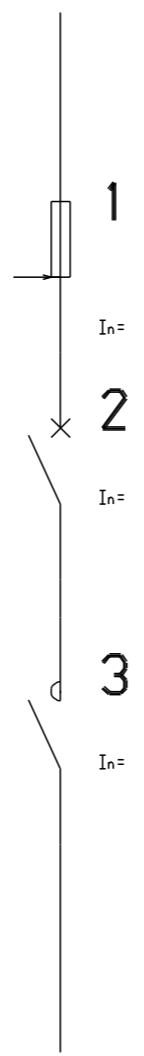
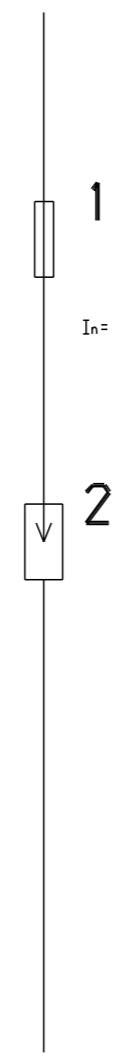
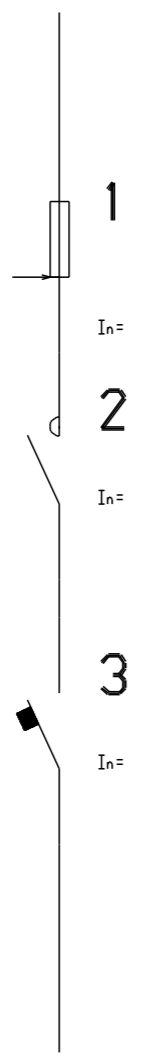
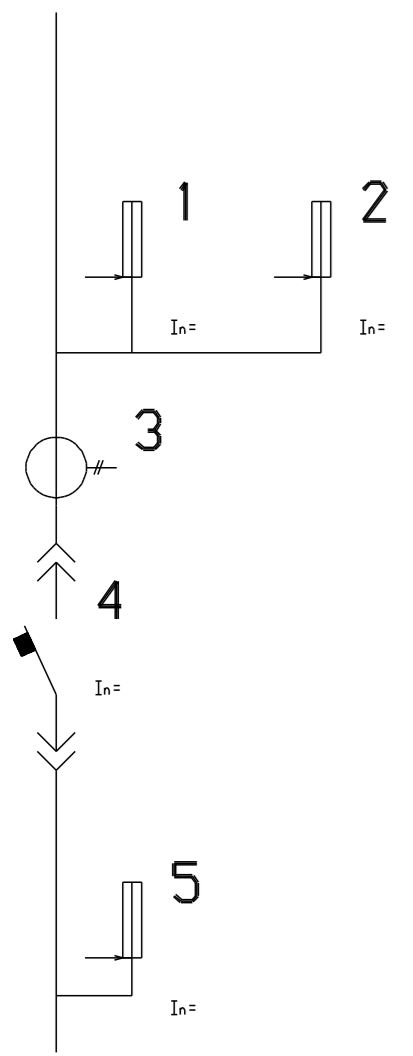

\FUS2TA1<QF>\FUS - 2 MODULY

FUSQFKM\KM2 - 2 MODULY

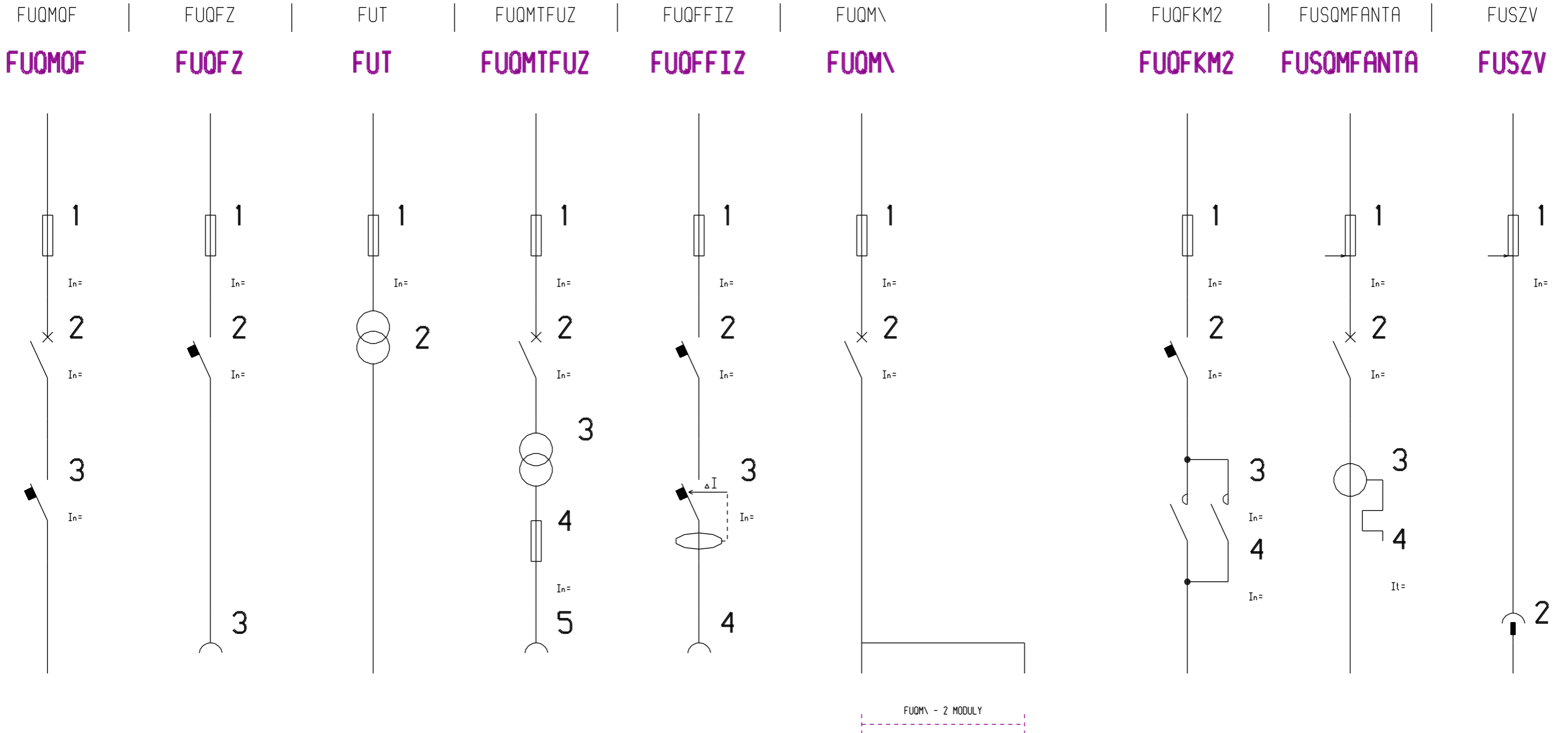

FUKMQF6\QF

FUKMQF6\QF

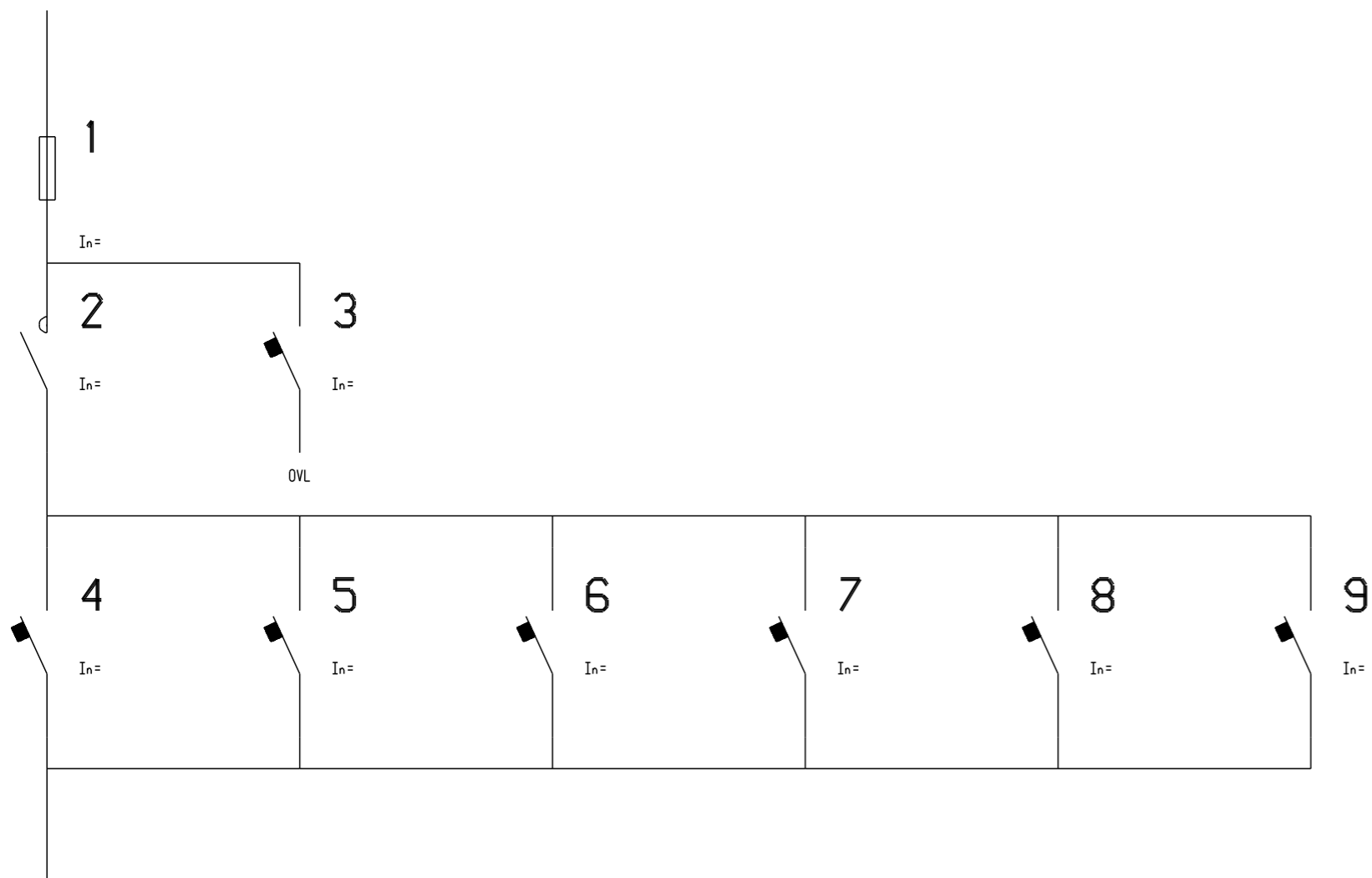

FUKMQF6\QF - 6 MODULU

FUSKMFAX

FUSKMFAX

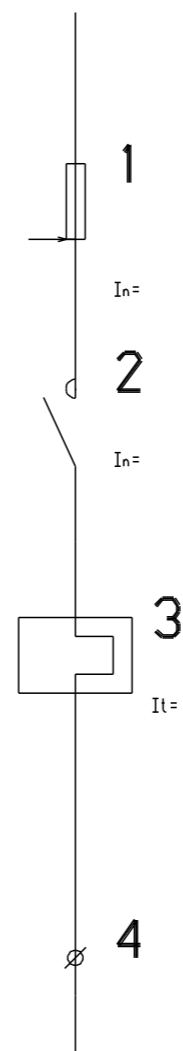

FUTFUZ

FUTFUZ

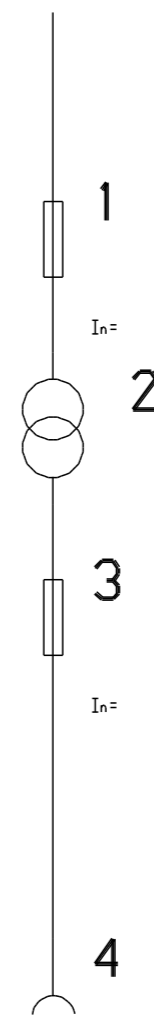

FUX

FUX

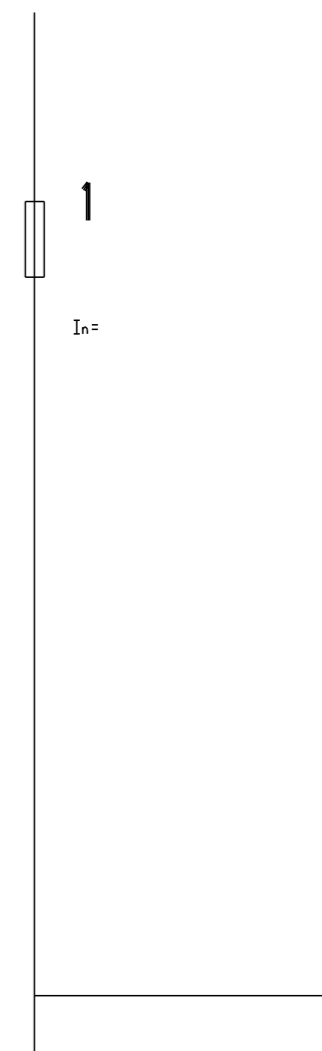

FUX - 2 MODULY

FUKMQF6\QF\QF

FUKMQF6\QF\QF

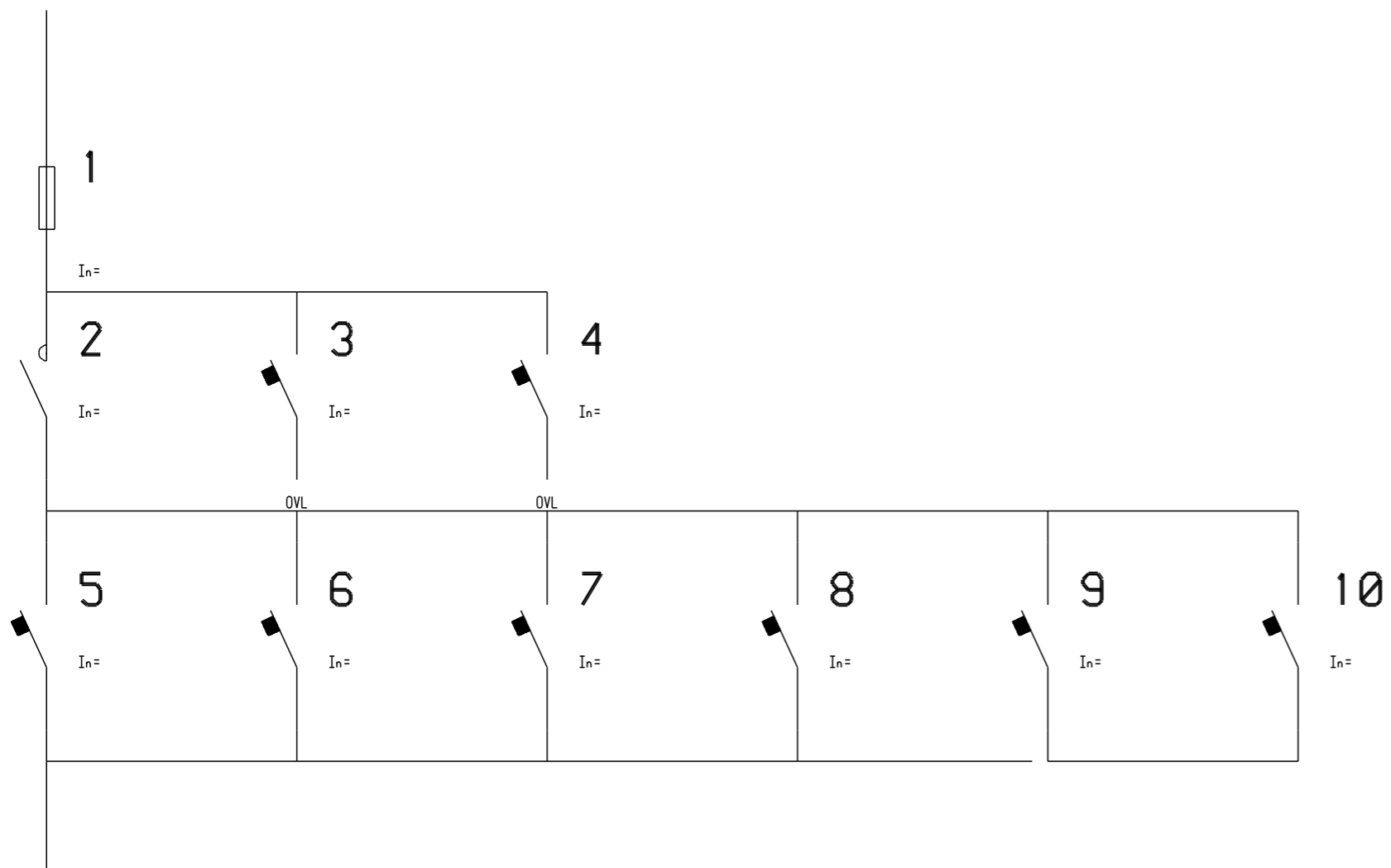

FUKMQF6\QF\QF - 6 MODULU

FUSX

FUSX

FUKMFA\KM\KM

FUKMFA\KM\KM

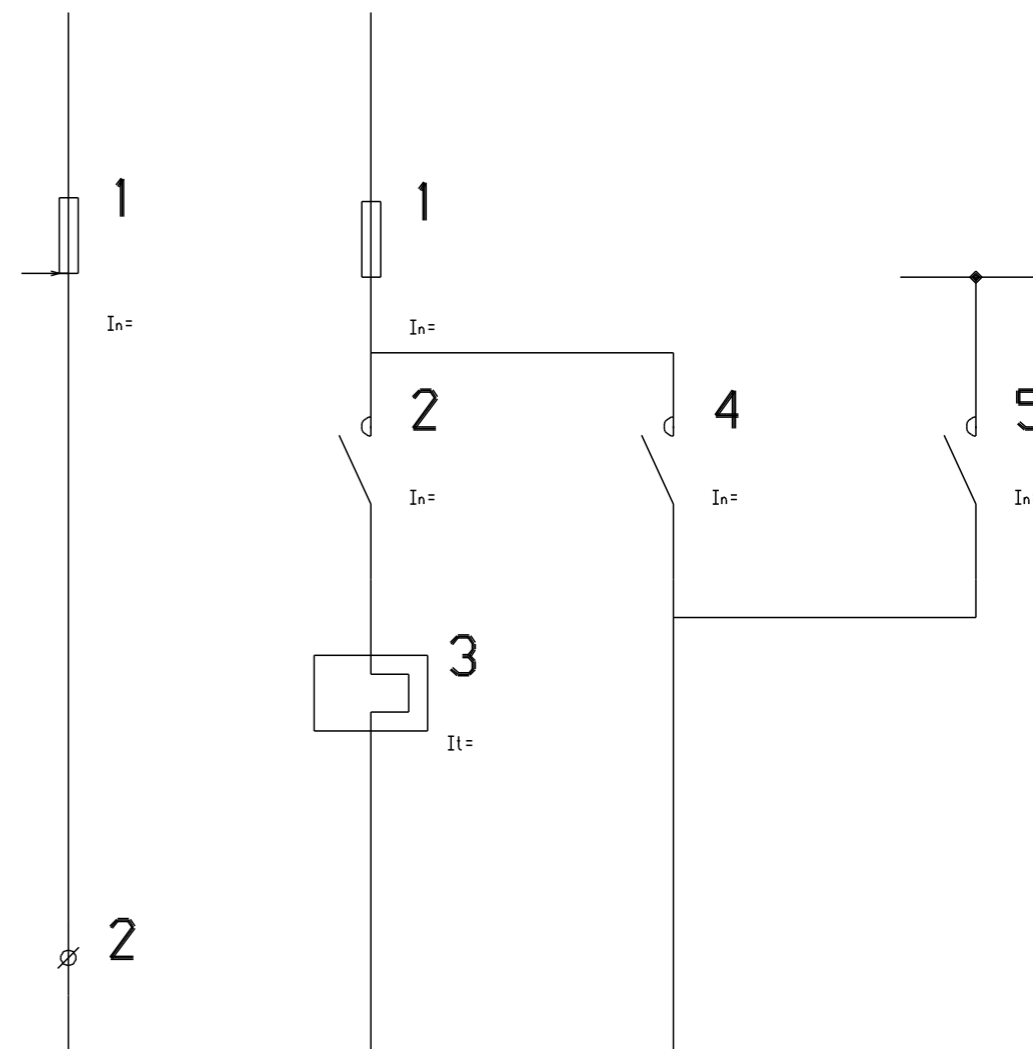

FUKMFA\KM\KM - 3 MODULY

FU\QFQF\KM

FUKMF\KMFA

PRFUQM

FUKA

FUOVLBP

FUOVL

FUSOVL

FUSOVLBP

FU\QFQF\KM

FUKMF\KMFA

PRFUQM

FUKA

FUOVLBP

FUOVL

FUSOVL

FUSOVLBP

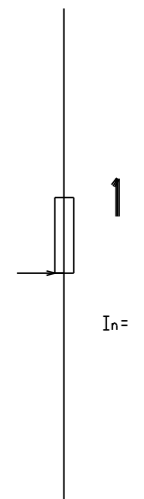
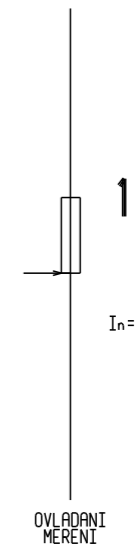
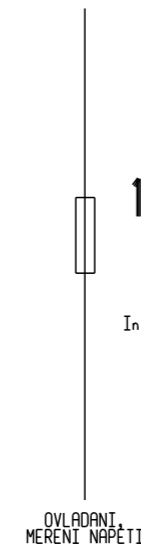
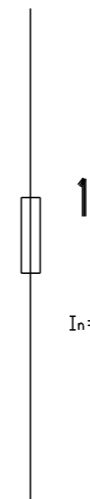
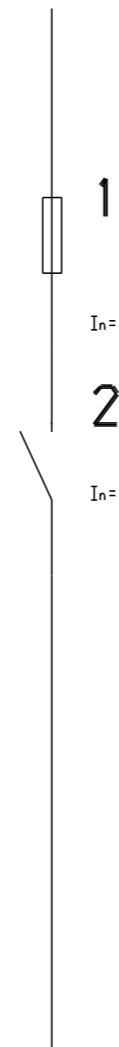
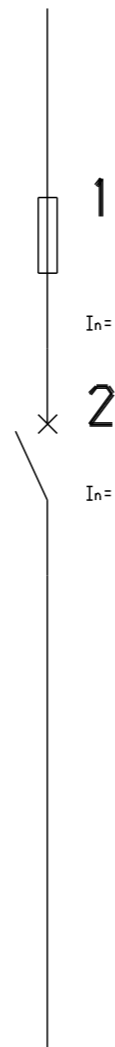
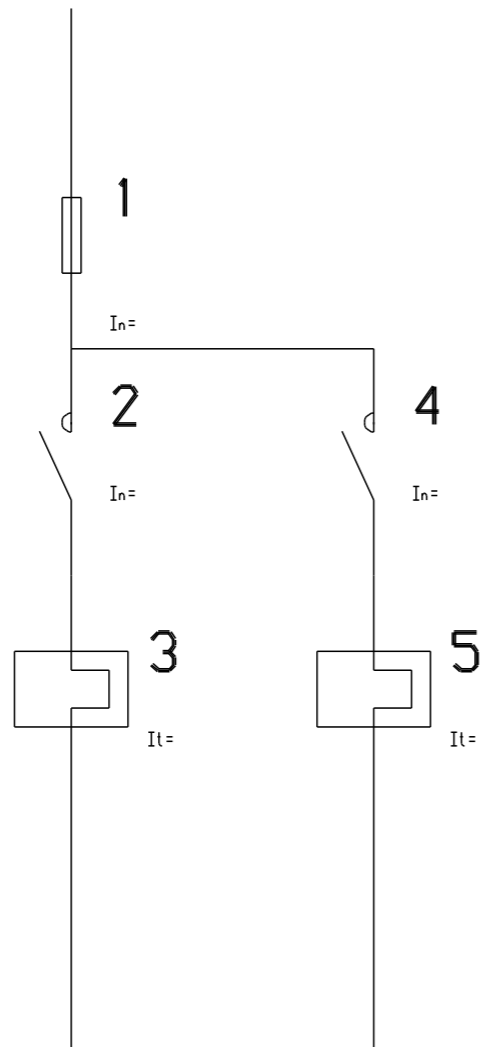
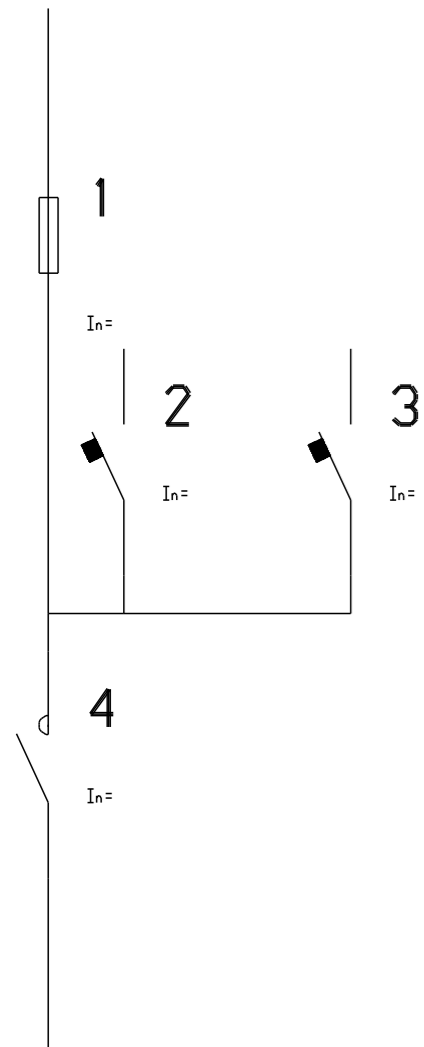

FU\QFQF\KM - 2 MODULY

FUKMF\KMFA - 2 MODULY

FUKMFANFU

PRFUKMQM

FUQM\QF

FUOVLKM

FUKM\

FUKMFANFU

PRFUKMQM

FUQM\QF

FUOVLKM

FUKM

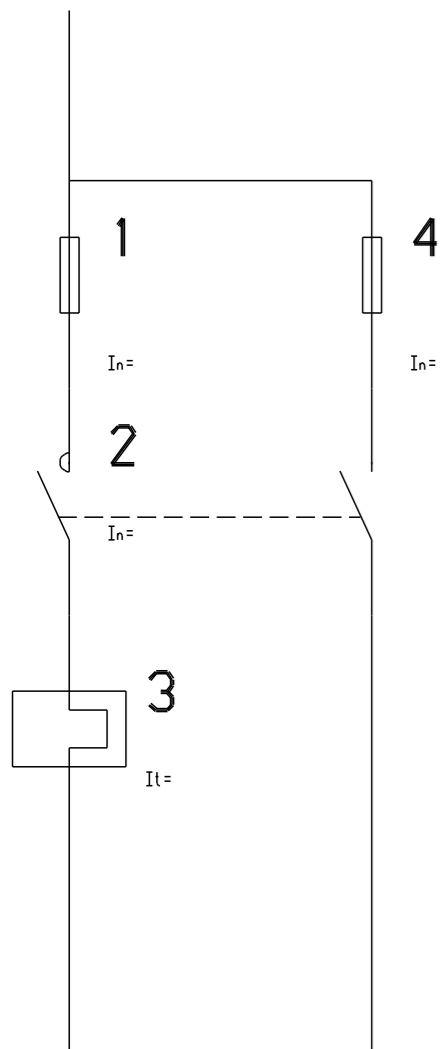

FUKMFANFU - 2 MODULY

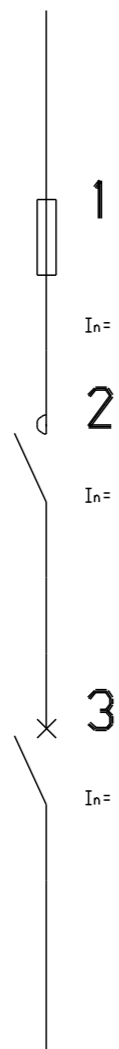

FUQM\QF - 2 MODULY

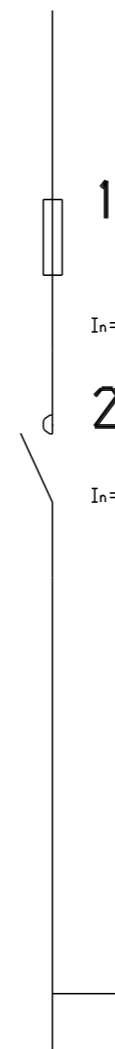
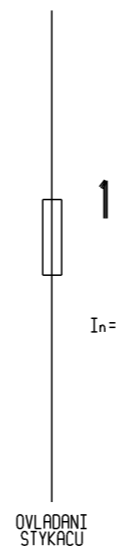
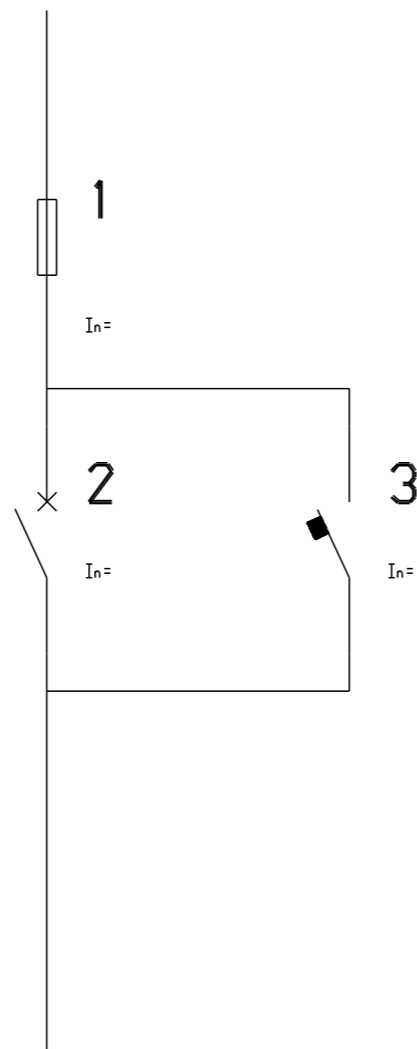

FUKM\ - 4 MODULY

PRFU\QFQF\KM

FUFV FV

FUKA OB

PRFUQF

FUKA OBQM

FUKM\QM

FUQMPREP

PRFU\QFQF\KM

FUFV FV

FUKA OB

PRFUQF

FUKA OBQM

FUKM\QM

FUQMPREP

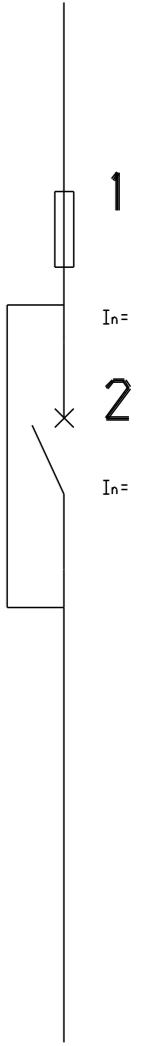
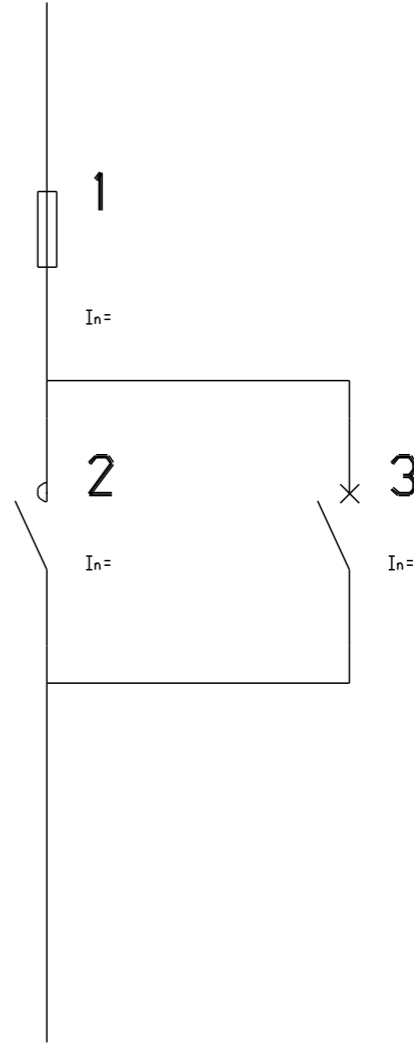
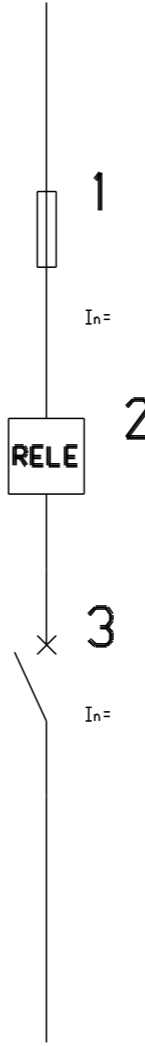
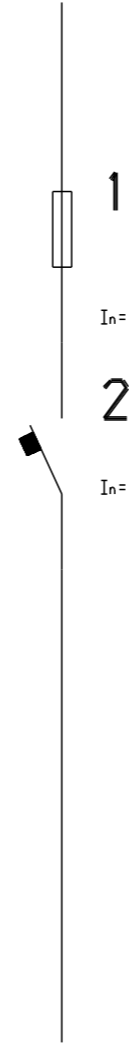
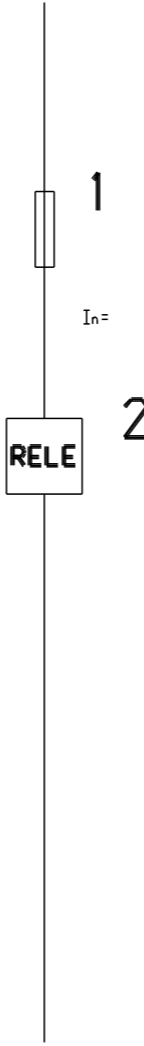
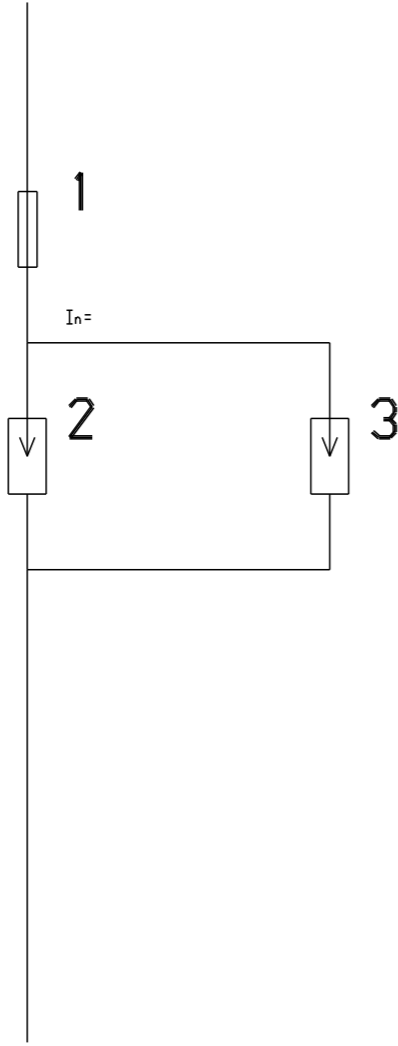
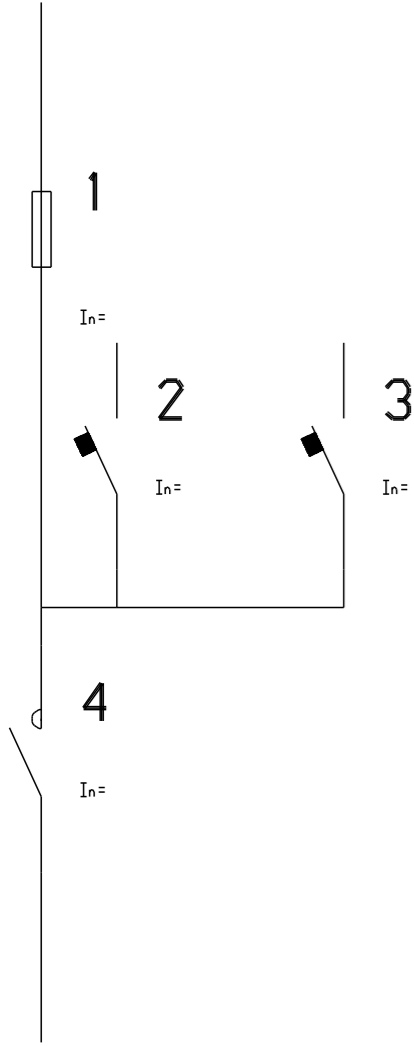

PRFU\QFQF\KM - 2 MODULY

FUFV FV - 2 MODULY

FUKM\QM - 2 MODULY

FUKMQF\QF

PRFUKM\FU

PRFUQF\FU

FUQFFIQM

FUFA

FU\FUKM

FUSA

FUKMFANTA\FU

FUKMQF\QF

PRFUKM\FU

PRFUQF\FU

FUQFFIQM

FUFA

FU\FUKM

FUSA

FUKMFANTA\FU

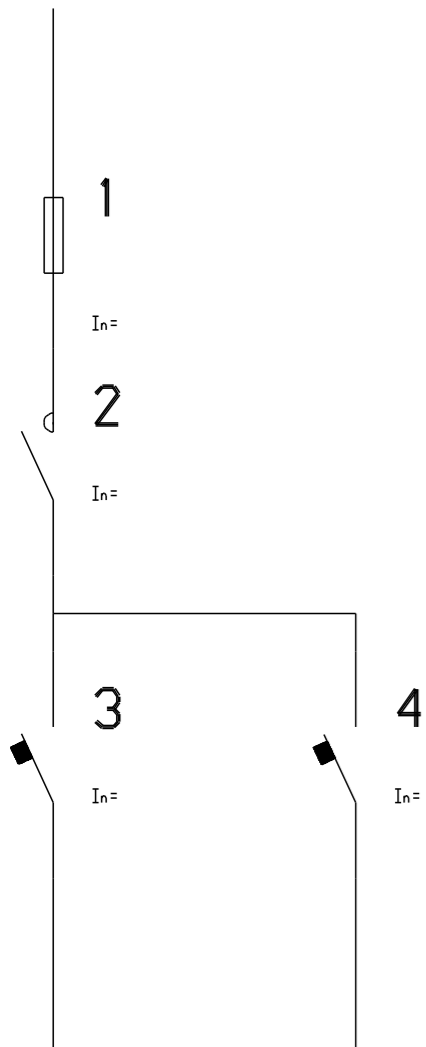

FUKMQF\QF - 2 MODULY

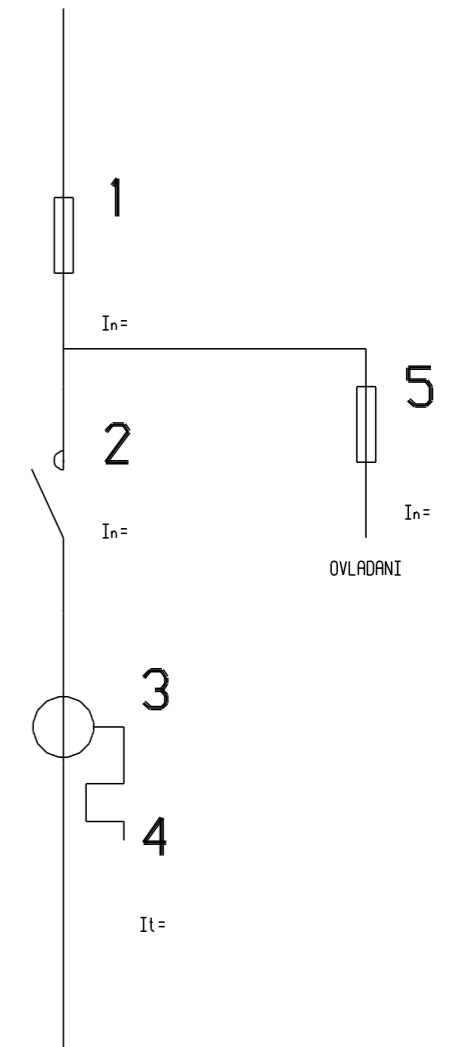
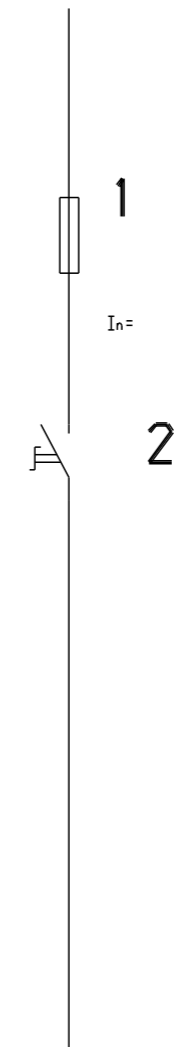
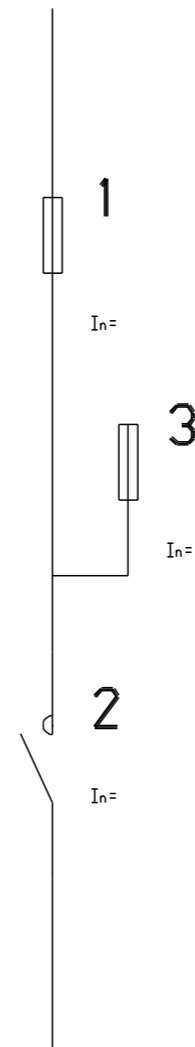
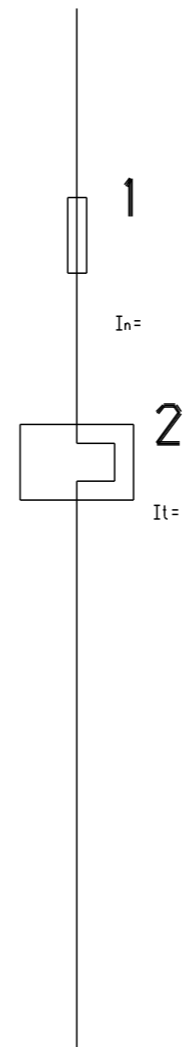
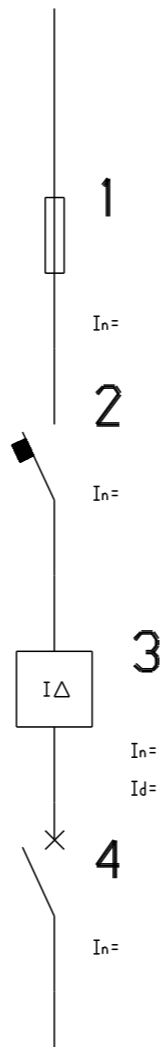
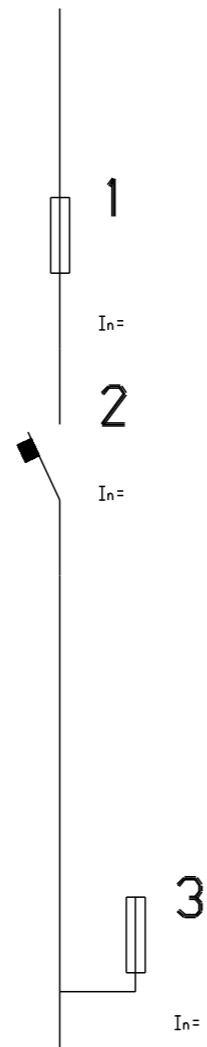
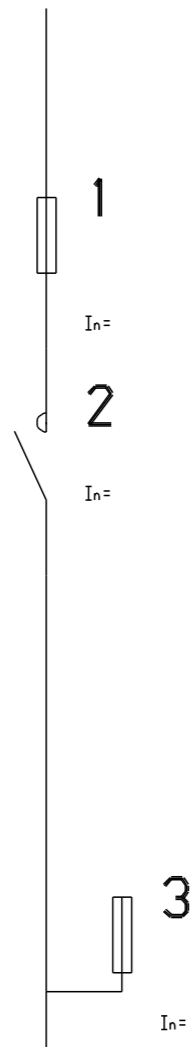

FUKMFANTA\FU - 2 MODULY

PRFUSKM\FU | FUQM\QFOVL

FUFI | FUKMFA\QF

FUVD | FUQF1FI | FUQF1FIZ | FUFUOVLBP

PRFUSKM\FU FUQM\QFOVL

FUFI FUKMFA\QF

FUVD FUQF1FI FUQF1FIZ FUFUOVLBP

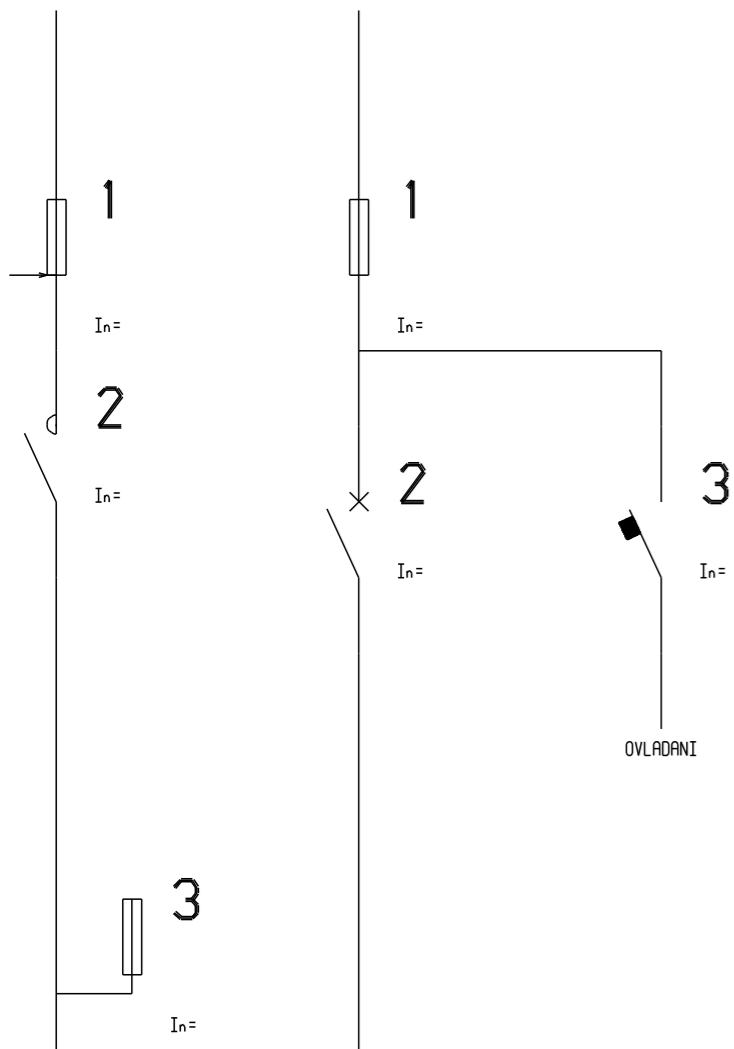

FUQM\QFOVL - 2 MODULY

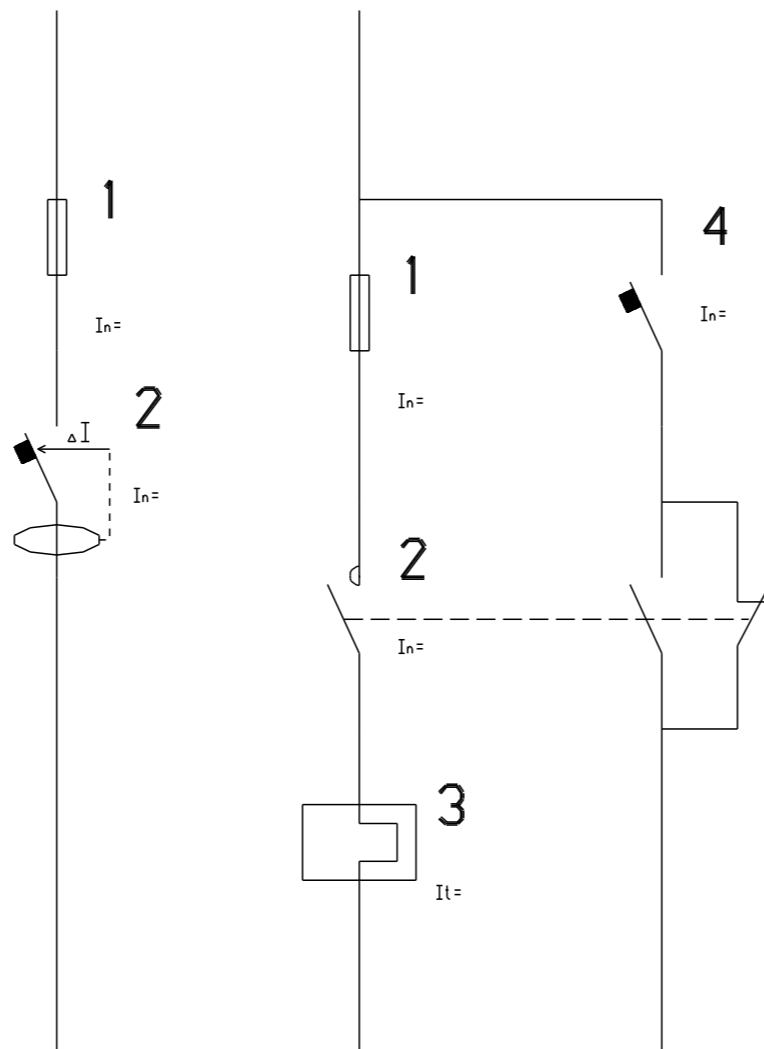

FUKMFA\QF - 2 MODULY

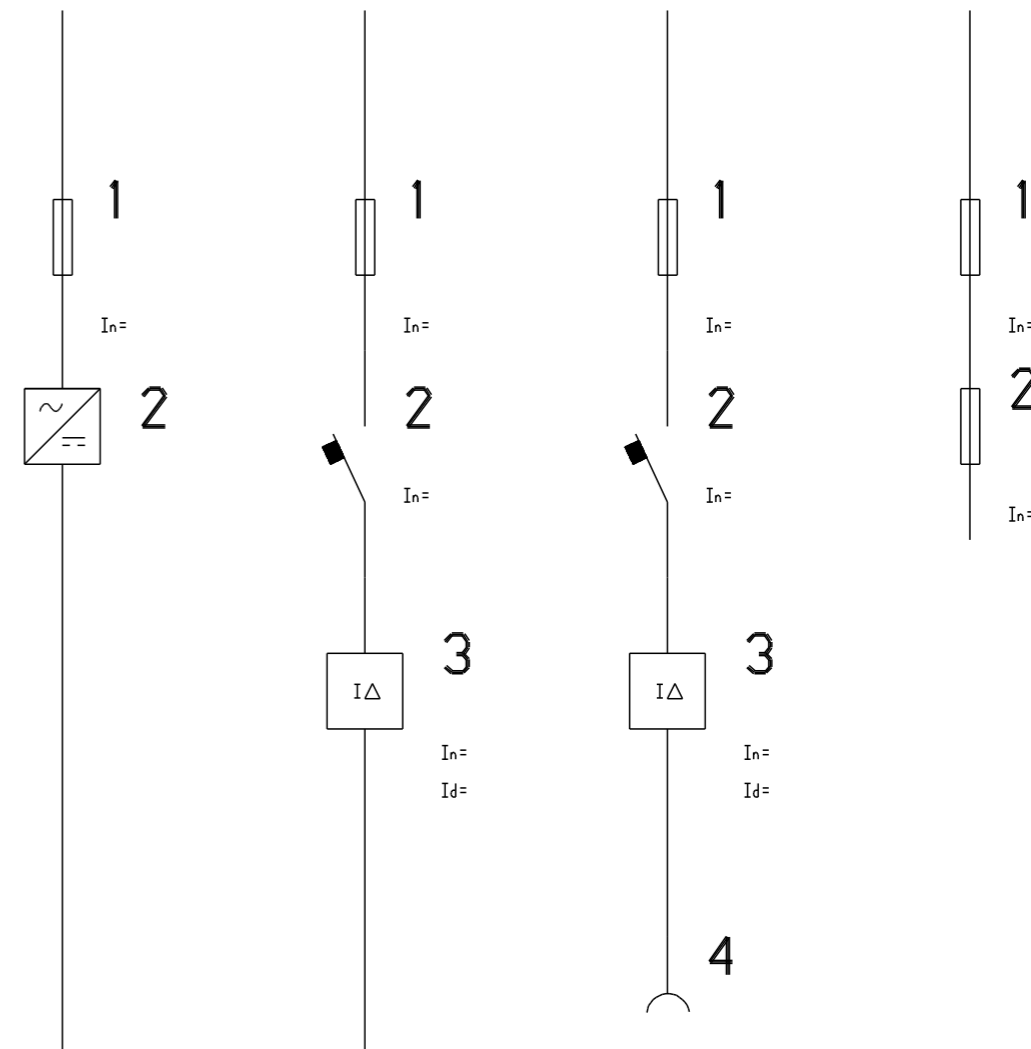

FUNGFA

FUFAKM2

FUTFU\Z

FUNG

FUX

FUQFFI

PRFUS<QM>RA\FUS

FUQM\QMOB

FUQFQMKa

FUQFKA

FUNGFA

FUFAKM2

FUTFU\Z

FUNG

FUX

FUQFFI

PRFUS<QM>RA\FUSOF

FUQM\QMOB

FUQFQMKa

FUQFKA

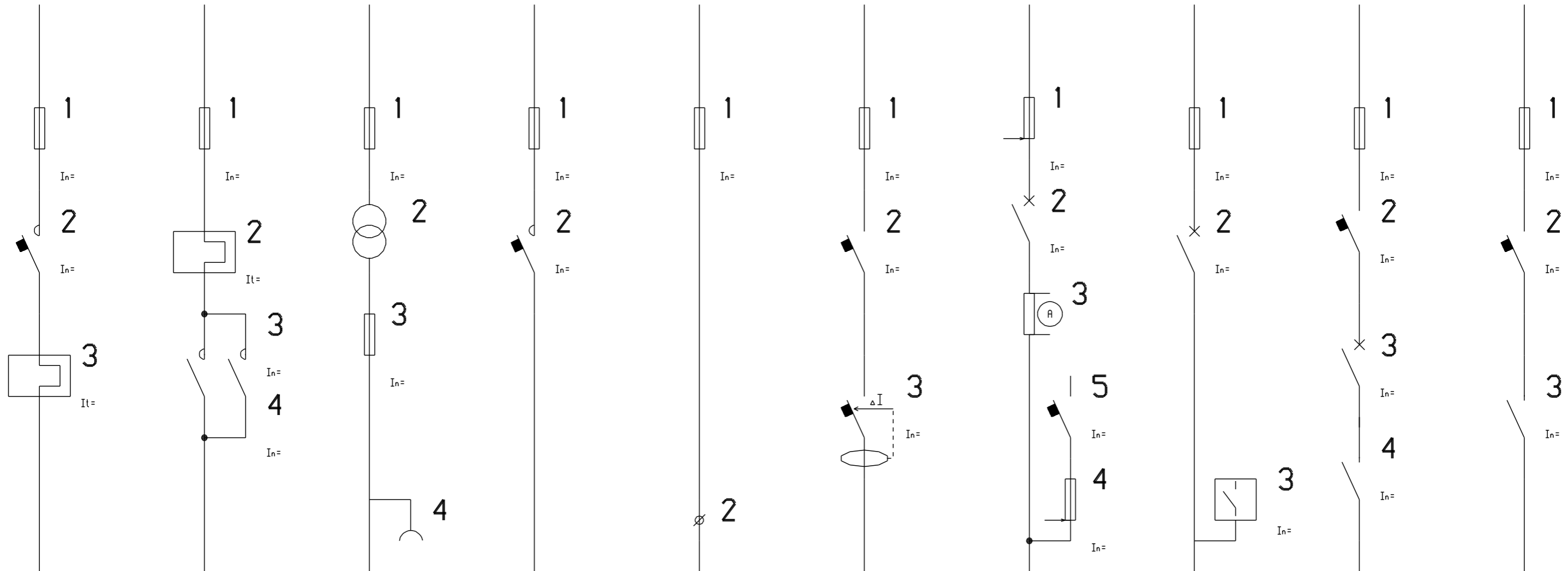

FUSQFKMX

FUSQFKMX

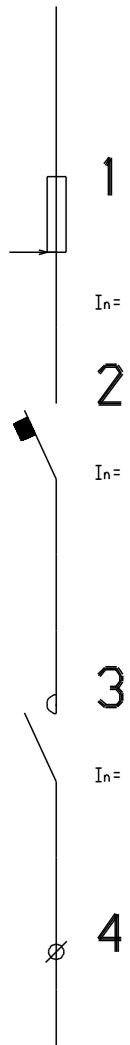

FUFAKM

FUFAKM

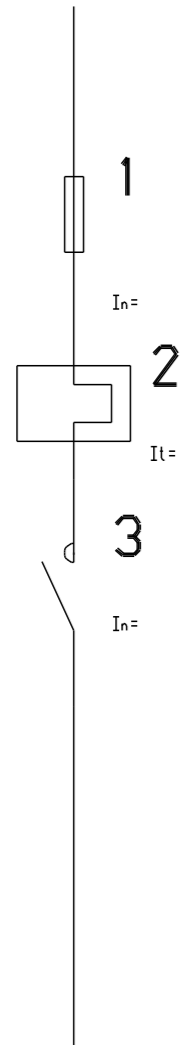

FUQF\QF

FUQF\QF

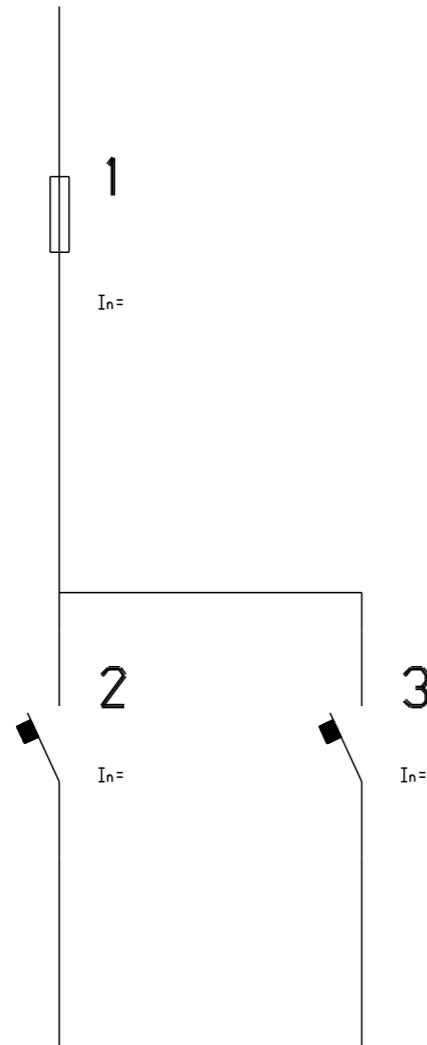

FUFAKMX\FA

FUFAKMX\FA

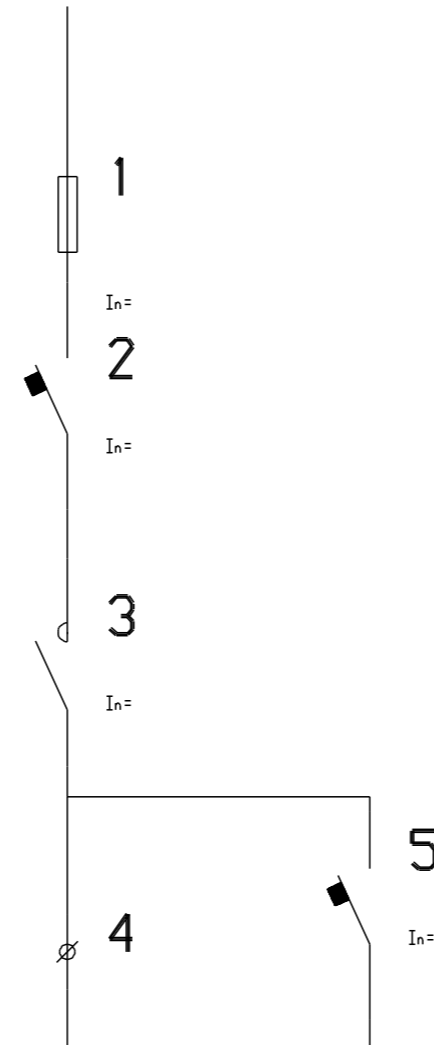

FUKMFAX

FUKMFAX

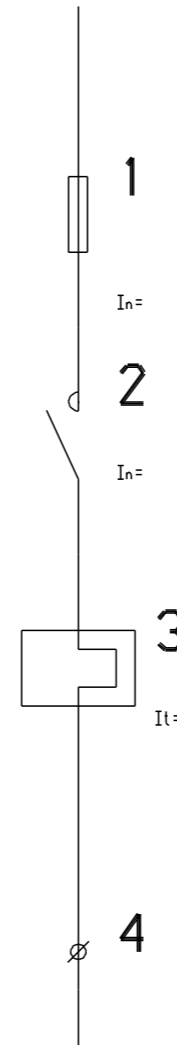

FUKMFA\FA

FUKMFA\FA

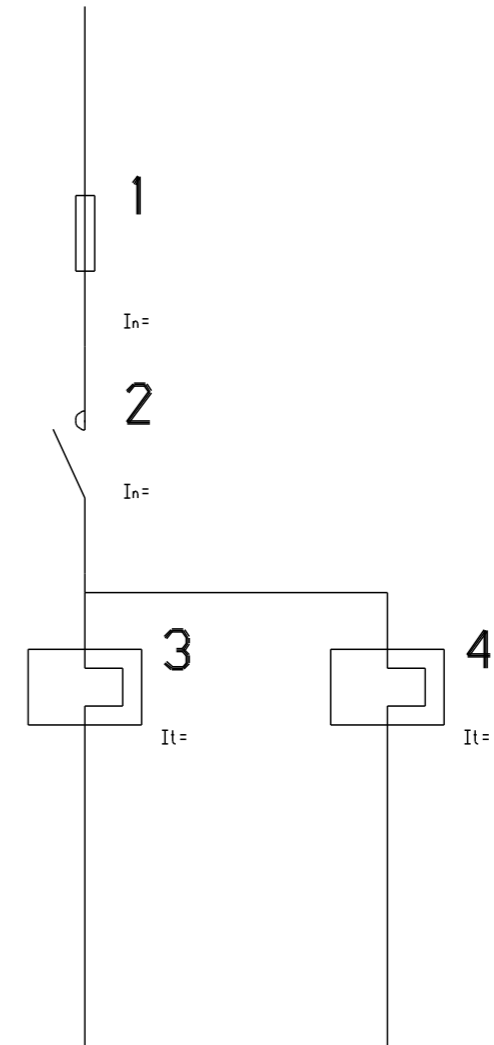

FUKMFAQF

FUKMFAQF

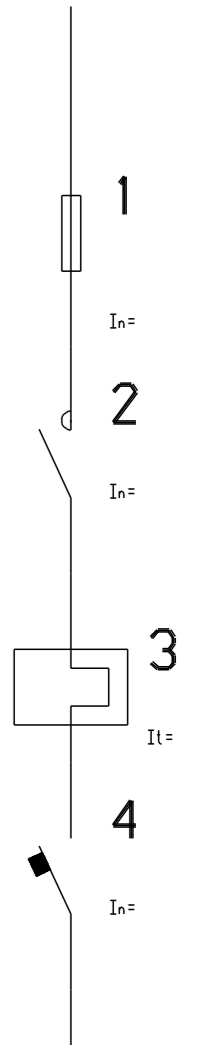

FUKMFA\FA - 2 MODULY

FUKMFA\FA - 2 MODULY

FUKMFA\FA - 2 MODULY

FUSQF\QF
FUSQF\QF

FU4QM4NOTREP4
FU4QM4NOTREP4

FUQMNOTREP
FUQMNOTREP

FUKM\QF
FUKM\QF

FUQFOVL
FUQFOVL

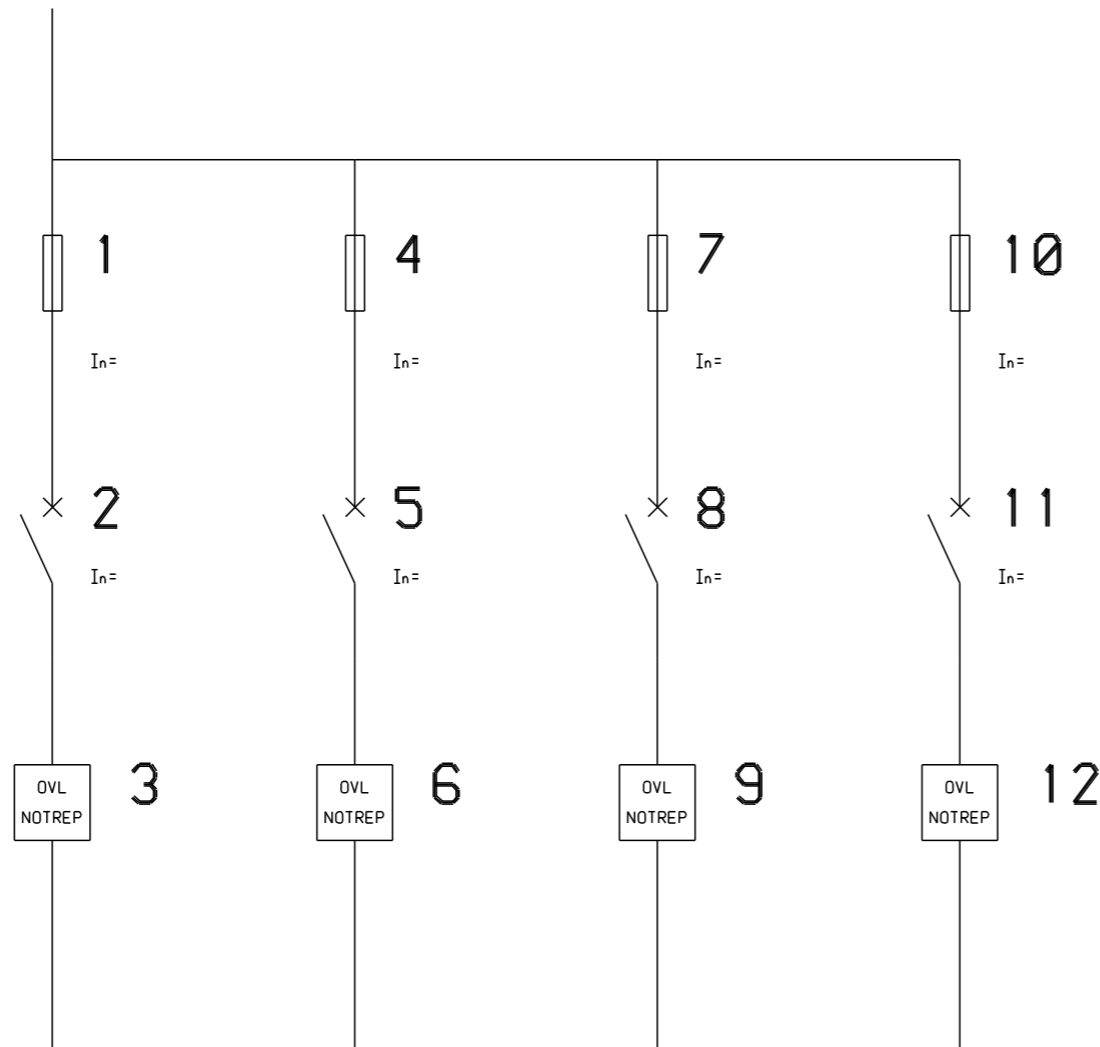
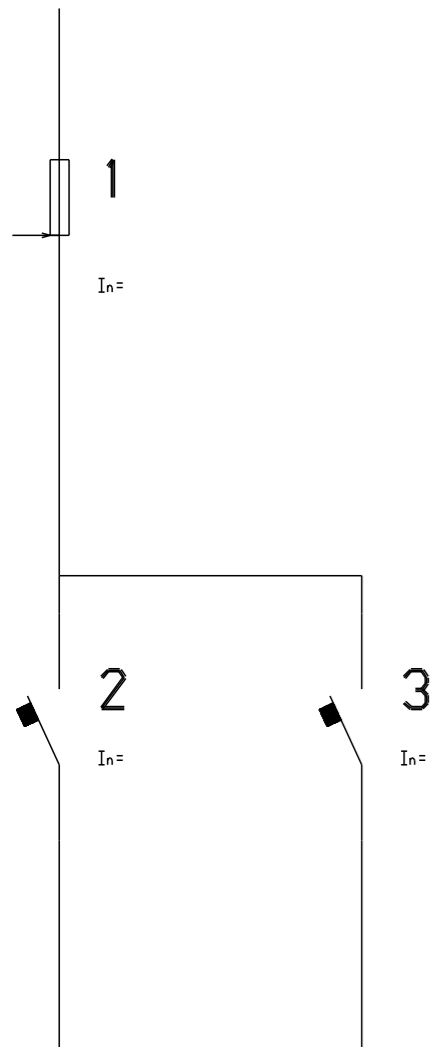

FU4QM4NOTREP4 - 4 MODULY

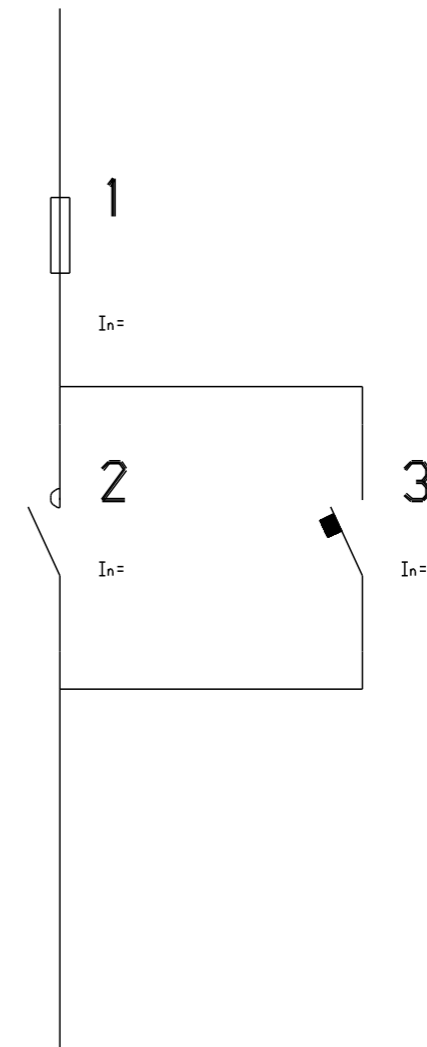
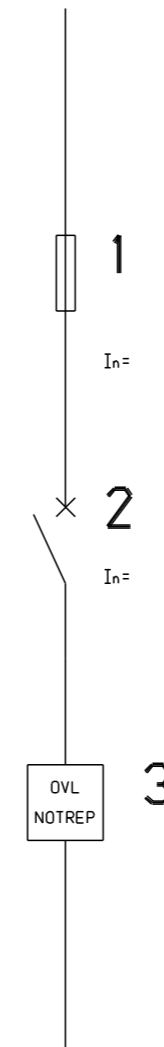

FUKM\QF - 2 MODULY

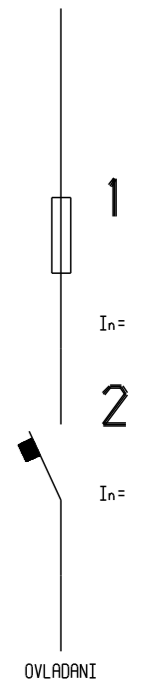

FUQFKMX\QFX
FUQFKMX\QFX

PRTAQF\QSF\QSF\
PRTAQF\QSF\QSF\QSF

FUNOTREP | FUS\QFOVL | FUTFU\FU
FUNOTREP FUS\QFOVL FUTFU\FU

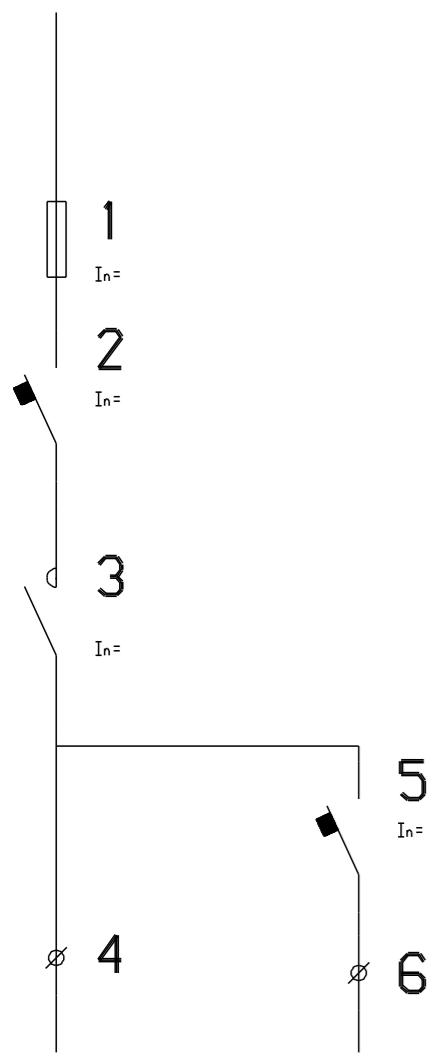

FUQFKMX\QFX - 2 MODULY

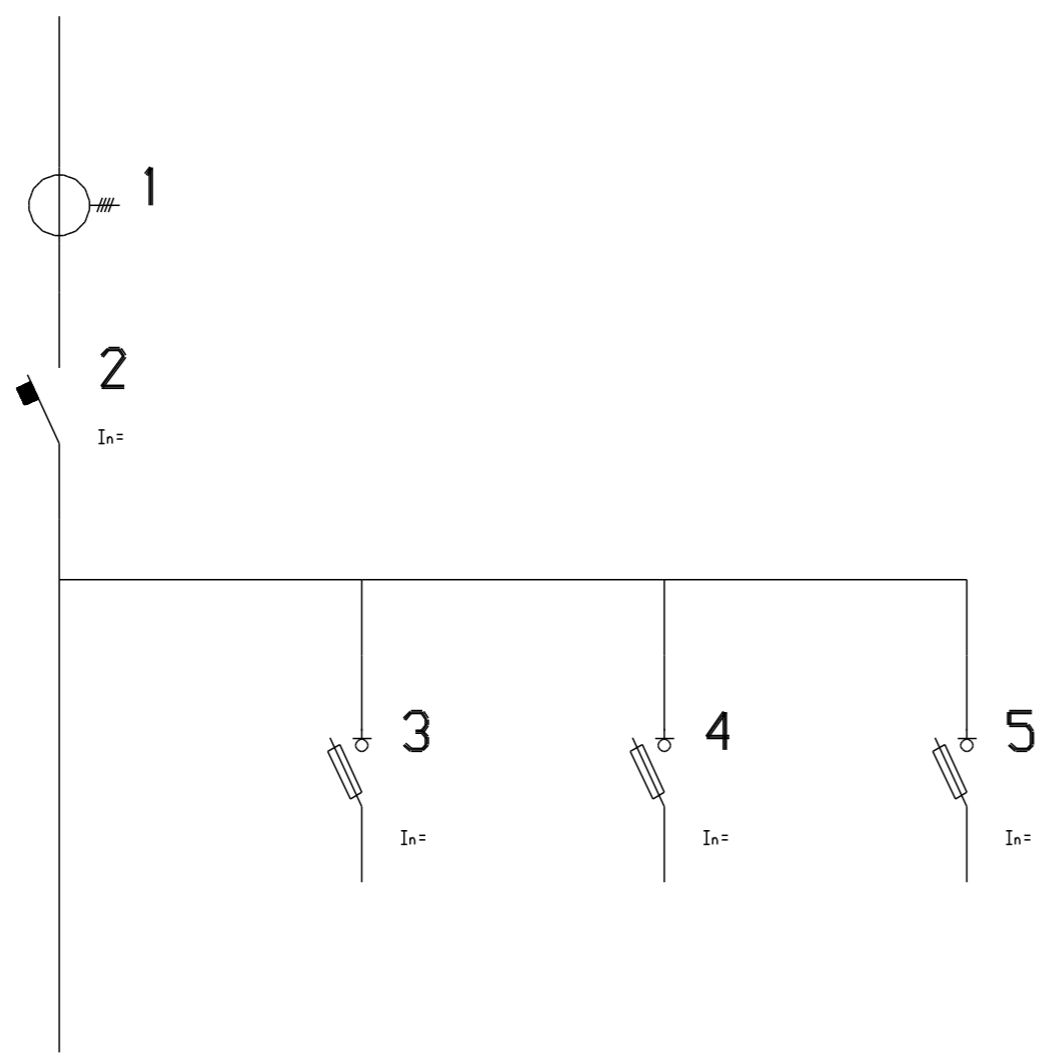

PRTAQF\QSF\QSF\QSF - 4 MODULY

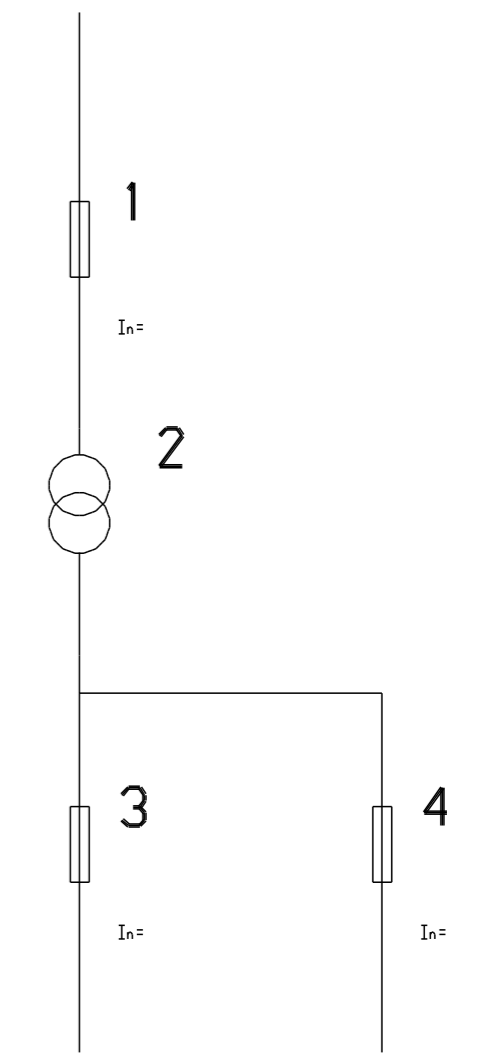
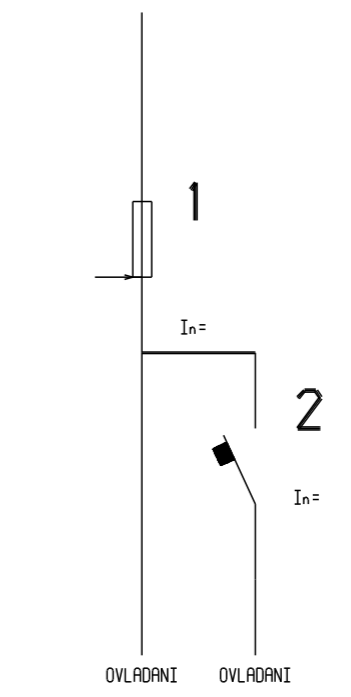
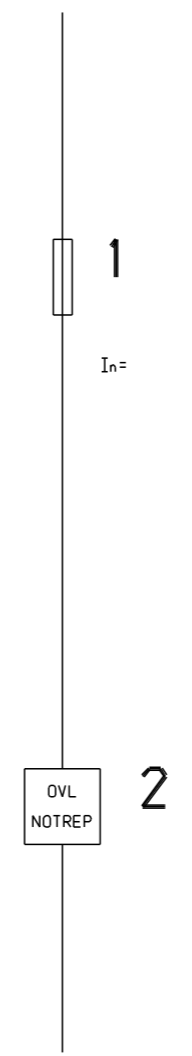

FUTFU\FU - 2 MODULY

FUQFX

|PRKM\QFFUS\FUS2

|PRKM\QF2FU_

|PRKM\FAFUS\FUS

|PRKM\PRERA\QFFUS|

PRKM\PREREFUS

FUQFX

PRKM\QFFUS\FUS2

PRKM\QF2FU_

PRKM\FAFUS\FUS2

PRKM\PRERA\QFFUS

PRKM\PREREFUS

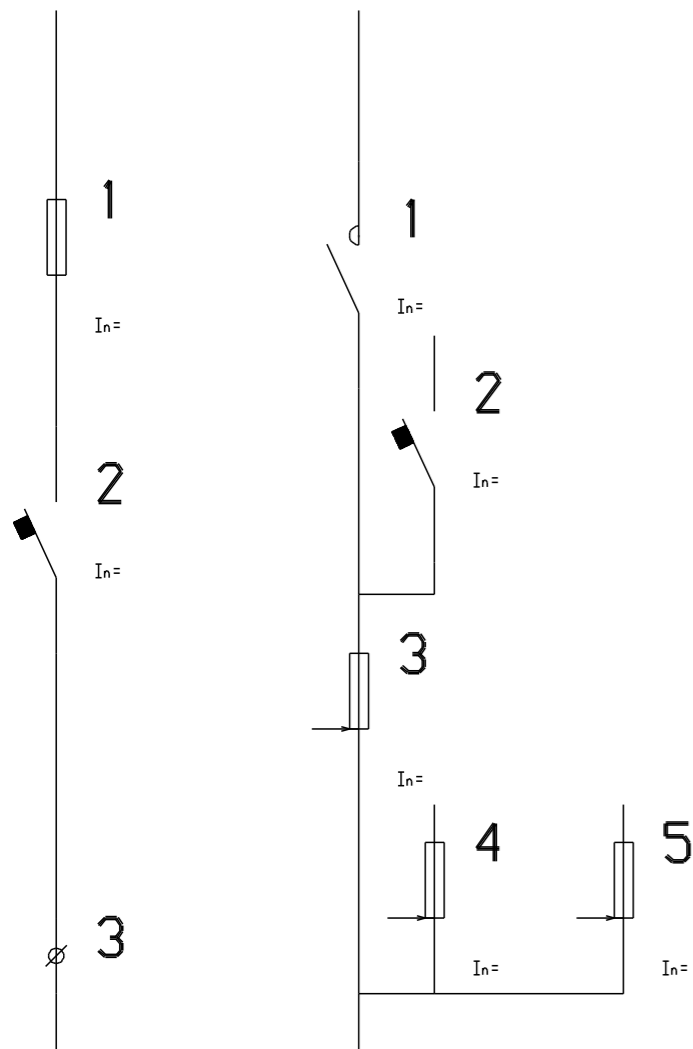

PRKM\QFFUS\FUS2 - 2 MODULY

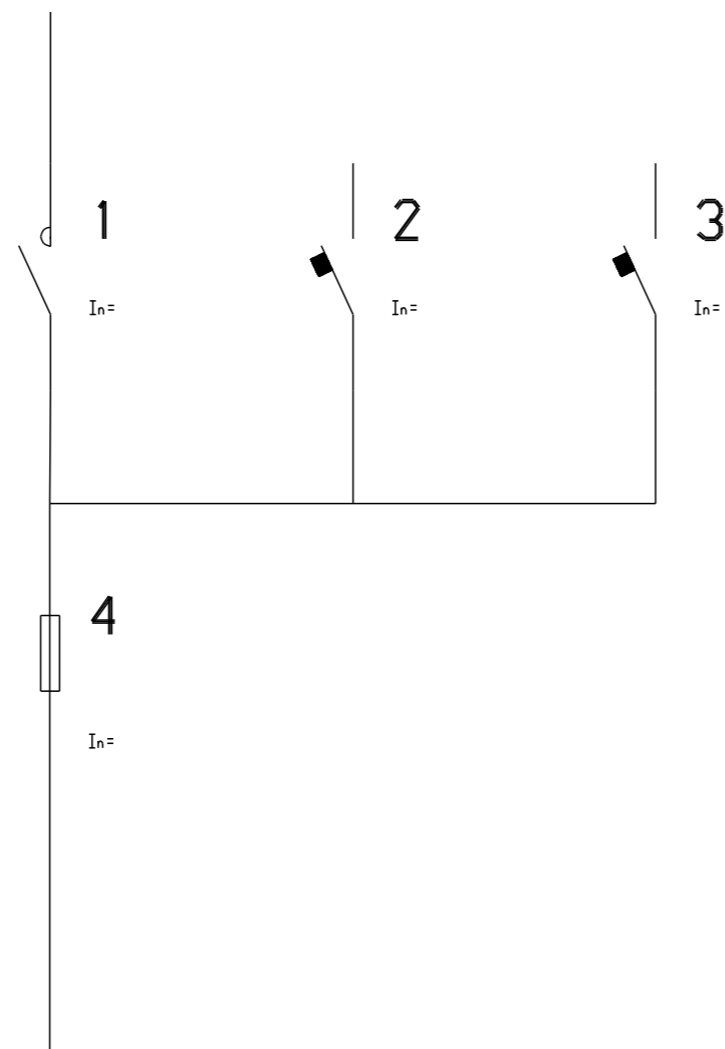

PRKM\QF2FU_ - 3 MODULY

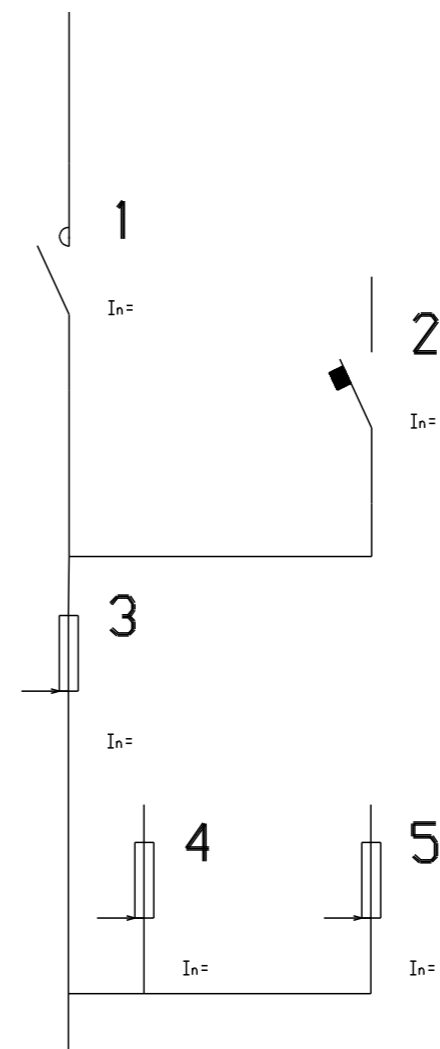

PRKM\FAFUS\FUS2 - 2 MODULY

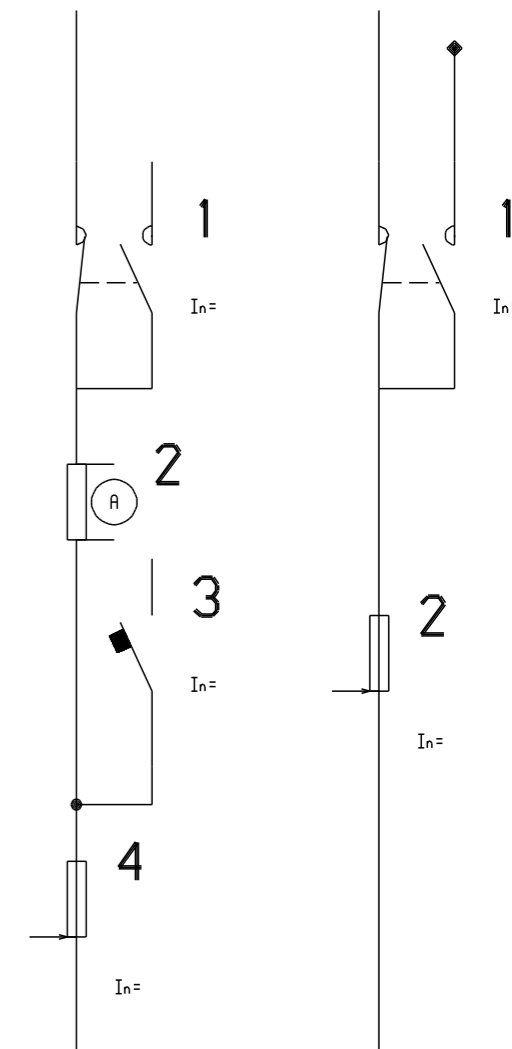

PRKMFU

PRKM\QM\QF2\FU

PRKM\QF2FU

PRKM\QM\QF2\FUS

KMFU

FAFU

PRKMFU

PRKM\QM\QF2\FU

PRKM\QF2FU

PRKM\QM\QF2\FUS

KMFU

FAFU

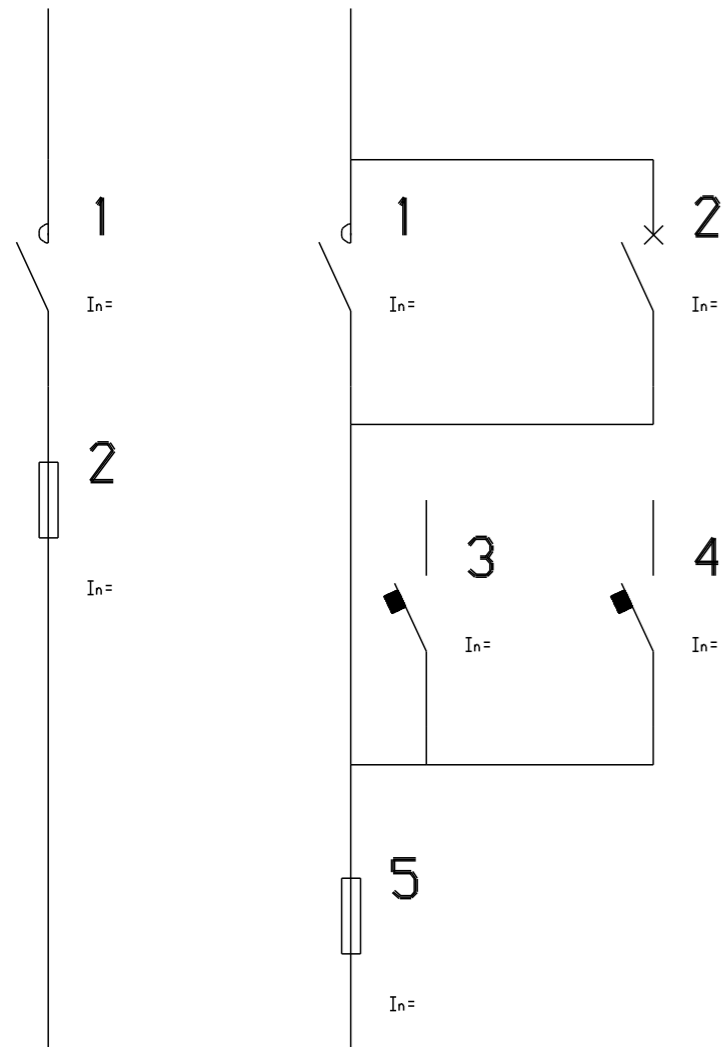

PRKM\QM\QF2\FU - 2 MODULY

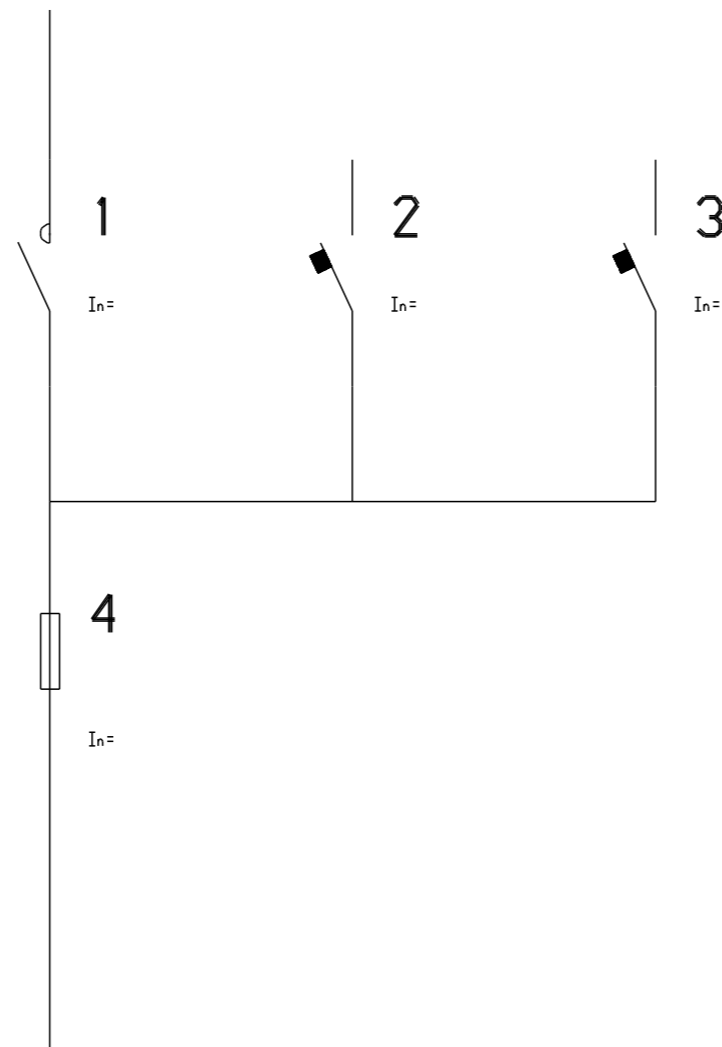

PRKM\QF2FU - 3 MODULY

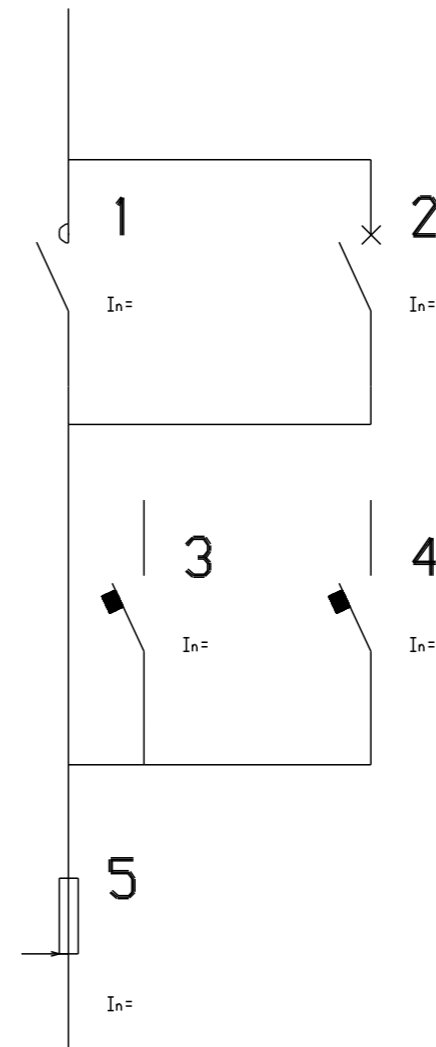

PRKM\QM\QF2\FUS - 2 MODULY

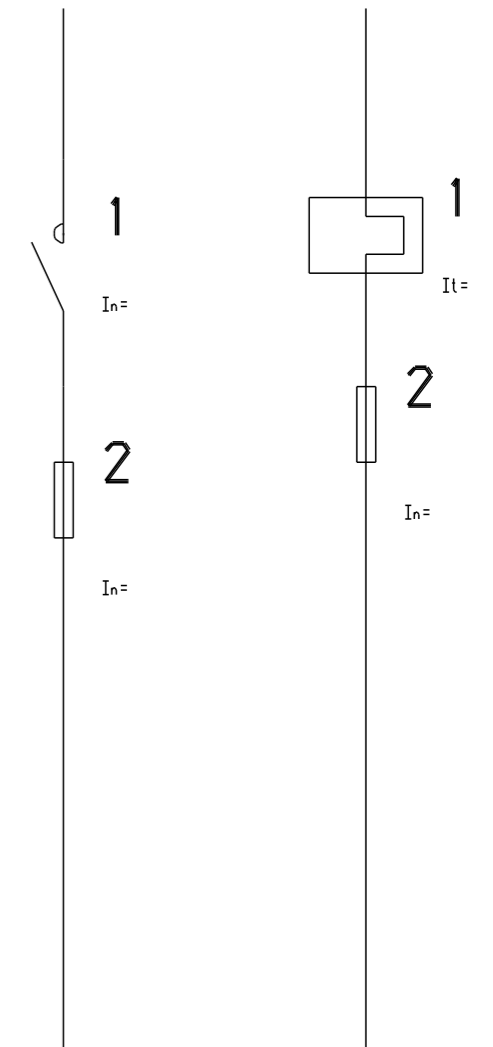

PRKMFU\QF2

PRKMOMFU\FU\FUQ

PRKMFU\FU\FV

PRKMFU\FU

PRKMFU\FU1

PRKM\FUFU

PRKMFU\QF2

PRKMOMFU\FU\FUQMZ

PRKMFU\FU\FV

PRKMFU\FU

PRKMFU\FU1

PRKM\FUFU

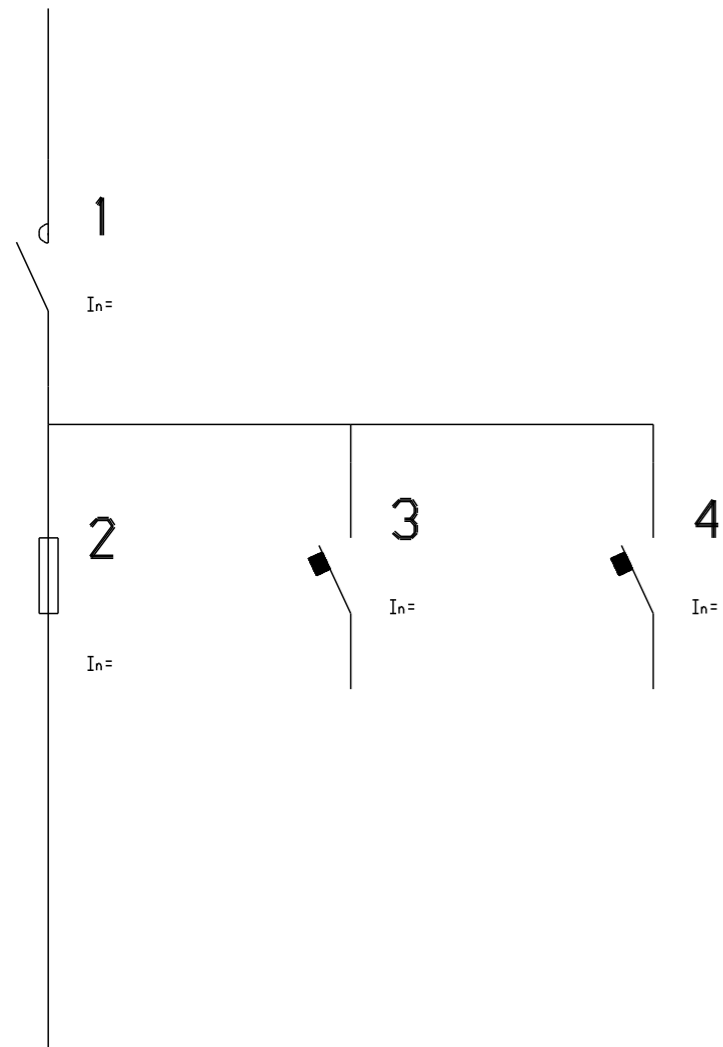

PRKMFU\QF2 - 3 MODULY

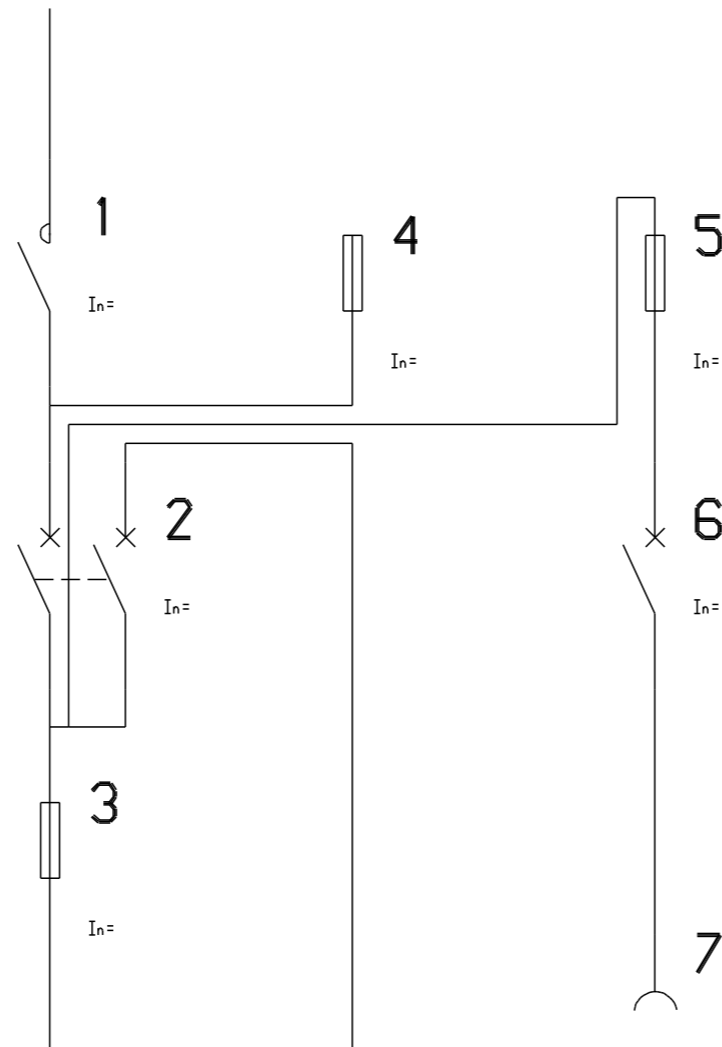

PRKMOMFU\FU\FUQMZ - 3 MODULY

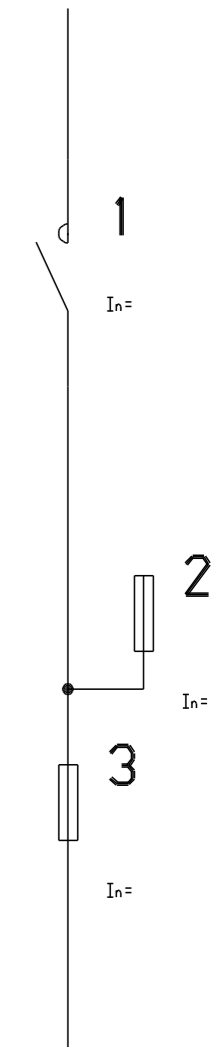
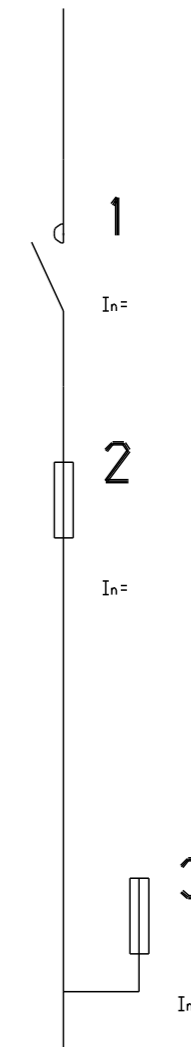
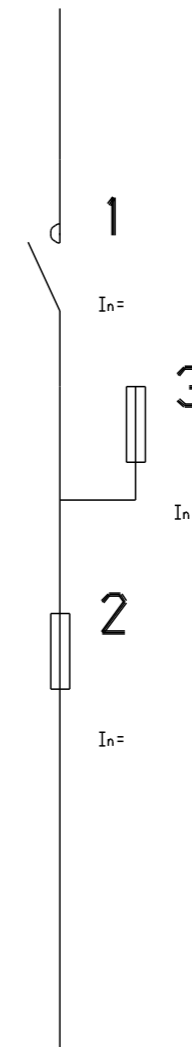
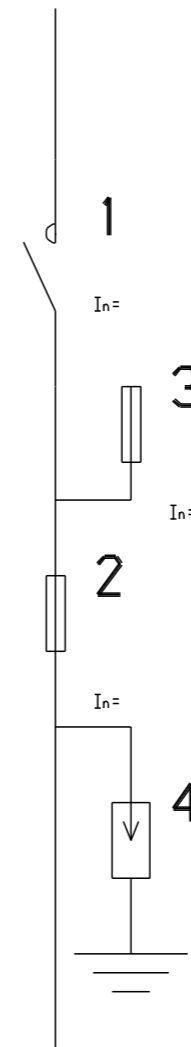

PRKM\OFFUS

RFUS

PRKM\PRERAFUS

FUSQMRA

FUZV

PRKMFU\KM\KM

FUSQS

FUSQSRA

FUPV

PRKM\OFFUS

RFUS

PRKM\PRERAFUS

FUSQMRA

FUSQMRA

PRKMFU\KM\KM

FUSOS

FUSOSRA

FUPV

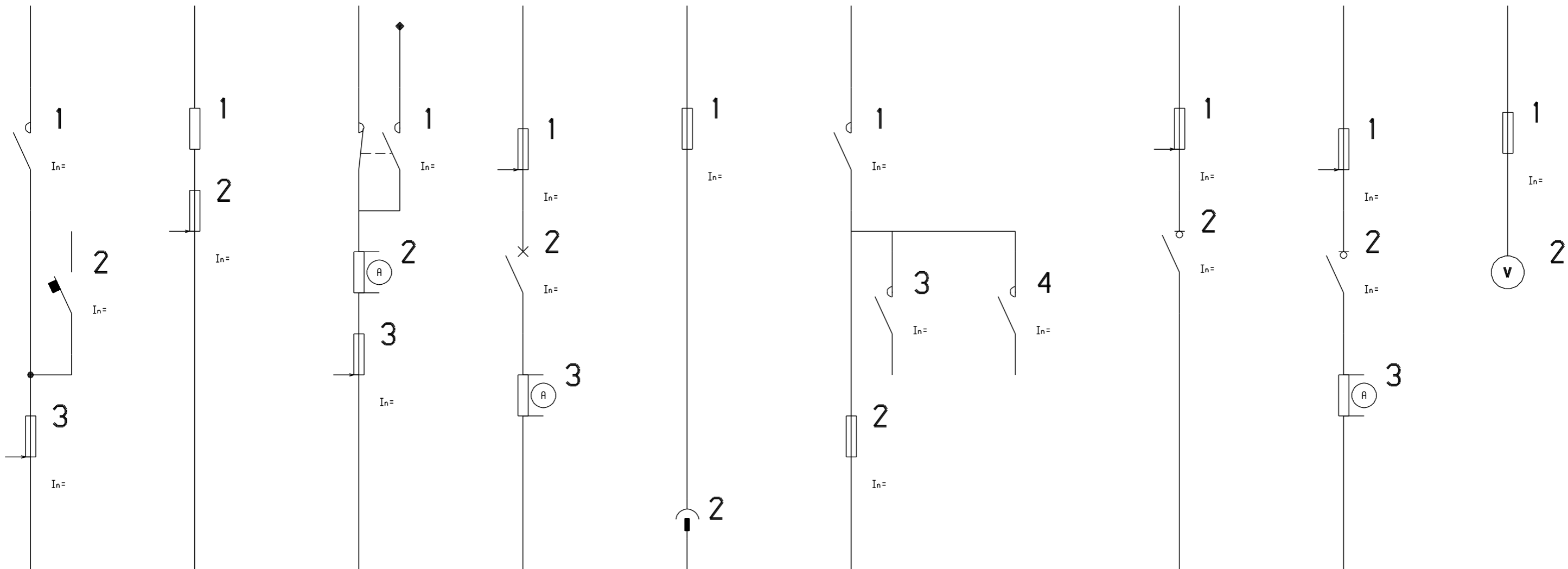

PRKMFU\KM\KM - 2 MODULY

FU\FU

FUKA\KA

FUREG\

FUKA2

PRFUQF\QF

FUSQPKM

FU\FU

FUKA\KA

FUREG

FUKA2

PRFUQF\QF

FUSQPKM

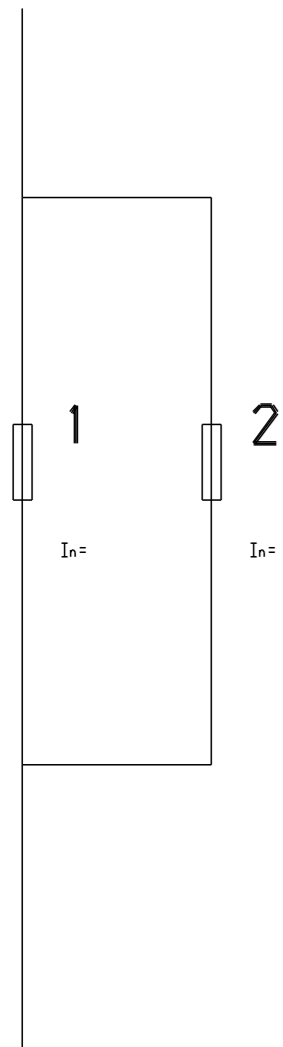

FU\FU - 2 MODULY

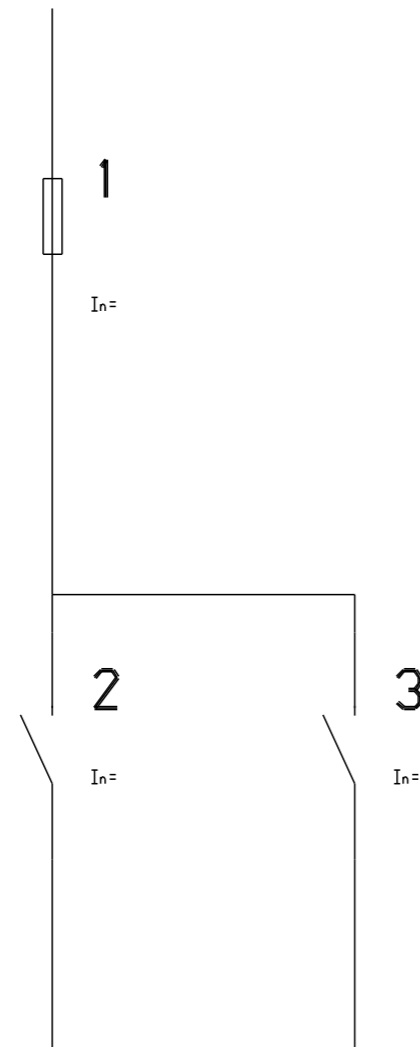

FUKA\KA - 2 MODULY

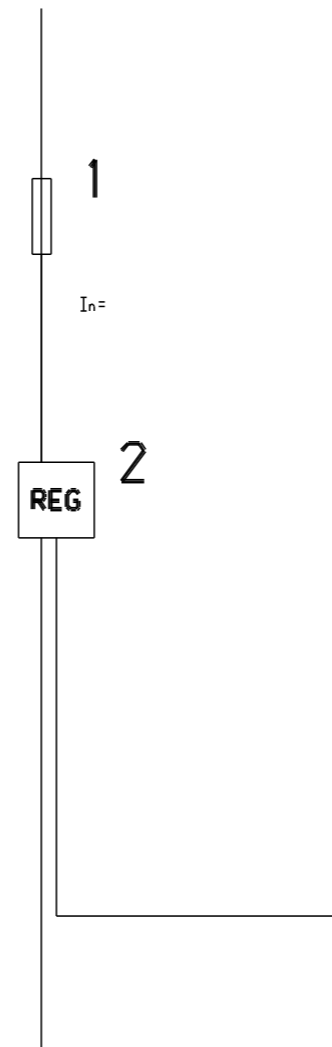

FUREG - 2 MODULY

