

KMFAX

KMFAX

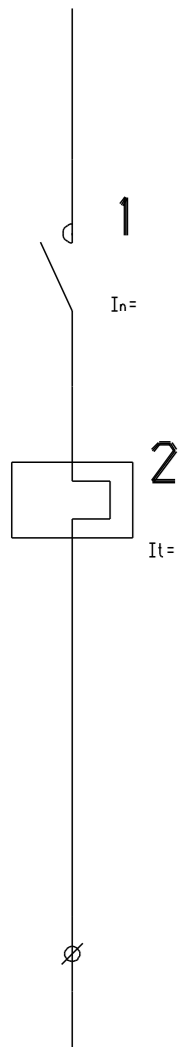

KMTA

KMTA

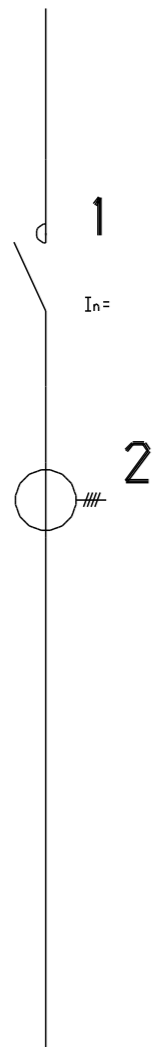

R

R



<_>\Q\FV

<_>\Q\FV

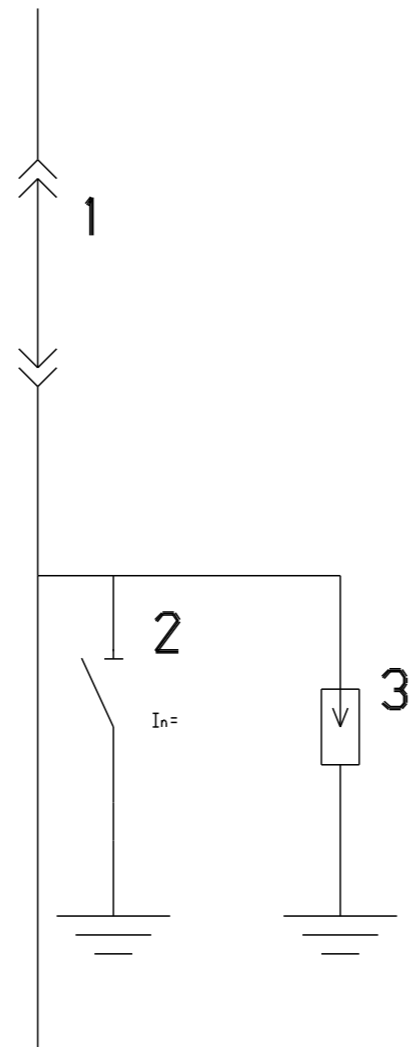

<_>\Q\FV - 2 MODULY

\<TVVQ\FV

\<TVVQ\FV

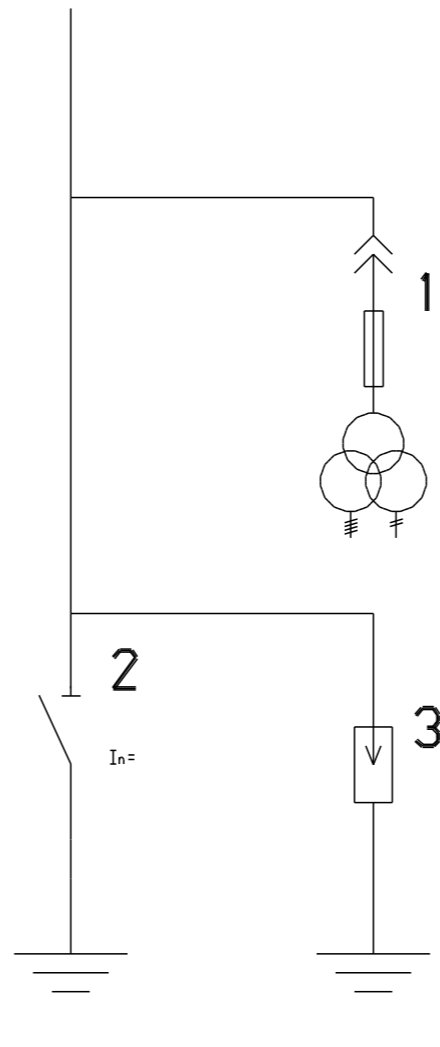

\<TVVQ\FV - 2 MODULY

PRTA1

PRTA1

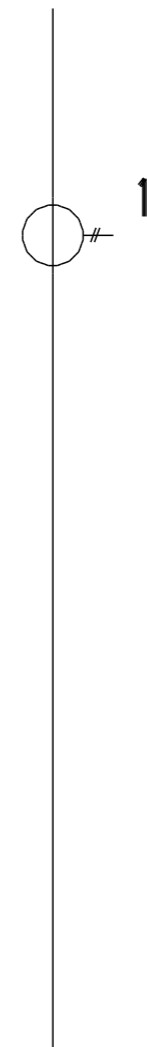

<>

<>



PE

PE



KMFAN

PRW

KAKAKA

T

PRVDQS

VD1

PRVD

PRPA\FU

PRPA

RA

KMFAN

PRW

KAKAKA

T

PRVDQS

VD1

PRVD

PRPA\FU

PRPA

RA

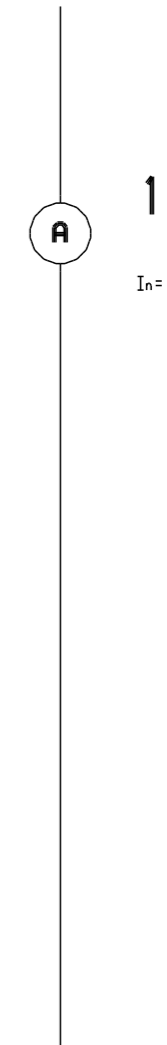
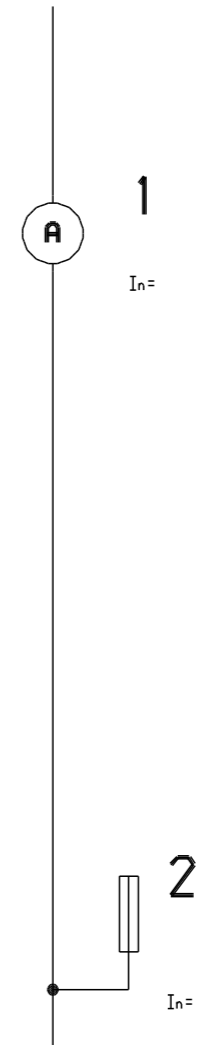
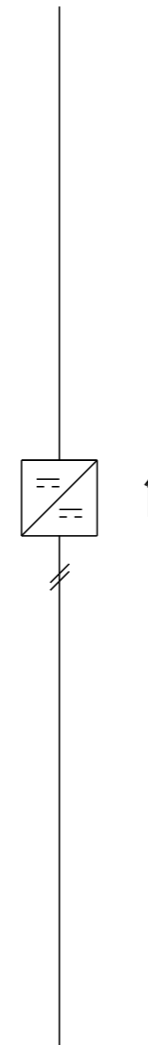
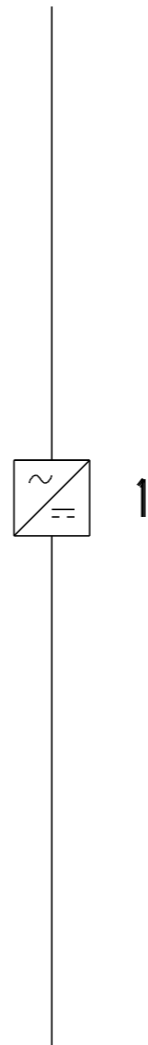
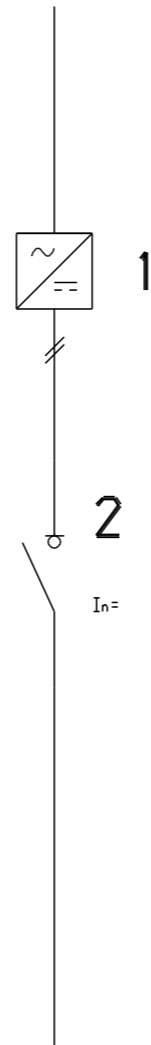
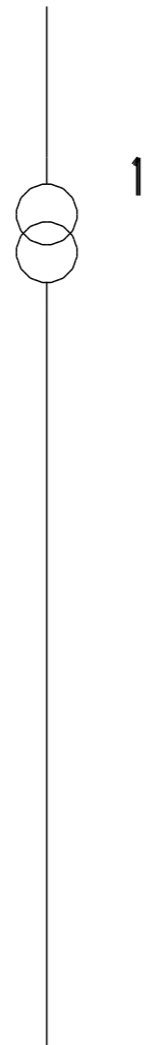
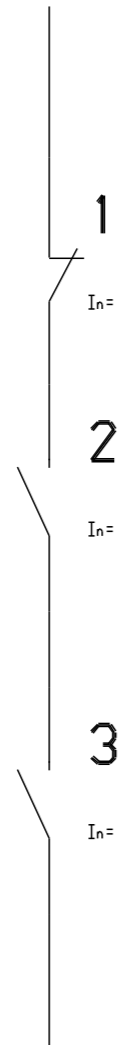
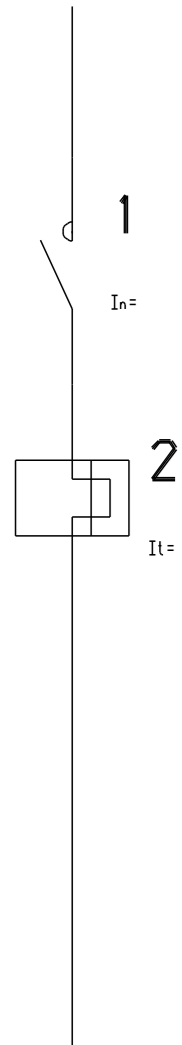

PRRA

TABT

PRKM

PRKM\FU

KA

FV

FA

PR<_>

PRRA\FUS

TA1

PRRA

TABT

PRKM

PRKM\FU

KA

FV

FA

PR<_>

PRRA\FUS

TA1

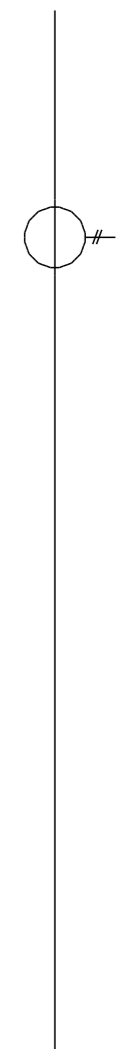
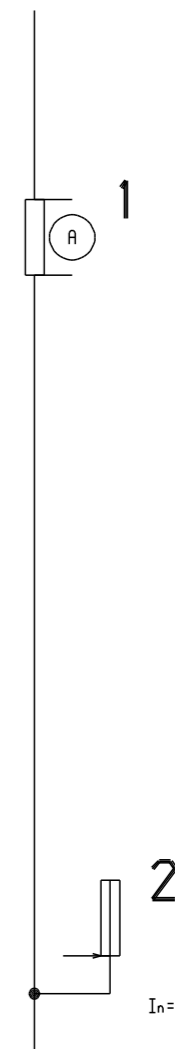
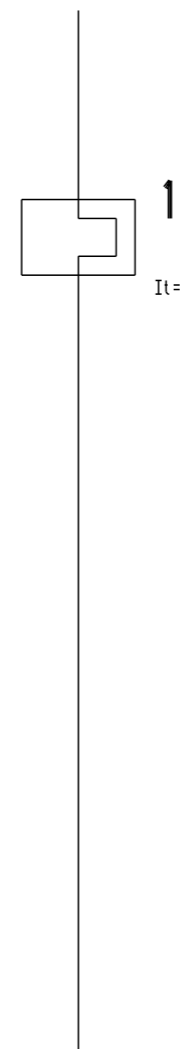
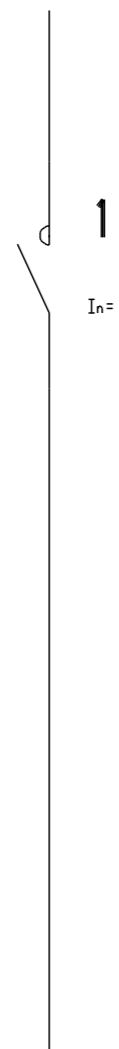
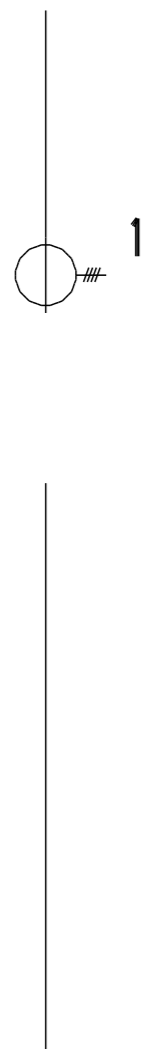
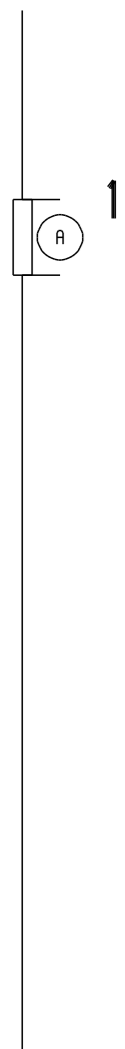

PR<TAATVV>

<TVV2

HOLA

PR<TATVVA>

<TV2

KM

Z

PRWX

PRRAX

PR<TAATVV>

<TVV2

HOLA

PR<TATVVA>

<TV2

KM

Z

PRWX

PRRAX

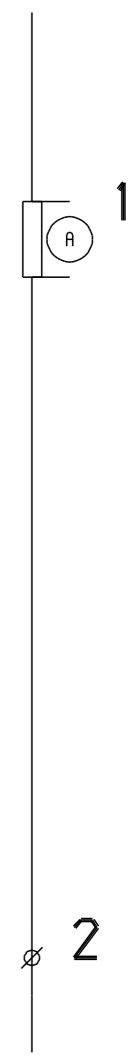
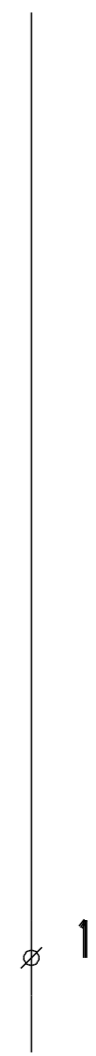
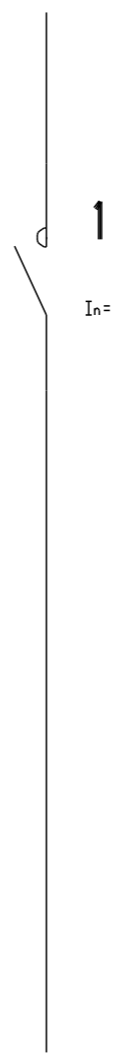
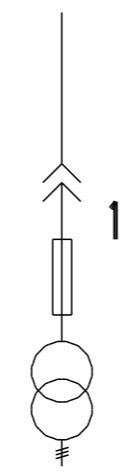
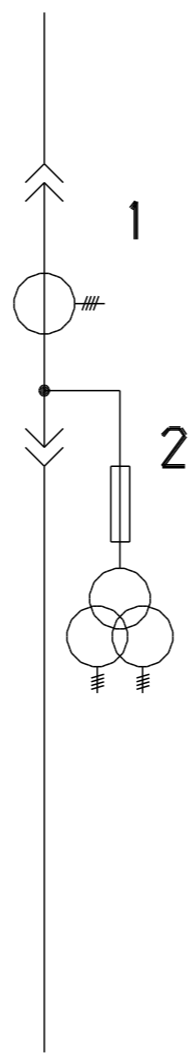
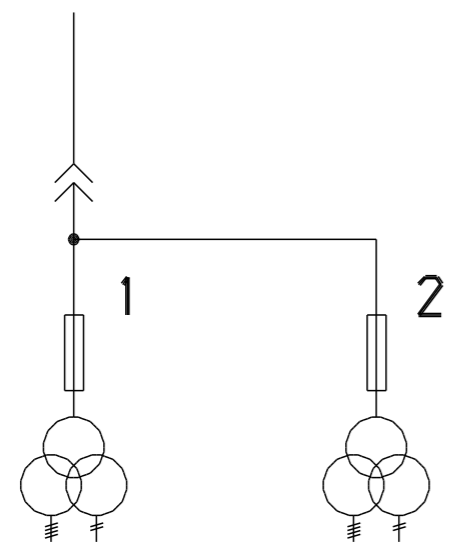
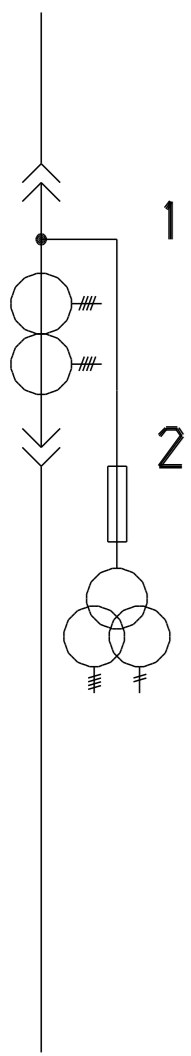

<TVV2 - 2 MODULY

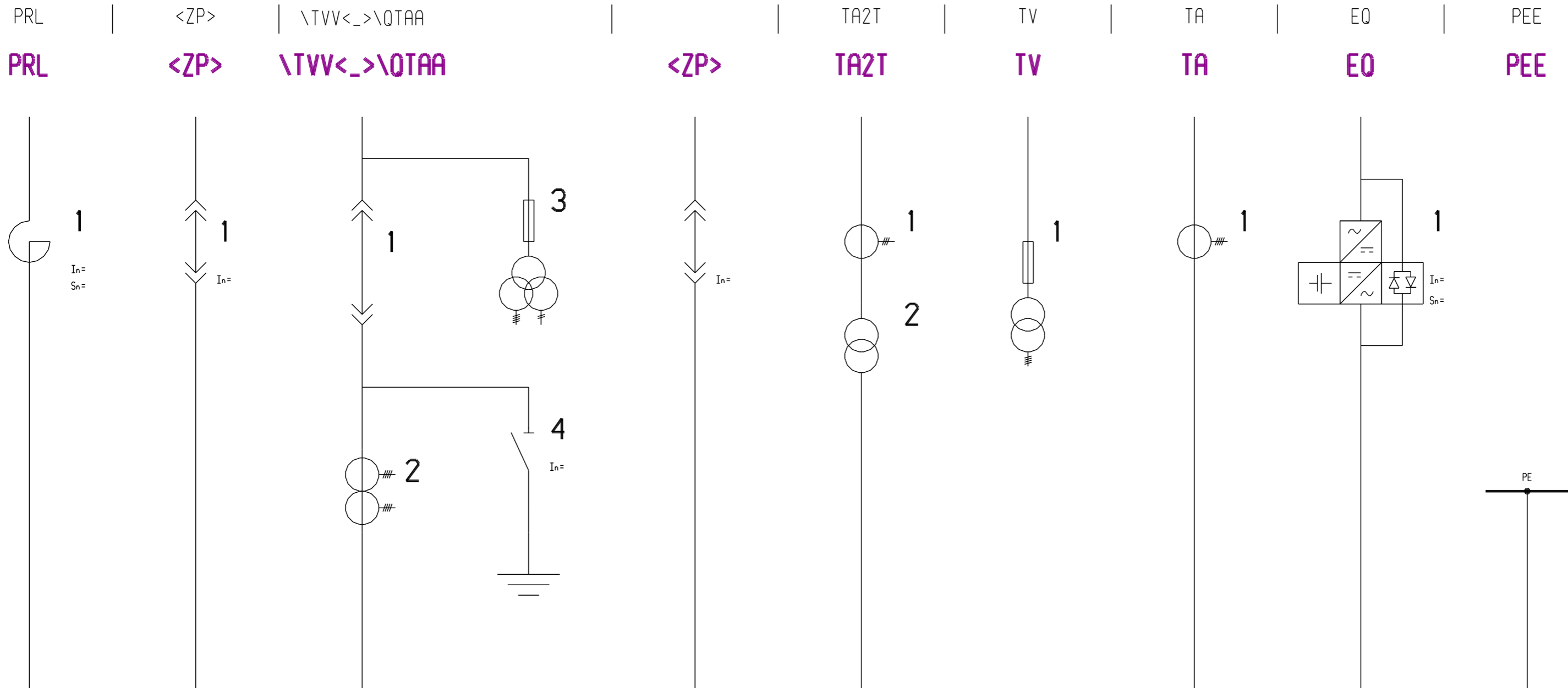

KMFA

PRRA\FU

UP

WUF

PRRARA

RARA

ND

D

PRTAA<TAATVV>

TATA1

KMFA

PRRA\FU

UP

WUF

PRRARA

RARA

ND

D

PRTAA<TAATVV>

TATA1

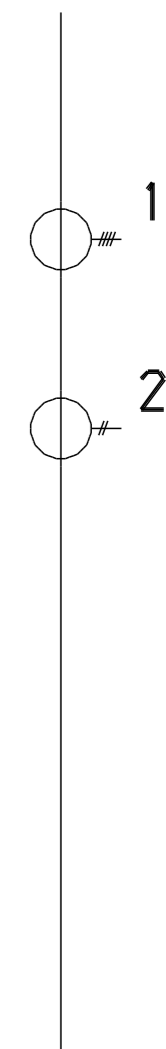
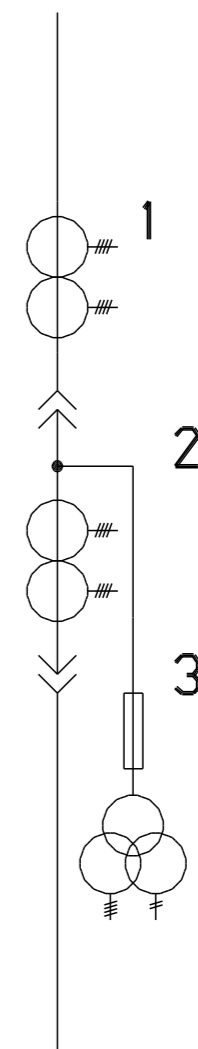
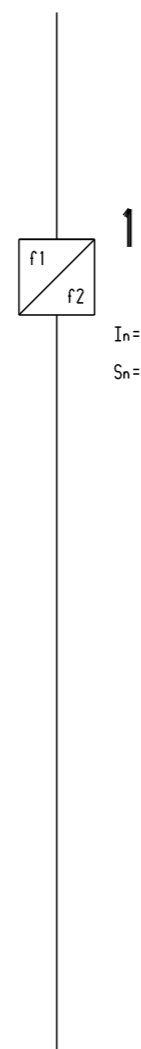
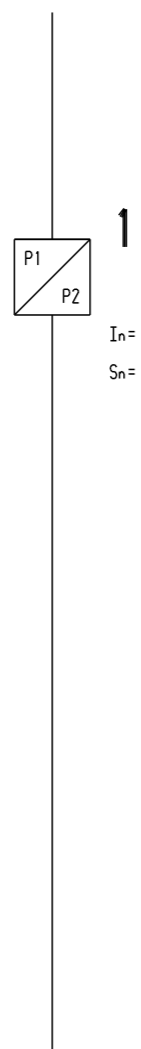
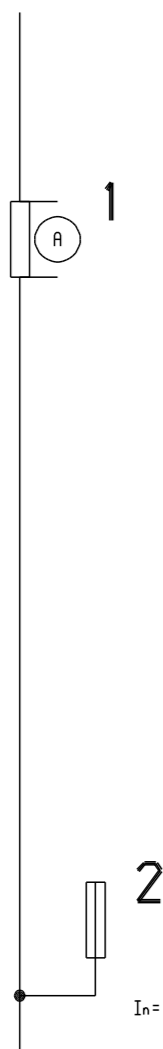
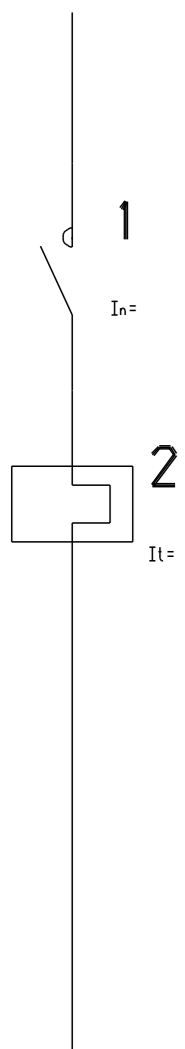

<_>\TVV\QTAA

<_>\TVV\QTAA

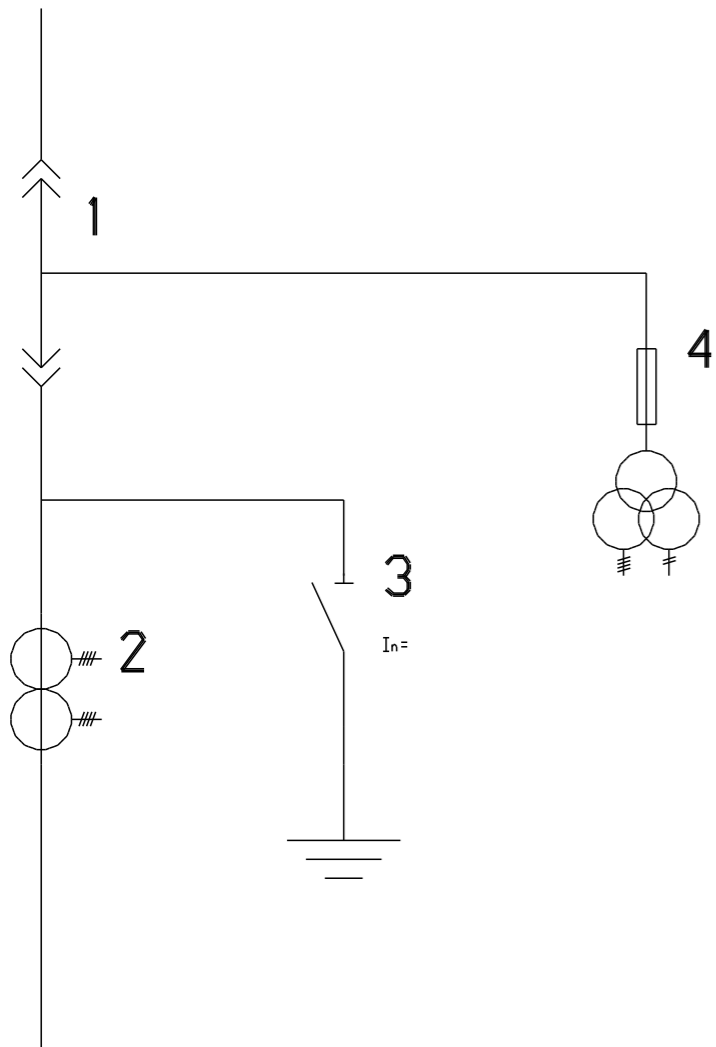

<_>\TVV\QTAA 3 - MODULY

KMFANTA

KMFANTA

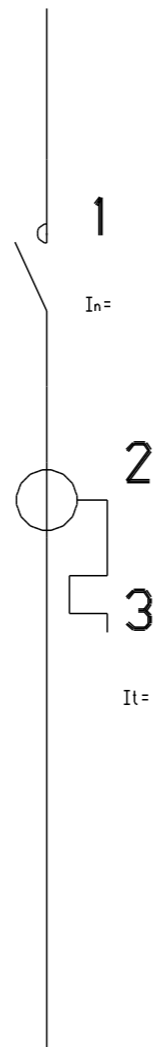

TVV

TVV

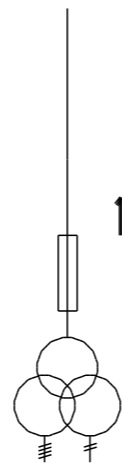

<_>TAA

<_>TAA

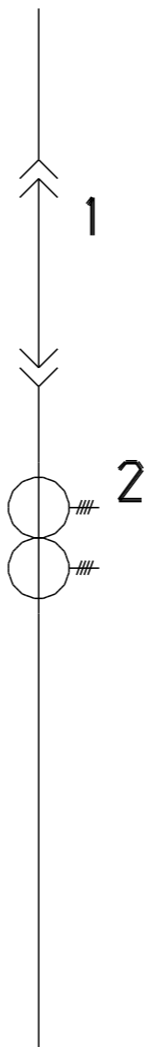

X

X



\TVV<_>TAA

\TVV<_>TAA

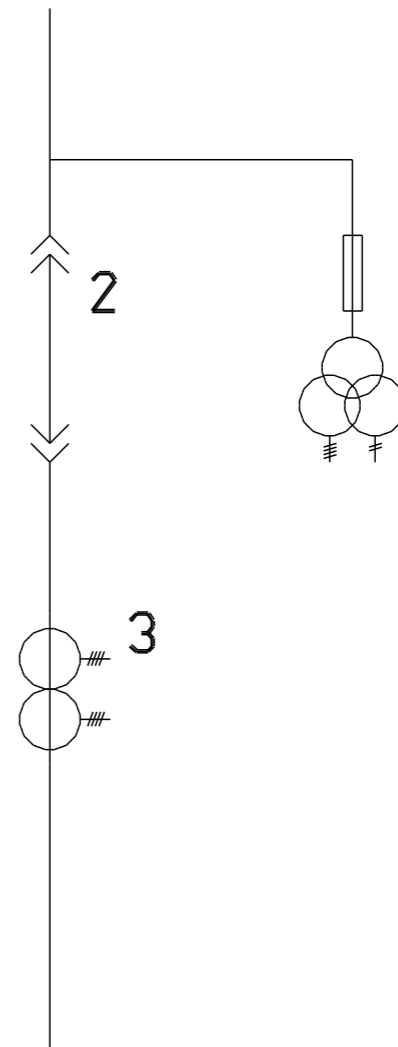

\TVV<_>TAA - 2 MODULY

PRTAA<TVV>

PRTAA<TVV>

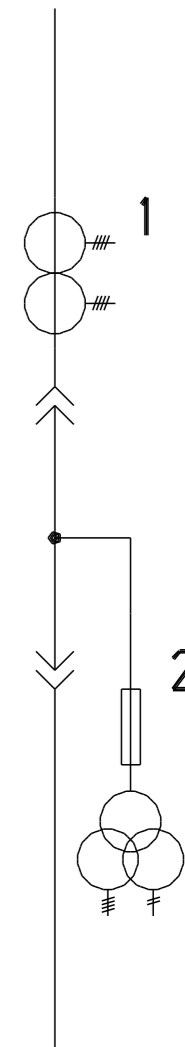

TA<QF>TA1 | PRW\R | PR<TATVVA>TA | PRR | PRRR | RR | QSFND2QF | PRT | PRPETA | <_>TA
TA<QF>TA1 | **PRW\R** | **PR<TATVVA>TA** | **PRR** | **PRRR** | **RR** | **OSFND2QF** | **PRT** | **PRPETA** | **<_>TA**

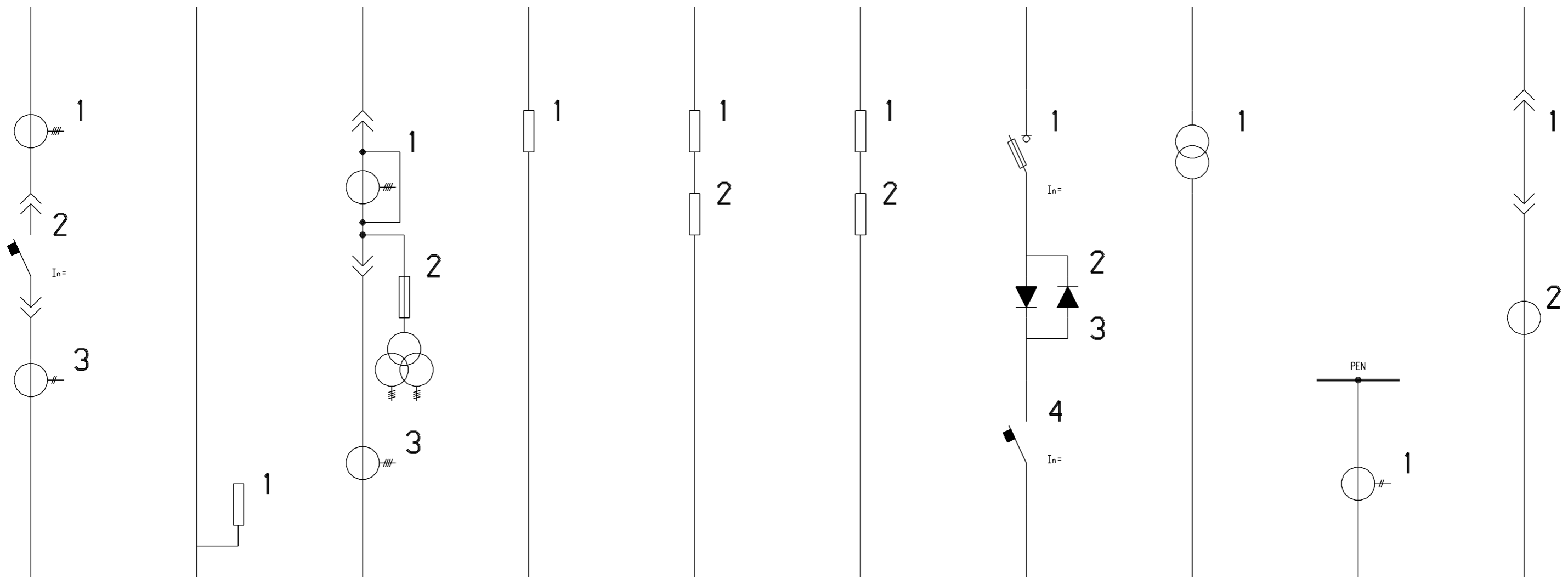

PRX

RX

PR<_>\TVV\QTAA

X5M

X4M

X3M

X2M

X1M

PRX

RX

PR<_>\TVV\QTAA

X5M

X4M

X3M

X2M

X1M

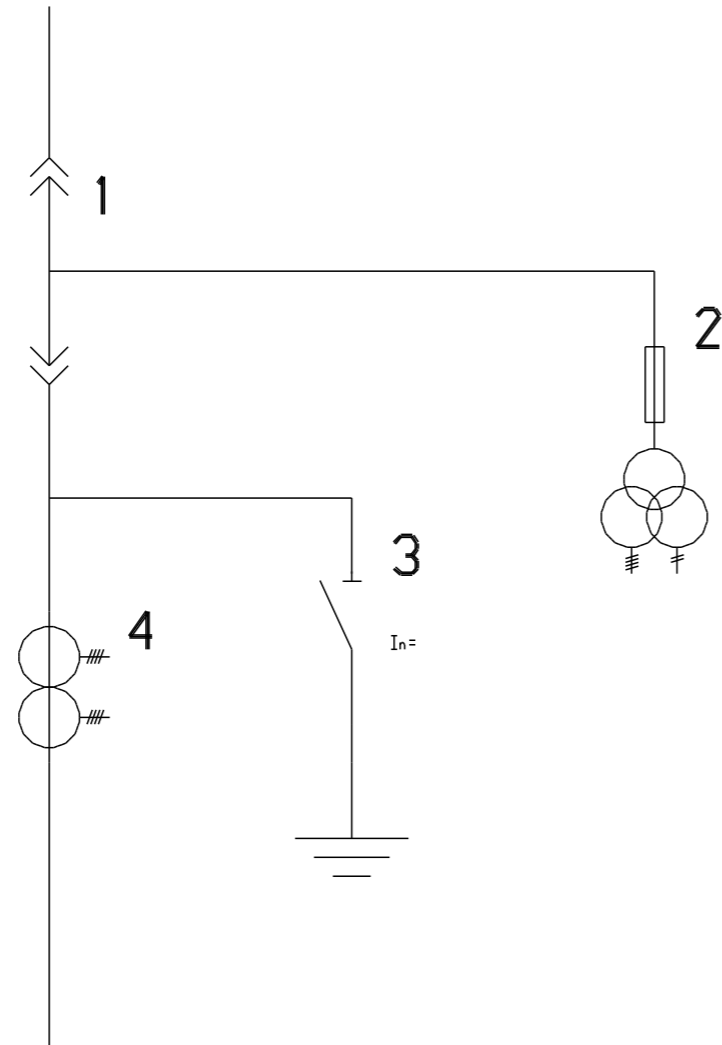
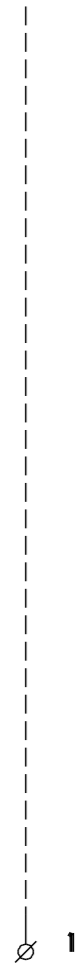

PR<_>\TVV\QTAA - 3 MODULY

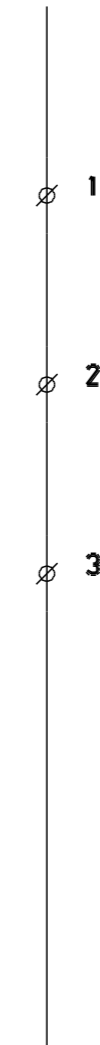
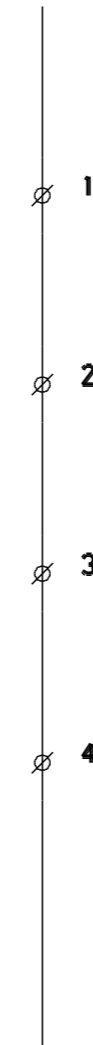

PR<_>\QTAA

PR<_>\QTAA

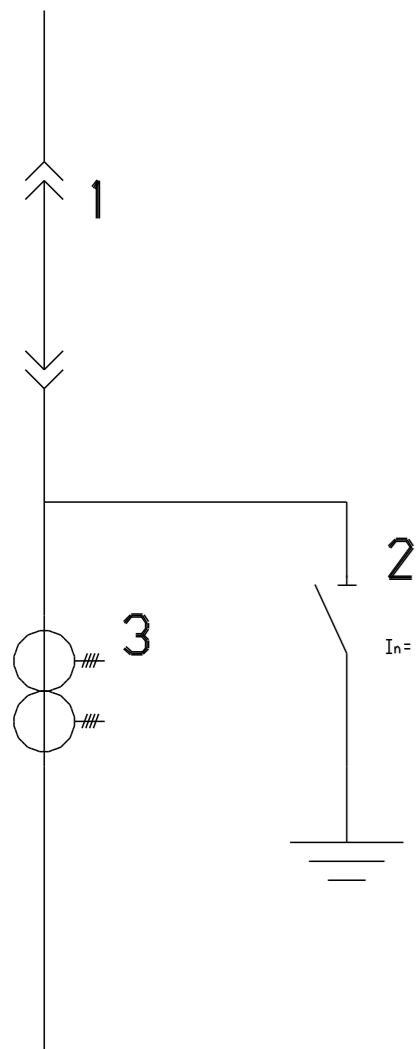

PR<_>\QTAA - 2 MODULY

PRT\FVL\FVN

PRT\FVL\FVN

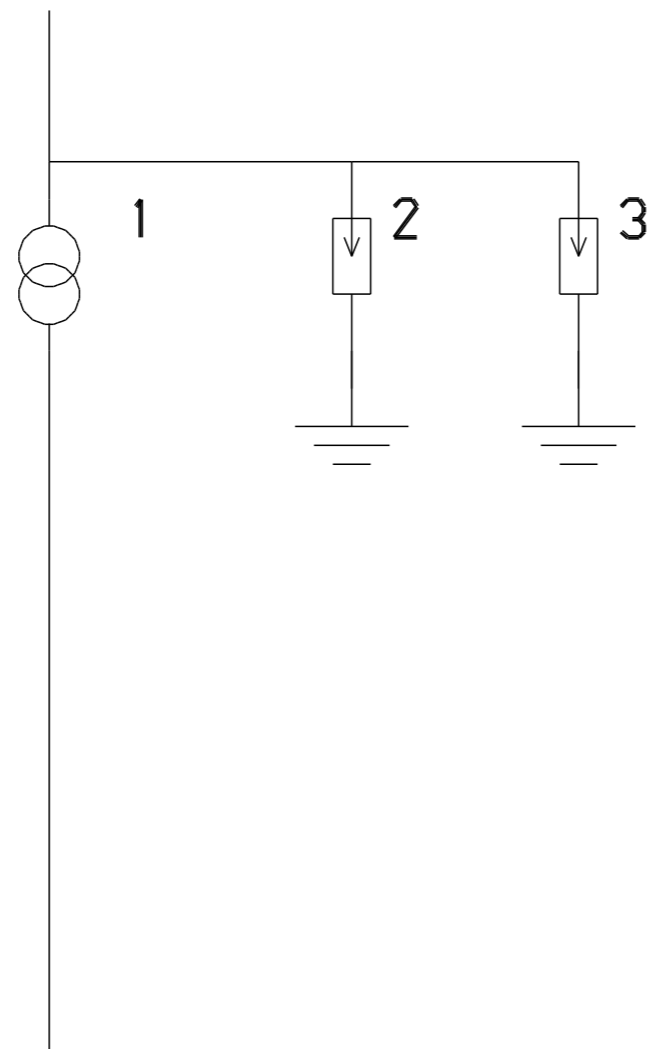

PRT\FVL\FVN - 2 MODULY

<_>\TVTWW

<_>\TVTWW



TFU\FU

TFU\FU

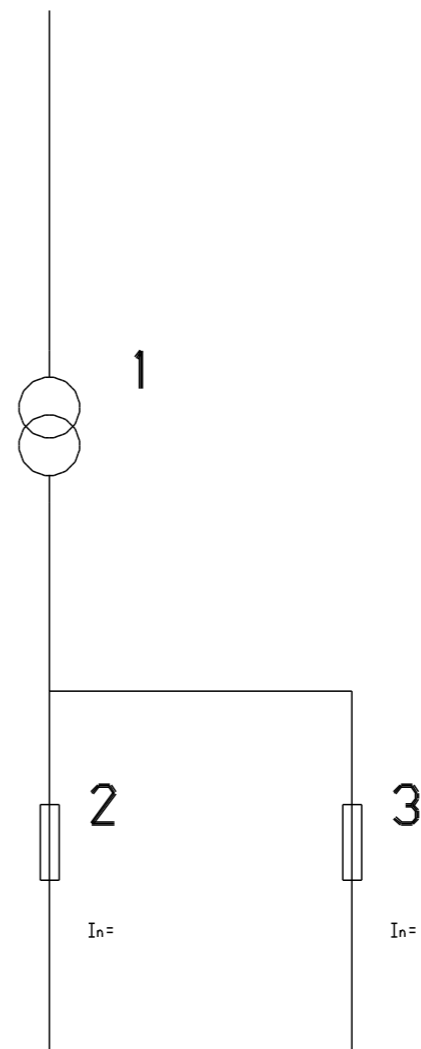

TFU\FU - 2 MODULY

PRTAA2TA40

PRTAA2TA40

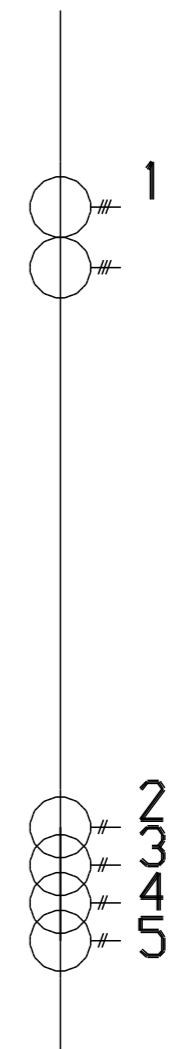

TQF

TQF

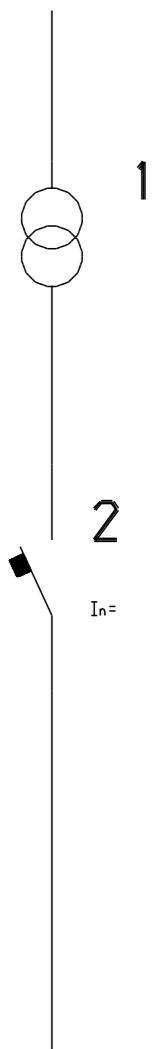

<>TAATA | <>TA1TAATA2 | <>TAATA1TA2 |
 <>TAATA <>TA1TAATA2 <>TAATA1TA2

TFU
 TFU

